

CONTENT

A-Z

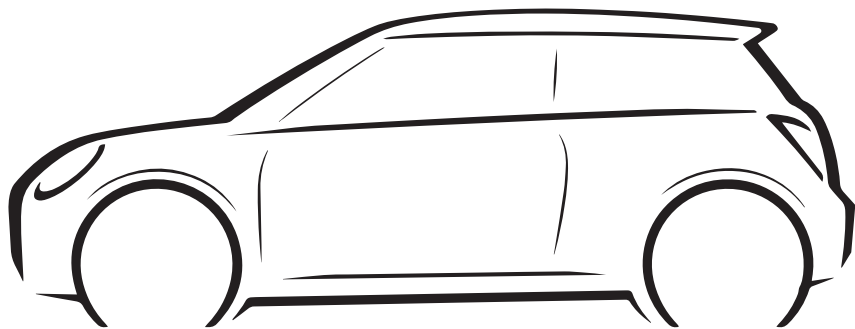

OWNER'S MANUAL.
MINI COOPER.





WELCOME TO MINI.

OWNER'S MANUAL.

Thank you for choosing a MINI.

The more familiar you are with the vehicle, the better control you will have on the road. We therefore strongly suggest the following:

Read this Owner's Manual before starting off in your new MINI. Also use the Integrated Owner's Manual in the vehicle. It contains important notes on vehicle operation that will help you make full use of the technical features available in your MINI. The manual also contains information designed to enhance operating reliability and traffic safety, and to contribute to maintaining the value of your MINI.

At the time of production at the plant, the printed Owner's Manual is the most current resource. The Integrated Owner's Manual for the vehicle will contain the latest information after the vehicle software is updated, e.g., after a MINI Remote Software Upgrade.

Get started now. We wish you driving fun and inspiration with your MINI.

TABLE OF CONTENTS

The Integrated Owner's Manual for the vehicle will contain the latest information after the vehicle software is updated, e.g., after a MINI Remote Software Upgrade.

! NOTES

Information.....	6
------------------	---

🔑 QUICK REFERENCE

Getting in.....	16
Set-up and use.....	19
On the road.....	22

👇 CONTROLS

Dashboard.....	30
Sensors of the vehicle.....	34
Operating state of the vehicle.....	39
Display and operating concept.....	43
MINI Remote Software Upgrade.....	55
Personal settings.....	59
Opening and closing.....	67
Seats, mirrors and steering wheel.....	94
Transporting children safely.....	109
Driving.....	115
Displays.....	131
Light and view.....	147
Safety.....	161
Driving stability control systems.....	193
Driver assistance systems.....	197
Parking.....	218
Driving comfort.....	243
Climate control.....	244

Interior equipment.....	256
Storage compartments.....	263
Cargo area.....	267

DRIVING TIPS

Things to remember when driving.....	274
Saving fuel.....	280

MOBILITY

Refueling.....	284
Wheels and tires.....	286
Engine compartment.....	315
Operating fluids.....	318
Maintenance.....	325
Replacing components.....	328
Breakdown Assistance.....	332
Vehicle care.....	341

REFERENCE

Technical data.....	346
Appendix.....	348
Everything from A to Z.....	350

Information

Using this Owner's Manual

Orientation

The fastest way to find information on a particular topic is by using the index.

For an overview of the vehicle, we recommend reading the Quick Reference Guide in the Owner's Manual.

Validity of the Owner's Manual

Production of the vehicle

At the time of production at the plant, the printed Owner's Manual is the most current resource.

Depending on the national-market version, there may be differences between the vehicle's printed Owner's Manual and the Integrated Owner's Manual due to updates made after going to print.

Notes on updates can be found in the appendix of the printed Owner's Manual for the vehicle.

After a software update in the vehicle

After a vehicle software update, for example, via Remote Software Upgrade, the Integrated Owner's Manual for the vehicle will contain the latest information, depending on the national-market version.

Before setting off, make sure that the Integrated Owner's Manual is available and up-to-date.

Owner's Manual for Navigation, Entertainment, Communication

The Owner's Manual for Navigation, Entertainment, and Communication can be ob-

tained as a printed book from an authorized service center.

The topics are also discussed in the Integrated Owner's Manual in the vehicle.

Media at a glance

General information

The contents of the Owner's Manual are available in various media formats. The following Owner's Manual media formats are available:

- Printed Owner's Manual.
- Integrated Owner's Manual in the vehicle.

Printed Owner's Manual

The printed Owner's Manual shows all standard, country-specific, and optional equipment that is currently available, or may become available in the future, for specific models.

Integrated Owner's Manual in the vehicle

Principle

The Integrated Owner's Manual shows all standard, country-specific, and optional equipment that is currently available, or may become available in the future, for specific models. The Integrated Owner's Manual can be displayed on the Interaction Unit.

Functional requirement

The Integrated Owner's Manual is provided depending on national-market version.

Selecting the Owner's Manual

1. Go through the menu as follows: Apps menu / "All" / "Owner's Manual".
2. Select the desired method for accessing the contents.

Scrolling through the Owner's Manual

Swipe up or down until the next or previous contents are displayed.

Context help

General information

The Integrated Owner's Manual can be accessed from any menu. Depending on the selected function, either the associated description or the main menu of the Integrated Owner's Manual will be displayed.

Selecting context help from a menu

1. Press and hold the desired menu item.
2. "General help"

Selecting context help from a Check Control message

Directly from the Check Control message on the Interaction Unit:

"Owner's Manual"

After a software update in the vehicle

After a vehicle software update, for example, via Remote Software Upgrade, the Integrated Owner's Manual for the vehicle will contain the latest information, depending on the national-market version.

Before setting off, make sure that the Integrated Owner's Manual is available and up-to-date.

Supplementary Owner's Manuals

Also follow the Supplementary Owner's Manuals, which are included in addition to the onboard literature.

Additional sources of information

Authorized service center

An authorized service center, e.g., a MINI dealer or service center, will be happy to answer any questions.

Internet

Vehicle information and general information on MINI, e.g., on technology, are available on the Internet: www.miniusa.com.

MINI Motorer's Guide app



The app shows all standard, country-specific, and optional equipment that is currently available, or may become available in the future, for specific models. The app can be displayed on smartphones and tablets.

MINI Motorer's Guide Web

The Driver's Guide website shows all standard, country-specific, and optional equipment that is currently available, or may become available in the future, for specific models. Driver's Guide Web can be displayed in any current browser.

Icons and displays

Icons in the Owner's Manual

Icon	Meaning
	Precautions that must be followed in order to avoid the possibility of injury to yourself and to others as well as serious damage to the vehicle.
	Measures that can be taken to help protect the environment.
"..."	Texts in vehicle used to select individual functions.
>...<	Verbal instructions to use with the voice activation system.
>>...<<	Responses generated by the voice activation system.

Action steps

Action steps to be carried out are presented as a numbered list. These steps must be carried out in the order shown.

1. First action step.
2. Second action step.

Bulletpoint lists

Items or actions without strict order or alternative options are shown as a bulletpoint list.

- First possibility.
- Second possibility.

Icons on vehicle parts

 This symbol on a vehicle component indicates that further information on the component is available in the Owner's Manual.

Vehicle features and options

This Owner's Manual shows all standard, country-specific, and optional equipment that is currently available, or may become available in the future, for specific models, i.e., model series. Therefore, this Owner's Manual also describes and illustrates equipment, systems and functions that are not available in a vehicle, for example due to the following situations:

- Selected optional equipment
- National-market version or national-market equipment
- Options for later release and software update

This also applies to safety functions and systems.

Before starting a journey, verify whether the described equipment or function is available in the vehicle. For information on whether a function is currently available in the vehicle or when the function can be installed in the vehicle, contact an authorized service center or another qualified service center or repair shop.

A claim for the availability of equipment, a system or a function in the vehicle cannot be derived based on the description in the Owner's Manual.

When using these functions and systems, the applicable laws and regulations must be observed.

For any equipment and models not described in this Owner's Manual, refer to the Supplementary Owner's Manuals.

An authorized service center is happy to answer any questions that you may have about the features and options applicable to the vehicle.

Status of the Owner's Manual

Basic information

The manufacturer of the vehicle pursues a policy of constant development to ensure that our vehicles continue to embody the highest quality and safety standards. In rare cases, therefore, the features described in this Owner's Manual may deviate from those in the vehicle.

Validity of the Owner's Manual

Production of the vehicle

At the time of production at the plant, the printed Owner's Manual is the most current resource.

Depending on the national-market version, there may be differences between the vehicle's printed Owner's Manual and the Integrated Owner's Manual due to updates made after going to print.

Notes on updates can be found in the appendix of the printed Owner's Manual for the vehicle.

After a software update in the vehicle

After a vehicle software update, for example, via Remote Software Upgrade, the Integrated Owner's Manual for the vehicle will contain the latest information, depending on the national-market version.

Before setting off, make sure that the Integrated Owner's Manual is available and up-to-date.

For Your Own Safety

Intended use

Heed the following when using the vehicle:

- Owner's Manual.
- Information on the vehicle. Do not remove stickers.
- Technical vehicle data.
- The traffic, speed, and safety laws where the vehicle is driven.
- Vehicle documents and statutory documents.

Warranty

The vehicle is technically configured for the operating conditions and registration requirements applicable in the country of first delivery, also known as homologation. If the vehicle is to be operated in a different country it might be necessary to adapt the vehicle to potentially differing operating conditions and registration requirements. Noncompliance with homologation requirements in a certain country may affect warranty coverage. Please consult the New Vehicle Limited Warranty Booklet for further information on warranty matters.

Maintenance and repairs

Advanced technology, for instance the use of modern materials and high-performance electronics, requires suitable maintenance and repair work.

The vehicle manufacturer therefore recommends having necessary work performed by an authorized service center, e.g., a MINI dealer or service center. If a different repair shop is selected, MINI recommends selecting a workshop that performs the appropriate work such as maintenance and repair according to MINI specifications with properly trained personnel. In the Owner's Manual, such workshops are referred to as "another qualified service center or repair shop".

If work is not carried out properly, for instance maintenance and repair, there is

a risk of subsequent damages and related safety risks.

Improperly performed work on the vehicle paintwork can lead to a failure or fault of components, e.g., the radar sensors, and thereby result in a safety hazard.

Parts and accessories

The manufacturer of the vehicle recommends the use of parts and accessory products approved by the manufacturer of the MINI.

Approved parts and accessories, and advice on their use and installation are available from an authorized service center.

MINI parts and accessories were tested by the manufacturer of the MINI for their safety and suitability in MINI vehicles.

The manufacturer of the vehicle warrants genuine MINI parts and accessories.

The manufacturer of the vehicle does not evaluate whether each individual product from another manufacturer can be used with MINI vehicles without presenting a safety hazard, even if a country-specific official approval was issued. The manufacturer of the vehicle does not evaluate whether these products are suitable for MINI vehicles under all usage conditions.

California Proposition 65 Warning

For vehicles sold in California, the law requires vehicle manufacturers to provide the following warning:

Warning

Engine exhaust and a wide variety of Automobile components and parts, including components found in the interior furnishings in a vehicle, contain or emit chemicals known to the State of California to cause cancer and birth defects and reproductive harm. In addition, certain fluids

contained in vehicles and certain products of component wear contain or emit chemicals known to the State of California to cause cancer and birth defects or other reproductive harm. Battery posts, terminals and related accessories contain lead and lead compounds. Batteries also contain other chemicals known to the State of California to cause cancer. Wash your hands after handling. Used engine oil contains chemicals that have caused cancer in laboratory animals. Always protect your skin by washing thoroughly with soap and water. For more information go to www.P65Warnings.ca.gov/passenger-vehicle.

Warning

Operating, servicing and maintaining a passenger vehicle or off-highway motor vehicle can expose you to chemicals including engine exhaust, carbon monoxide, phthalates, and lead, which are known to the State of California to cause cancer and birth defects or other reproductive harm. To minimize exposure, avoid breathing exhaust, do not idle the engine except as necessary, service the vehicle in a well-ventilated area and wear gloves or wash your hands frequently when servicing the vehicle. For more information go to www.P65Warnings.ca.gov/passenger-vehicle.

Service and warranty

We recommend that you read this publication thoroughly. The vehicle is covered by the following warranties:

- New Vehicle Limited Warranty.
- Rust Perforation Limited Warranty.
- Federal Emissions System Defect Warranty.

- Federal Emissions Performance Warranty.
- California Emission Control System Limited Warranty.

Detailed information about these warranties is listed in the New Vehicle Limited Warranty Booklet.

The vehicle has been specifically adapted and designed to meet the particular operating conditions and homologation requirements in your country and continental region in order to deliver the full driving pleasure while the vehicle is operated under those conditions. If you wish to operate the vehicle in another country or region, you may be required to adapt the vehicle to meet different prevailing operating conditions and homologation requirements. You should also be aware of any applicable warranty limitations or exclusions for such country or region. In such case, please contact Customer Relations for further information.

Maintenance

Maintain the vehicle regularly to sustain the road safety, operational reliability and the New Vehicle Limited Warranty.

Specifications for maintenance measures:

- MINI Maintenance system. Maintenance, refer to page 325.
- Maintenance Booklet, available online and accessible via a QR code in the New Vehicle Limited Warranty Booklet.
- Warranty and Service Guide Booklet for Canadian models.

If the vehicle is not maintained or is improperly maintained, this could result in serious damage to the vehicle.

A failure to maintain the vehicle or improper maintenance may affect your warranty coverage. Please consult the New Ve-

hicle Limited Warranty Booklet for further information on warranty matters.

Refer to section on engine oil change regarding recommended service intervals for oil changes.

Data memory

General information

Electronic control devices are installed in the vehicle. Electronic control units process data they receive from vehicle sensors, self-generate or exchange with each other. Some control units are necessary for the vehicle to function safely or provide assistance while driving, for instance driver assistance systems. Furthermore, control units facilitate comfort or infotainment functions.

Information about stored or exchanged data can be requested from the manufacturer of the vehicle, in a separate booklet, for example.

Personal reference

Each vehicle is marked with a unique vehicle identification number. Depending on the country, the vehicle owner can be identified with the vehicle identification number, license plate and corresponding authorities. In addition, there are other ways to associate data collected from the vehicle with the driver or vehicle owner, e.g., the MINI Connected account used.

Operating data in the vehicle

Control units process data to operate the vehicle.

For example, this includes:

- Status messages for the vehicle and its individual components, e.g., wheel RPM,

wheel speed, deceleration, lateral acceleration, engaged seat belt indicator.

- Ambient conditions, e.g., temperature, rain sensor signals.

The processed data is only processed in the vehicle itself while the vehicle is being operated. Data is not stored beyond the operating time.

Electronic components, e.g. control units and vehicle keys, contain components for storing technical information. Information about the vehicle condition, component usage, maintenance recommendations, events or faults can be stored temporarily or permanently.

This information generally documents the state of a component, a module, a system, or the surrounding area, for instance:

- Operating states of system components such as fill levels, tire pressure, battery status.
- Malfunctions and faults in important system components, for instance lights and brakes.
- Responses by the vehicle to special driving situations such as airbag deployment or engagement of the driving stability control systems.
- Information on vehicle-damaging events.

The data is required to perform the control unit functions. Furthermore, it also serves to detect and correct malfunctions, and helps the vehicle manufacturer to optimize vehicle functions.

The majority of this data is stored temporarily and is only processed within the vehicle itself. In some circumstances the vehicle may store some data for an additional but limited period of time.

When servicing, for instance during repairs, service processes, warranty cases, and quality assurance measures, this technical in-

formation can be read out from the vehicle together with the vehicle identification number.

An authorized service center or another qualified service center or repair shop can read out the information. The diagnostic socket required by law in the vehicle is used to read out data.

The data is collected, processed, and used by the relevant organizations in the service network. The data documents technical conditions of the vehicle, which can be used to determine vehicle maintenance status, and facilitate quality improvement.

Vehicle fault and event memories can be reset by an authorized service center or another qualified service center or repair shop when performing repair or servicing work.

Data entry and data transfer into the vehicle

General information

Depending on the vehicle equipment, comfort and individual settings can be stored in the vehicle and modified or reset at any time.

For example, this includes:

- Settings for the seat and steering wheel positions.
- Chassis and climate control settings.

If necessary, data can be transferred to the entertainment and communication system of the vehicle, for instance via smartphone.

This includes the following depending on the respective equipment:

- Multimedia data such as music, films or photos for playback in an integrated multimedia system.
- Address book data for use in conjunction with an integrated hands-free system or an integrated navigation system.

- Entered navigation destinations.
- Data on the use of Internet services.

This data can be stored locally in the vehicle or is found on a device that has been connected to the vehicle, e.g., a smartphone, USB stick or MP3 player. If this data is stored in the vehicle, it can be deleted at any time.

This data is only transmitted to third parties upon personal request as part of the use of online services. The transmission depends on the selected settings for the use of the services.

Incorporation of mobile devices

Depending on the vehicle equipment, mobile devices connected to the vehicle, for instance smartphones, can be controlled via the vehicle operating elements.

The sound and picture from the mobile devices can be played back and displayed through the multimedia system. Certain information is transferred to the mobile devices at the same time. Depending on the type of incorporation, this includes, for instance, position data and other general vehicle information. This optimizes the way in which selected apps, for instance navigation or music playback, work.

There is no further interaction between the mobile device and the vehicle such as active access to vehicle data.

How the data will be processed further is determined by the provider of the particular app being used. The extent of the possible settings depends on the respective app and the operating system of the mobile device.

Services

General information

If the vehicle has a wireless network connection, it will enable data to be exchanged between the vehicle and other systems. The

wireless network connection is realized via an in-vehicle transmitter and receiver unit or via personal mobile devices brought into the vehicle, for instance smartphones. This wireless network connection enables 'online functions' to be used. These include online services and apps supplied by the vehicle manufacturer or by other providers.

Services from the vehicle manufacturer

Where online services from the vehicle manufacturer are concerned, the corresponding functions are described in the appropriate place, for instance the Owner's Manual or manufacturer's web page. The relevant legal information pertaining to data protection may also be found on the manufacturer's website. Personal data may be used to perform online services. Data is exchanged over a secure connection, for instance with the IT systems of the vehicle manufacturer intended for this purpose.

Any collection, processing, and use of personal data above and beyond that needed to provide the services must always be based on a legal permission, contractual arrangement or consent. It is also possible to activate or deactivate the data connection as a whole. This excludes functions and services required by law such as Assist systems.

Services from other providers

When using online services from other providers, these services are the responsibility of the relevant provider and subject to their data privacy conditions and terms of use. The vehicle manufacturer has no influence on the content exchanged during this process. Information on the way in which personal data is collected and used in relation to services from third parties, the scope of such data, and its purpose, can be obtained from the relevant service provider.

Event Data Recorder (EDR)

This vehicle is equipped with an event data recorder (EDR). The main purpose of an EDR is to record, in certain crash or near-crash-like situations such as an air bag deployment or hitting a road obstacle, data that will assist in understanding how a vehicle's systems performed. The EDR is designed to record data related to the driving dynamics and safety systems for a short time: max. 30 seconds, typically less.

The EDR in this vehicle is designed to record the following data, for example:

- How various systems in the vehicle were operating.
- Whether or not the driver and passenger seat belts were fastened.
- How far, if at all, the driver was depressing the accelerator and/or brake pedal.
- How fast the vehicle was traveling.

This data can help provide a better understanding of the circumstances in which crashes and injuries occur.

EDR data is recorded by the vehicle only if a nontrivial crash situation occurs; no data is recorded by the EDR under normal driving conditions and no personal data, for instance name, gender, age, and crash location, are recorded.

However, other parties such as law enforcement could combine the EDR data with the type of personally identifying data routinely acquired during a crash investigation.

To read data recorded by an EDR, special equipment is required, and access to the vehicle or the EDR is needed. In addition to the vehicle manufacturer, other parties such as law enforcement that have the special equipment can read the information if they have access to the vehicle or the EDR.

Vehicle identification number

General information

Depending on the national-market equipment, the vehicle identification number is located in different positions in the vehicle. This chapter describes all possible positions for the series.

Engine compartment



The engraved vehicle identification number can be found in the engine compartment, on the right-hand side of the vehicle.

Right nameplate



The vehicle identification number can be found on the nameplate, on the right-hand side of the vehicle.



Left nameplate



The vehicle identification number can be found on the nameplate, on the left-hand side of the vehicle.

Windshield



The vehicle identification number can also be found behind the windshield.

Reporting safety defects

For US customers

The following only applies to vehicles owned and operated in the US.

If you believe that the vehicle has a defect which could cause a crash or could cause injury or death, you should immediately inform the National Highway Traffic Safety Administration NHTSA, in addition to notifying MINI of North America, LLC, P.O. Box 1227, Westwood, New Jersey 07675-1227, Telephone 1-800-831-1117.

If NHTSA receives similar complaints, it may open an investigation, and if it finds that a safety defect exists in a group of vehicles, it may order a recall and remedy campaign.

However, NHTSA cannot become involved in individual problems between you, your dealer, or MINI of North America, LLC.

To contact NHTSA, you may call the Vehicle Safety Hotline toll-free at 1-888-327-4236 (TTY: 1-800-424-9153); go to <http://www.safercar.gov>; or write to: Administrator, NHTSA, 1200 New Jersey Avenue, SE., Washington, DC 20590. You can also obtain other information about motor vehicle safety from <http://www.safercar.gov>.

For Canadian customers

Canadian customers who wish to report a safety-related defect to Transport Canada, Defect Investigations and Recalls, may call the toll-free hotline 1-800-333-0510. You can also obtain other information about motor vehicle safety from <http://www.tc.gc.ca/roadsafety>.

Getting in

Opening and closing

Vehicle key



Buttons on the vehicle key.

Icon	Meaning
	Unlock.
	Lock. Stationary climate control, refer to page 253.
	Unlock the trunk.
	Panic mode. Pathway lighting, refer to page 153.

Accessing the vehicle interior

Unlocking with the vehicle key

Press the unlock button on the vehicle key.

If only the driver's door and fuel filler flap have been unlocked due to the settings in place, press the button on the vehicle key

again to unlock the other vehicle access points.

After opening one of the front doors, the vehicle is ready for operation.

Locking with the vehicle key

1. Close the driver's door.

2. Press the lock button on the vehicle key.

All vehicle access points are locked.

Buttons for the central locking system

Overview

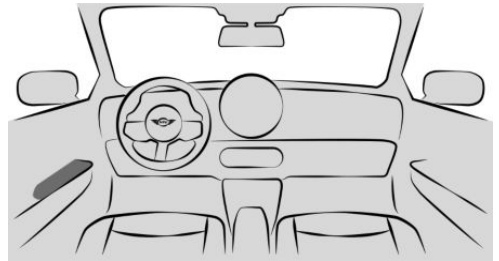

The central locking system buttons are located on the driver's door.

Locking the vehicle

With the doors closed, press the lock button on the driver's door.

The fuel filler flap remains unlocked.

The vehicle is not secured against theft when locking.



Unlocking the vehicle



Press the unlock button on the driver's door.

Panic mode

You can trigger the alarm system if you find yourself in a dangerous situation.

-  Press and hold the panic mode button on the vehicle key for at least 3 seconds.
-  Press the panic mode button on the vehicle key three times in quick succession.

To switch off the alarm: press any button.

Access to the cargo area

Opening the cargo area

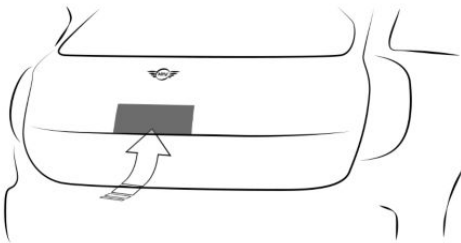

Unlock the vehicle, then press the unlock button on the outside of the trunk.

Swivel the tailgate upward.

Closing the cargo area

Grasp the recessed grips and pull the tailgate down.

Displays, operating elements

In the vicinity of the steering wheel



- 1 Lights
- 2 Wipers
- 3 Horn

Indicator/warning lights

The indicator/warning lights can illuminate in a variety of combinations and colors.

Several of the lights are checked for proper functioning and illuminate temporarily when drive-ready state is turned on.

Driver's door

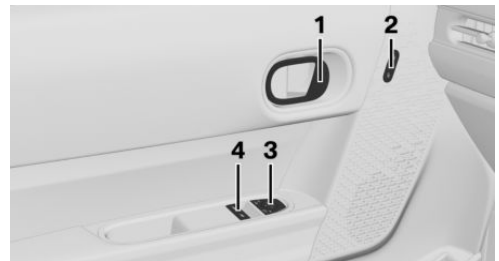

- 1 Opening the door
- 2 Central locking system
- 3 Exterior mirror adjustment button
- 4 Power windows



Switch console

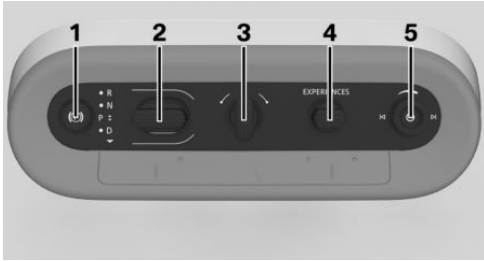

- 1 Parking brake
- 2 Selector lever
- 3 Start/Stop switch
- 4 MINI Modes
- 5 Volume button

MINI Interaction Unit

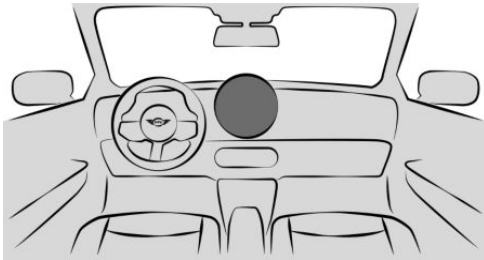

The Interaction Unit is located on the instrument panel above the center console.

Principle

The Interaction Unit consists of a central round display with functions that can be operated by touch.

The Interaction Unit's main menu is divided into different areas, e.g., menu bar, status information, and widgets.

MINI Intelligent Personal Assistant

Principle

The MINI Intelligent Personal Assistant is a personal assistant that operates various vehicle functions by means of natural spoken commands.

Activating the voice control system

1.  Briefly press the microphone button on the steering wheel.
2. Say the desired command.

Canceling voice control

-  Press the microphone button on the steering wheel again.
- Say the following command: ›Cancel‹

Set-up and use

Seats, mirrors and steering wheel

Manually adjustable seats



- 1 Longitudinal direction
- 2 Height
- 3 Backrest tilt

Electrically adjustable seats

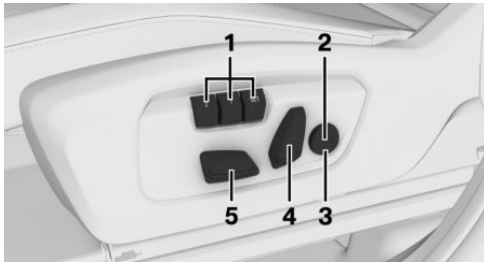

- 1 Memory function
- 2 Lumbar support
- 3 Seat massage
- 4 Backrest tilt
- 5 Longitudinal direction/height/seat tilt

Adjusting the head restraint

Adjusting the height

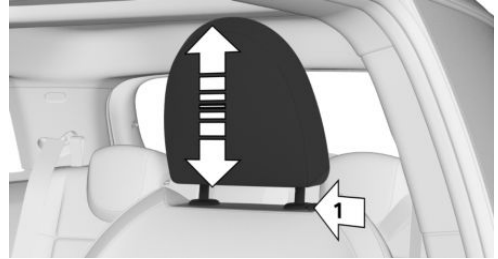

- To raise the height of the head restraint, push the head restraint upward.
- To lower the height of the head restraint, press the release button on the backrest, arrow 1, then push the head restraint downward.

Adjusting the distance

The backrest tilt is used to set the distance between the head restraint and the back of the seat occupant's head.

Adjust the distance so that the head restraint is as close as possible to the back of the head.

Adjusting the exterior mirrors





Icon	Meaning
	Fold the exterior mirror in and out.
	Adjust the exterior mirrors.
	Select left exterior mirror.
	Select right exterior mirror.

Adjusting the steering wheel

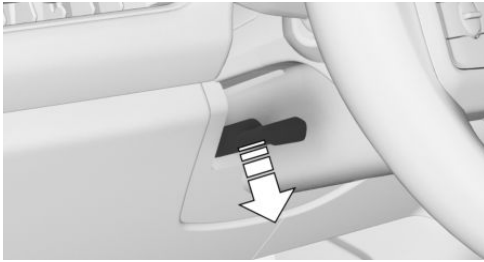

1. On the steering column, press the release lever all the way down.
2. Grip the steering wheel with both hands and move the steering wheel to the preferred height and angle to suit your seat position.
3. Fold the lever back up.

Memory function

Principle

The following settings can be stored and, if necessary, retrieved using the memory function:

- Seat position.
- Exterior mirror adjustment.
- Depending on the equipment: height of the Head-up display.

Overview



The memory buttons are located on the front seats.

Storing settings

1. Set the desired position.
2. Press the SET button on the seat. The LED illuminates.
3. Press memory button 1 or 2 while the LED is illuminated. A successful save is indicated by a signal tone.

Calling up settings

Press the desired memory button 1 or 2.

Infotainment



Navigation and guidance

Guidance can be started via the quick search.

1. Go to the Navigation menu.
2. Select the search field.
3. Enter your desired destination.
4. Start destination guidance.
More information may be displayed.

Entertainment

The following operating elements are provided on the switch cluster and Interaction Unit:

Button	Function
	<p>Turn the volume button to adjust the volume.</p> <p>Press the volume button to turn off sound output. Pressing the button again restores the previous volume.</p> <p>Push the volume button once to left/right: Change station/track.</p>
	Change the entertainment source.

Using the mobile phone

General information

Once a mobile phone connects with the vehicle, this mobile phone can be operated using the Interaction Unit and steering wheel buttons.

Activate Bluetooth® on the mobile phone.

Connecting via Bluetooth®

A mobile phone can be paired with the vehicle via Bluetooth.

1. Go through the menu as follows: Apps menu / "All" / "Mobile devices" / "Connect new device".

The Interaction Unit shows any mobile phones that are within range.

2. Select the desired mobile phone.
3. Compare the control number shown on the Interaction Unit with the control

number on the mobile phone's display and make sure that they match.

4. If necessary, select connection mode: "Continue with MINI Interaction Unit"

The device is connected and displayed in the device list.

Accepting a call

Depending on the equipment, incoming calls can be answered in several ways.

- Via the Interaction Unit:

 "Accept"

-  Press the telephone function button on the steering wheel.

Dialing a number

The Interaction Unit can be used to dial a telephone number.

1. Go through the menu as follows: Apps menu / "All" / "Telephone" / "Dial".
2. Enter the desired digits.
3.  Select the icon for calling. The connection is established via the mobile phone to which this function has been assigned.

On the road

Driving

Drive-ready state

Turning on the drive-ready state

1. Depress the brake pedal.
2.  Turn the Start/Stop button on the switch cluster.

Turning off drive-ready state

After stopping the vehicle:

1. Apply the brake and push the parking brake button.
2.  On the switch cluster, turn the Start/Stop button.
The READY indicator goes out and a signal tone sounds.

The drive-ready state is switched off automatically if the driver's seat belt is not buckled when the driver's door is opened.

Auto Start/Stop function

The Auto Start/Stop function switches the engine off automatically while stationary to save fuel. The engine starts automatically under the following preconditions:

- By releasing the brake pedal.
- When Automatic Hold is activated: step on the accelerator pedal.

Steptronic transmission

Engaging a selector lever position

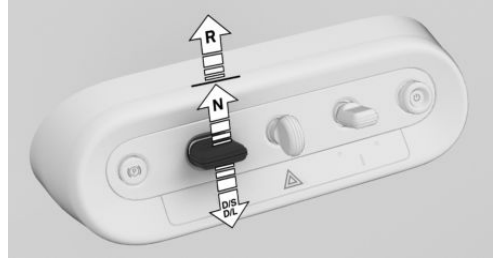

- D is drive.
- N Neutral.
- Reverse R.
- With shift paddles: S is Sport program.
- Without shift paddles: L LOW mode.

To prevent the vehicle from moving after engaging drive or reverse, maintain pressure on the brake pedal until you are ready to drive off.

Only engage selector lever position R when the vehicle is stationary.

Sport program: Shift characteristics are designed for sportier driving.

LOW mode: the engine braking effect is increased and acceleration is quicker.

Engaging selector lever position P

Only push the parking brake button when the vehicle is stationary.



 To engage selector lever position P and the parking brake, press the parking brake button on the switch cluster.

The parking brake is applied and the transmission lock is engaged.

Parking brake

Setting the parking brake

 To engage the parking brake, press the parking brake button on the switch cluster.

The LED illuminates.

The parking brake is engaged and transmission lock is engaged.

Releasing the parking brake

 Press the parking brake button with selector lever position P engaged and drive-ready state on.

The LED and the indicator light go out.

The parking brake is released.

Parking

Make sure the parking brake is engaged.

Light and view

Turn signal, high-beam headlights, headlight flasher

Turn signal

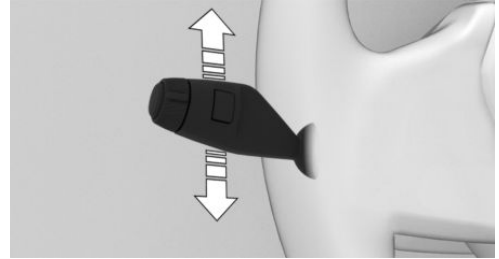

- To flash the turn signal, push the turn signal lever up or down past the resistance point.
- For one-touch signaling: Lightly tap the turn signal lever up or down.
- To flash the turn signal briefly: Push the turn signal lever to the resistance point and hold it there for as long as you wish to indicate a turn.

High-beam headlights, headlight flasher

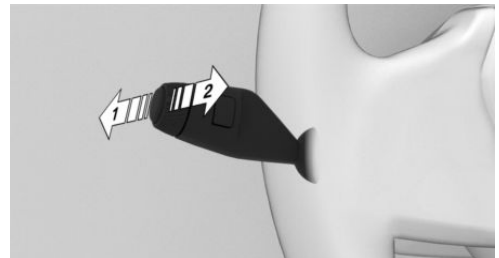

- To turn on the high-beam headlights, push the turn signal lever forward, arrow 1.







The high-beam headlights illuminate when the low-beam headlights are switched on.





- To turn off the high-beam headlights or operate the headlight flasher, pull the turn signal lever backward, arrow 2.



Lights and lighting

Buttons on turn signal lever

Icon	Function
	Exterior lighting menu.
	Low-beam headlights.
	Automatic headlight control.
	Exterior lighting off.

Functions via the Interaction Unit

Icon	Function
	Automatic headlight control.
	Low-beam headlights.
	Exterior lighting off.
	Automatic High Beam Assistant.
	Parking lights.

Icon	Function
	Left roadside parking light.
	Right roadside parking light.

Window wiper system

Turning on window wiper system

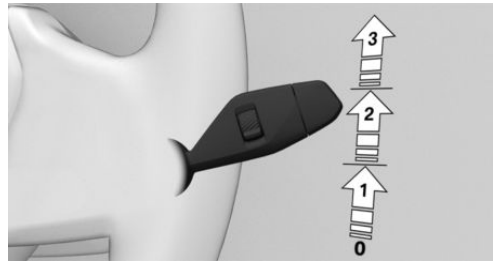

To turn on the wiper system, push the wiper lever upward to the desired position.

Position	Function
Position 0.	Rest position of wipers.
Position 1.	Rain sensor mode.
Position 2.	Normal wiper speed.
Position 3.	Fast wiper speed.

Turning off the window wiper system and flick wipe

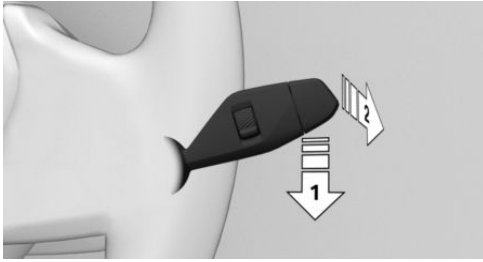

To turn off the wipers or to activate flick wiping, proceed as follows:

- To turn off: Push the wiper lever downward, arrow 1, until position 0 is reached.
- To flick wipe: Push the wiper lever downward from position 0, arrow 1, and push the wiper lever forward to position 0 or position 1, arrow 2.

The wiper lever returns to its initial position when released.

Activating/deactivating rain sensor

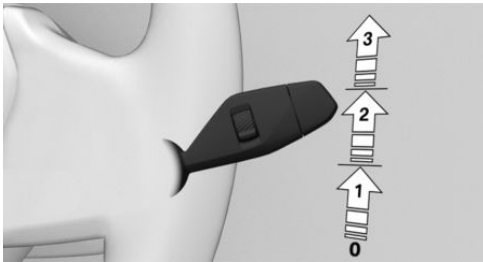

To activate the rain sensor: Push the wiper lever upward from position 0, arrow 1, once.

To deactivate the rain sensor: Push the wiper lever back to position 0.

Adjusting the rain sensor sensitivity

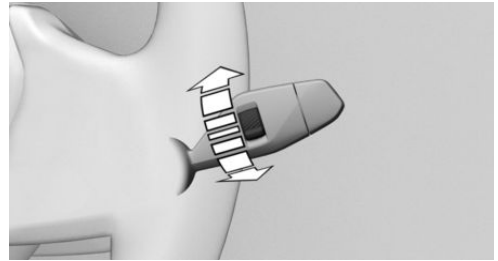

To adjust the sensitivity of the rain sensor, turn the knurled wheel on the wiper lever.

Cleaning the windshield

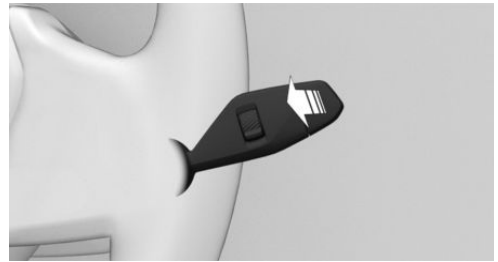

To clean the windshield, pull the wiper lever back.

Rear wiper

Switching on the rear wiper

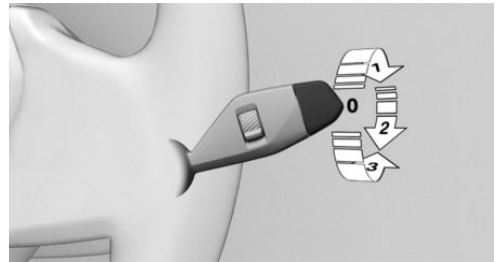

To turn on the rear wiper, rotate the outer switch on the wiper lever upward.

Switch position	Function
Position 0.	Rest position of the wiper.
Position 1.	Intermittent operation. When reverse gear is engaged, the system switches to continuous operation.

Clean the rear window





To clean the rear window, turn the outer switch on the wiper lever as follows:









- In rest position: Turn the switch downward, arrow 3. The switch returns to its rest position when released.
- In intermittent operation: Turn the switch further, arrow 2. The switch automatically returns to its interval position when released.

Climate control

Climate control functions

Functions in the Climate menu



Icon	Function
	Turn the climate control system on/off.
	Automatic program.
	Temperature.
	Air flow.

Icon	Function
	Air distribution.
	Air conditioning.
	Maximum cooling.
	Air recirculation mode.
	Automatic recirculated-air control.
	Fresh air.
	SYNC program.
	Seat heating.
	Steering wheel heating.

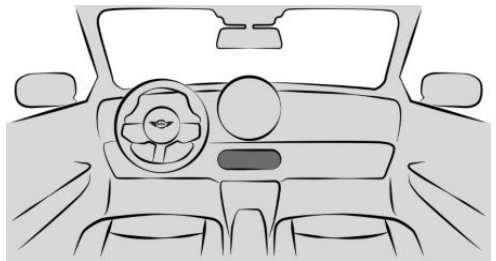
Buttons, automatic climate control





Icon	Function
	Defrost function.
	Rear window defroster.

Intermediate stop

Refueling

Fuel filler cap

1. To open the fuel filler flap, press on the rear edge, arrow. The fuel filler flap opens.



2. Open the fuel filler cap counterclockwise.

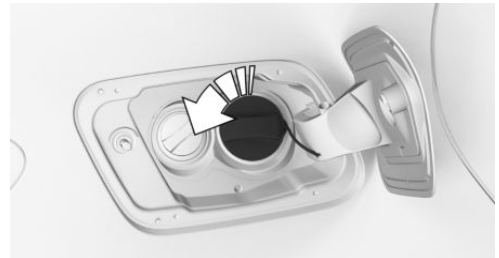

3. Place the fuel filler cap in the bracket on the fuel filler flap.

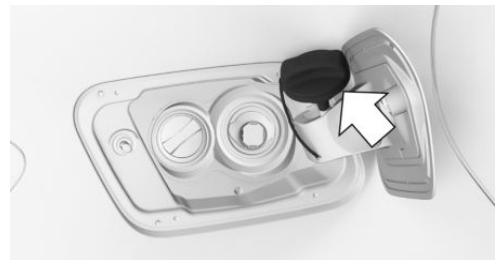

Wheels and tires

Tire pressure specifications

The tire pressure table contains all tire inflation pressure specifications for given tire sizes at ambient temperature.

After correcting the tire pressure

If vehicle is equipped with the Tire Pressure Monitor, corrected tire pressures are applied automatically. Make sure that the correct tire settings have been made. When using tires not listed in the tire inflation pressure specifications on the Interaction Unit, reset the Tire Pressure Monitor.

If equipped with a flat tire monitor, reinitialize the flat tire monitor.

Checking the tire pressure

Regularly check the tire inflation pressure and correct it as needed:

- At least twice a month.
- Before embarking on an extended trip.

Electronic oil measurement

Functional requirements

A current measured value is available after approx. 30 minutes of normal driving with the combustion engine running.

Displaying the engine oil level

To bring up the engine oil level, go through the menu as follows: Apps menu / "Vehicle" / "Vehicle status" / "Engine oil level".

The engine oil level is displayed.

Adding engine oil

General information

Safely park the vehicle and switch off drive-ready state before adding engine oil.

Adding engine oil

1. Opening the hood.
2. Open the lid counterclockwise.



3. Add engine oil.
4. Close the lid.

Providing assistance

Hazard warning system

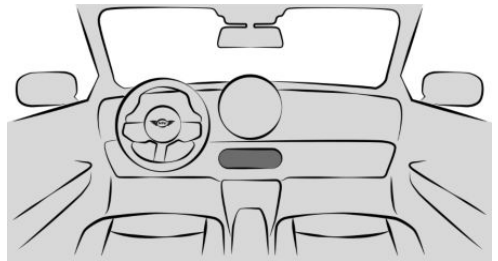

 The hazard warning system button is located on the switch cluster.

MINI Connected

MINI Assistance

Contact MINI Assistance for information and support for all aspects of the vehicle.

1. Go through the menu as follows: Apps menu / "All" / "MINI Assist".
2. Select the desired service, as necessary.
A voice connection to the selected service is established.

MINI Teleservices

Teleservices are services that help to maintain vehicle mobility.

Teleservices can comprise the following services:

- MINI Roadside Assistance.
- MINI Accident Assistance.
- Teleservice Call.
- An authorized service center.

Dashboard

Vehicle features and options

This chapter describes model-specific equipment, systems, and functions that are currently available, or may become available







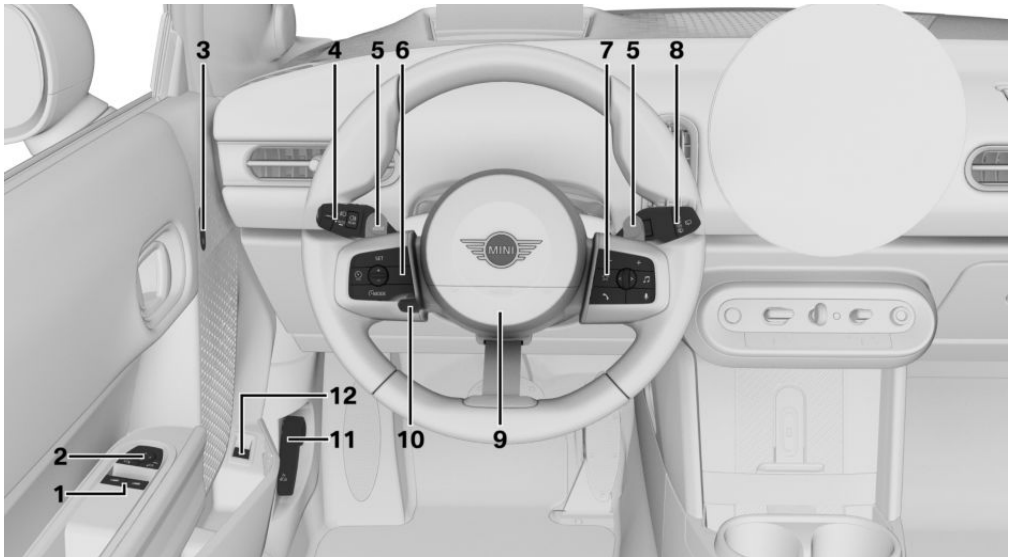

in the future, even if they are not present in the vehicle.



















Additional information:

Vehicle equipment, refer to page 8.

In the vicinity of the steering wheel



- 1  Power windows [87](#)
- 2 Exterior mirror adjustment button [104](#)
- 3 Buttons for the central locking system [83](#)
 -  Unlocking
 -  Locking
- 4 Turn signal lever and light
 -  Exterior lighting menu [150](#)
 -  Automatic High Beam Assistant [148](#)
 -  Driving lights automatic [151](#)
 -  Low-beam headlights [151](#)
 -  Adaptive lighting functions [154](#)
 - Exterior lighting off [151](#)

-  Turn signal [147](#)
-  High-beam headlights, headlight flasher [147](#)
- 5 Shift paddles [121](#)
Sport Boost function [123](#)
- 6 Steering wheel buttons, left
-  Turn speed control systems on/off [199](#)
-  Select speed control system [199](#)
-  Store speed [199](#)
-  Adjusting the speed [199](#)
- 7 Steering wheel buttons, right
-  Shortcuts [46](#)
-  Volume, see Owner's Manual for Navigation, Entertainment and Communication [6](#)
-  Audio, see Owner's Manual for Navigation, Entertainment, Communication [6](#)
-  Voice control, MINI Intelligent Personal Assistant [49](#)
-  Telephone, see Owner's Manual for Navigation, Entertainment and Communication [6](#)
-  Using selection lists [141](#)
Accessing and resetting trip data [131](#)
- 8 Wiper lever
-  Wipers [157](#)
-  Rain sensor [158](#)
-  Cleaning the windshield [158](#)
-  Rear wiper in Canadian models [159](#)
-  Rear wiper [159](#)
-  Clean the rear window [159](#)
- 9  Horn, entire surface
- 10 Adjusting the steering wheel [106](#)
- 11 Unlocking the hood [316](#)
- 12 Unlocking the trunk [77](#)

In the vicinity of the center console

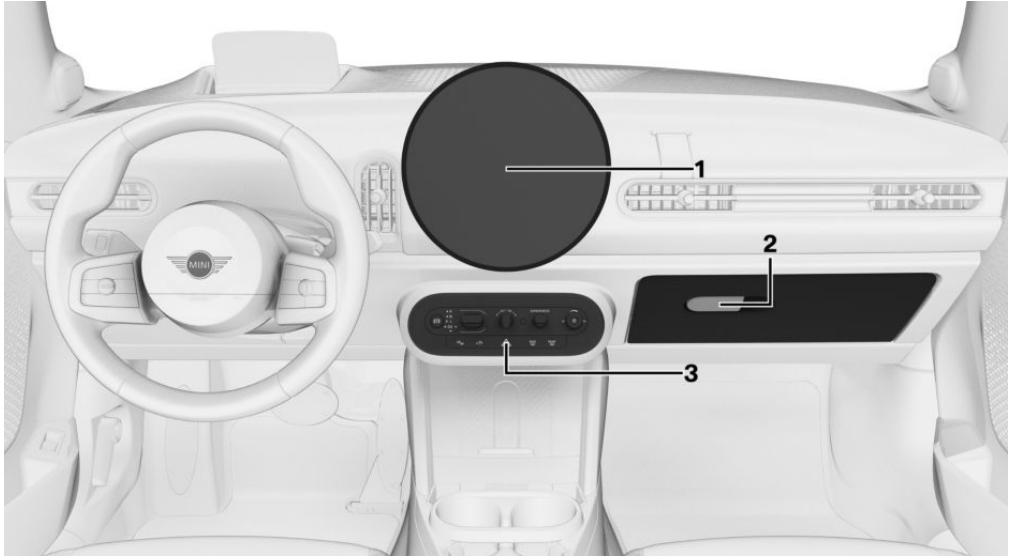

- 1 MINI Interaction Unit [43](#)
- 2 Glove compartment [263](#)
- 3 Switch console



Parking brake [126](#)



Selector lever [118](#)



Turning drive-ready state on/off [115](#)



MINI Modes [124](#)



Volume button, see Owner's Manual for Navigation, Entertainment, Communication [6](#)



Vehicle settings menu [49](#)



Parking assistance systems [218](#)



Hazard warning system [332](#)



Defrost function [249](#)







Rear window defroster [250](#)

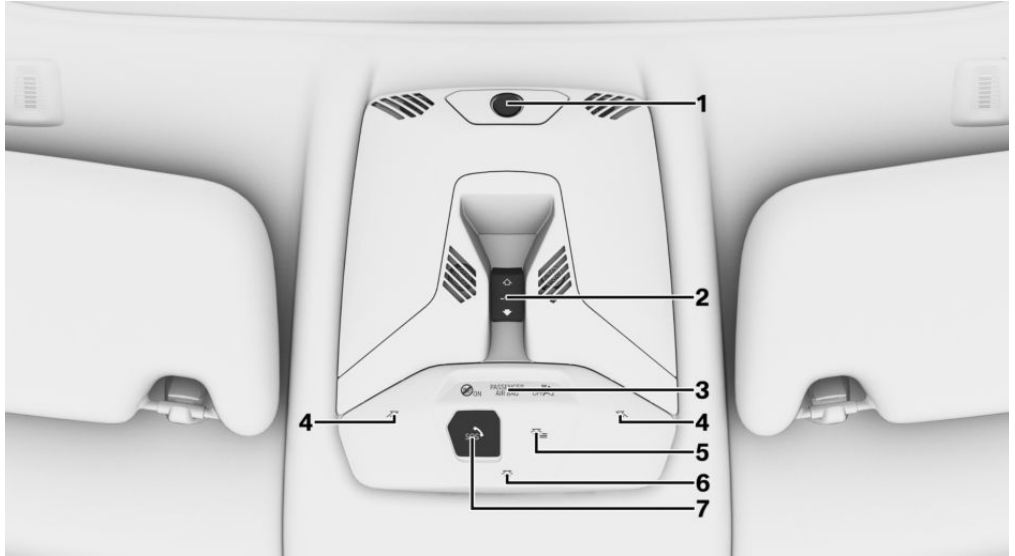

In the vicinity of the headliner



- | | | | | | |
|---|---|---------------------|-----|--|--|
| 1 | Interior camera | 259 | | | |
| 2 | Glass sunroof | 90 | | | |
| 3 |  Indicator light, front passenger airbag | 163 | | | |
| 4 |  Reading lights | 155 | | | |
| 5 |  Interior lighting menu | 49 | | | |
| 6 |  Interior lights | 155 | | | |
| 7 |  SOS | Emergency Call, SOS | 334 | | |

Sensors of the vehicle

Vehicle features and options

This chapter describes model-specific equipment, systems, and functions that are currently available, or may become available in the future, even if they are not present in the vehicle.

Additional information:

Vehicle equipment, refer to page 8.

Overview

Depending on the equipment, the following cameras and sensors are installed in the vehicle:

- Front camera.
- Camera behind the windshield.
- Exterior mirror cameras.
- Rearview camera.
- Front radar sensor.
- Side radar sensors, rear.
- Ultrasonic sensors in the front/rear bumpers.
- Ultrasonic sensors at the sides.

Cameras

Front camera

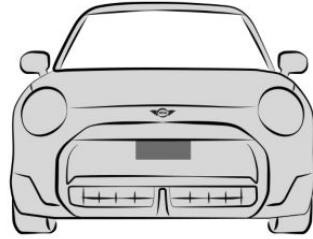

The front camera is located above the license-plate carrier.

Camera behind the windshield



The camera behind the windshield is located near the interior mirror.

Top view cameras

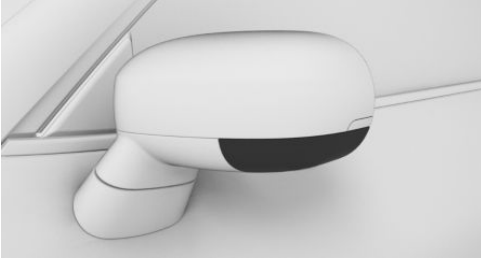

One exterior mirror camera is located at the bottom of each exterior mirror housing.

Rearview camera



The rearview camera is located in the handle strip on the rear of the vehicle.

Functional requirement of the cameras

For the cameras to function correctly, the area around the cameras must be clean and free.

Additional information:

- Washing the vehicle, refer to page 341.
- Vehicle care, refer to page 342.

System limits of the cameras

The cameras may not work properly, e.g., show something that is incorrect, in the following situations:

- In heavy fog, wet conditions, or snow-fall.
- On steep hilltops or in sharp dips in the road.
- In tight curves.
- When the camera field of view is covered, for instance by a fogged up windshield or labels.
- If the camera lens is dirty or damaged.
- With exterior mirrors folded in.
- With open doors or open cargo area.
- When driving toward bright lights or strong reflections, e.g., setting sun.
- When it is dark outside.
- The camera has overheated due to excessive temperatures and temporarily turned off.
- During calibration of the camera immediately after vehicle delivery.

If applicable, a Check Control message will be displayed when the system limits are reached.

Radar sensors

Safety information

Warning

The vehicle radar sensors and thus also the driver assistance systems can be impaired by external influences, e.g., interference. There is a risk of accident, injury, or property damage. Watch the surrounding traffic situation closely, be ready to take over steering and braking at any time, and actively intervene where appropriate.



Front radar sensor



The front radar sensor is located above the license-plate carrier.

Radar sensors, side, rear



The radar sensors are located on the side of the rear bumper.

Functional requirement of the radar sensors

For the radar sensors to function correctly, the area around the radar sensors must be kept clean and free.

Additional information:

- Washing the vehicle, refer to page [341](#).
- Vehicle care, refer to page [342](#).

System limits of the radar sensors

The function of the radar sensors may be restricted or not available, for instance in the following situations:

- In case of dirty sensors.
- In case of iced-up sensors.
- If sensors are covered such as by labels, films or a license-plate carrier.
- If the sensor is not aligned correctly, for instance due to parking damage.
- If the radiation range of the sensors is covered, e.g., by protruding cargo.
- When the field of view of the sensors is covered, e.g., by garage walls, hedges, snow hills, vehicles or trailers.
- After improper paint work on the vehicle in the area of the sensors.
- On steep hilltops or in sharp dips in the road.

If applicable, a Check Control message will be displayed when the system limits are reached.

Ultrasonic sensors

Ultrasonic sensors, front

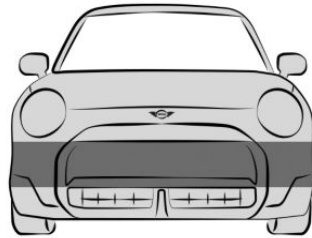

The ultrasonic sensors of the parking assistance systems are located in the front bumper.

Ultrasonic sensors, rear



The ultrasonic sensors of the parking assistance systems are located in the rear bumper.

Ultrasonic sensors, side



The ultrasonic sensors for the parking assistance systems are located on the sides of the front and rear bumpers.

Functional requirement of the ultrasonic sensors

For the ultrasonic sensors to function correctly, the area around the ultrasonic sensors must be kept clean and free.

Additional information:

- Washing the vehicle, refer to page [341](#).
- Vehicle care, refer to page [342](#).

System limits of the ultrasonic sensors

The detection of objects with ultrasonic measurements can run into physical limits, e.g., in the following situations:

- If the sensors are dirty or covered, e.g., by stickers.
- If the sensor is not aligned correctly, for instance due to parking damage.
- After improper paint work on the vehicle in the area of the sensors.
- For small children and animals.
- For people with specific clothing, e.g., coat.
- With obstacles and persons at the edge of the lane.
- In case of external interference with the ultrasonics, for instance from passing vehicles, loud machines or other ultrasonic sources.
- Under certain weather conditions, e.g., high moisture, wet conditions, snowfall, cold, extreme heat, or strong wind.
- With tow bars and trailer hitches of other vehicles.
- With thin or wedge-shaped objects.
- With moving objects.
- For elevated, protruding objects, e.g., wall ledges.
- With objects with corners, edges, and smooth surfaces.
- In the case objects with fine surfaces or structures, e.g., wire mesh fences.
- For objects with porous surfaces.
- With small and low objects, e.g., boxes.
- Low objects already displayed, for instance curbs, can be outside of the detection ranges of the sensors.
- With soft obstacles or obstacles covered in foam material.



- With plants and bushes.
- In automatic car washes.
- For bumps, e.g., speed bumps.
- If there are large amounts of exhaust gas.
- Cargo that extends beyond the perimeter of the vehicle is not taken into account by the ultrasonic sensors.

If applicable, a Check Control message will be displayed when the system limits are reached.

Operating state of the vehicle

Vehicle features and options

This chapter describes model-specific equipment, systems, and functions that are currently available, or may become available in the future, even if they are not present in the vehicle.

Additional information:

Vehicle equipment, refer to page 8.

General information

Depending on the situation, the vehicle is in one of the three states:

- Idle state.
- Standby state.
- Drive-ready state.

Overview

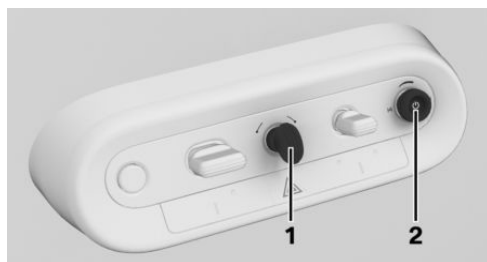

- 1 Start/Stop switch
- 2 Volume button, setting idle state

Idle state

Principle

The vehicle switches off when set to idle state.

The vehicle is in idle state prior to opening from the outside and after exiting and locking.

Safety information

Warning

An unsecured vehicle can begin to move and possibly roll away. There is a risk of accident, injury, or property damage. Before leaving the vehicle, secure the vehicle against rolling away.

In order to ensure that the vehicle is secured against rolling away, follow the following:

- Set the parking brake.
- On uphill grades or on downhill slopes, turn the front wheels in the direction of the curb.
- On uphill grades or on downhill slopes, also secure the vehicle, for instance with a wheel chock.

Warning

Unattended children or animals in the vehicle can cause the vehicle to move and endanger themselves and traffic, for example, due to the following actions:

- Establishing standby.
- Releasing the parking brake.
- Opening and closing the doors or windows.



- Engaging selector lever position N.
- Using vehicle equipment.

There is a risk of accident, injury, or property damage. Do not leave children or animals unattended in the vehicle. Take the vehicle key with you when exiting and lock the vehicle.

Establishing the sleep mode automatically

The sleep mode is established automatically such as in the following situations:

- After several minutes, if no operation takes place on the vehicle.
- If the charge state of the vehicle battery is low.
- Depending on settings configured via Interaction Unit: One or both front doors will open when exiting the vehicle after a drive.

In some situations, the idle state is not set automatically, for instance during a phone call or when the low-beam headlights are switched on.

Establishing idle state when opening the front doors

After a trip, the sleep mode can be established by opening the front doors. For this purpose, all passengers must exit the vehicle.

To activate/deactivate this function, go through the menu as follows: Apps menu / "Vehicle" / "Doors and windows" / "Lock/unlock" / "Turn off after opening door".

Establishing the sleep mode manually

The vehicle can be set to idle state manually at the end of the drive.



To switch to idle state, press and hold the volume button on the switch cluster until the OFF indicator on the Interaction Unit disappears.

Deep sleep mode

Principle

Deep sleep mode is activated to prevent the vehicle battery from discharging when the vehicle is stationary for several weeks.

In deep sleep mode, the vehicle functions are limited to the essentials.

General information

When the vehicle is shut down for longer than three months, some special measures are necessary. For more information, contact an authorized service center or another qualified service center or repair shop.

Activating deep sleep mode

1. Go through the menu as follows: Apps menu / "Vehicle" / "System settings" / "Deep sleep mode".
2. Select the desired setting.

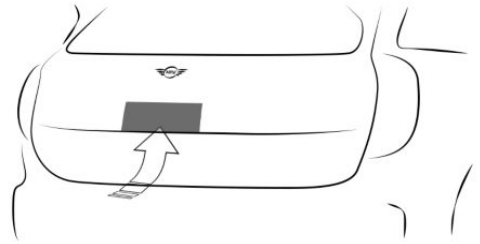

To access the vehicle while it is in deep sleep mode, press the Open button in the cargo area. Deep sleep mode remains on in this case.



Deactivating deep sleep mode

- Turn off the function using the Interaction Unit.
- Driving with the vehicle.

Standby state

Principle

When standby state is switched on, most functions can be used while the vehicle is stationary. Desired settings can be adjusted. The vehicle is in the standby state after the front doors are opened from the outside.

Manually setting to standby

General information

Standby can be switched back on after the vehicle is automatically set to idle state.

Using the Start/Stop switch



Turn the Start/Stop button on the switch cluster. The Interaction Unit illuminates.

Interaction Unit view



OFF is displayed on the Interaction Unit. The drivetrain is switched off and standby state switched on.

Drive-ready state

Principle

Turning on drive-ready state corresponds to starting the engine.

General information

Some vehicle functions can only be used with the drive-ready state switched on.

Safety information

DANGER

If the exhaust pipe is blocked or ventilation is insufficient, harmful exhaust gases can penetrate the vehicle. The exhaust gases contain pollutants which are colorless and odorless. In enclosed areas, exhaust gases can also accumulate outside of the vehicle. There is a danger to life. Keep the exhaust pipe free and ensure sufficient ventilation.

Warning

An unsecured vehicle can begin to move and possibly roll away. There is a risk of accident, injury, or property damage. Before leaving the vehicle, secure the vehicle against rolling away.

In order to ensure that the vehicle is secured against rolling away, follow the following:

- Set the parking brake.
- On uphill grades or on downhill slopes, turn the front wheels in the direction of the curb.
- On uphill grades or on downhill slopes, also secure the vehicle, for instance with a wheel chock.

NOTICE

Repeatedly attempting to start the engine or repeatedly starting the vehicle in rapid succession can cause the starter to overheat. This also results in unburned or inadequately burned fuel, and can cause the catalytic converter to overheat. There is



a risk of damage to property. Avoid repeated starting of the vehicle, particularly repeated starting in rapid succession.

Turning on the drive-ready state

General information



Drive-ready state is turned on/off using the Start/Stop button on the switch cluster.

Turning on the drive-ready state

1. Depress the brake pedal.



2. Turn the Start/Stop button on the switch cluster.

The ignition is activated automatically for a brief time and is stopped as soon as the engine starts.

Most indicator lights and warning lights on the Interaction Unit illuminate for different lengths of time.

Gasoline engine

Depending on the motorization, the full drive power may not be available for approximately 30 seconds after starting the engine. In this case, the vehicle will not accelerate as usual.

Interaction Unit view

When drive-ready state is on, the Interaction Unit indicates this by displaying necessary driving information or READY, depending on vehicle equipment.

Turning off drive-ready state

After stopping the vehicle:

1. Apply the brake and engage selector lever position P.
2. Engage the parking brake.
3. Turn the Start/Stop switch on the center console.

The READY indicator goes out and a signal tone sounds.

The drive-ready state is switched off automatically if the driver's seat belt is not buckled when the driver's door is opened.

Display and operating concept

Vehicle features and options

This chapter describes model-specific equipment, systems, and functions that are currently available, or may become available in the future, even if they are not present in the vehicle.

Additional information:

Vehicle equipment, refer to page 8.

MINI Interaction Unit

Principle

The Interaction Unit consists of a central round display with functions that can be operated by touch.

Depending on vehicle equipment, functions can also be operated via the MINI Intelligent Personal Assistant or the operating elements in the vehicle.

The Interaction Unit turns on automatically when it is needed to operate a certain function or when the vehicle is unlocked.

The Interaction Unit's main menu is divided into different areas, e.g., menu bar, status information, and widgets.

Various settings can be configured, e.g., the brightness of the Interaction Unit.

Safety information

Warning

Operating the integrated information systems and communication devices while driving can distract from surrounding traffic. It is possible to lose control of the vehicle. There is a risk of accident, injury, or

property damage. Only use the systems or devices when the traffic situation allows. As warranted, stop and use the systems and devices while the vehicle is stationary.

Warning

When driving, loose items or devices connected to the vehicle with a cable, i.e., mobile phones, may be thrown around the vehicle, e.g., in the event of an accident or when braking or performing evasive maneuvers. There is a risk of injury and risk of damage to property. Secure loose objects or devices that are connected to the vehicle via a cable.

Warning

Objects in the area in front of a display can slip and damage the display. There is a risk of injury or risk of damage to property. Do not place objects in the area in front of a display.

Overview

Position in the vehicle

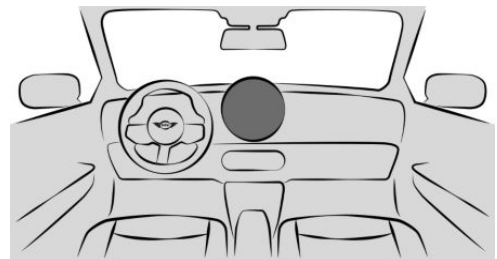

The Interaction Unit is located on the instrument panel above the center console.



Display

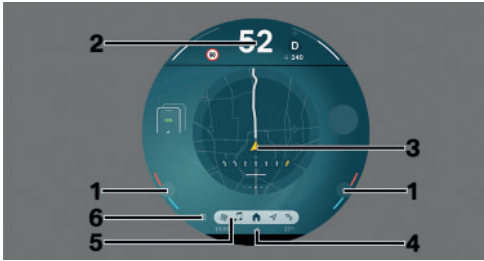

- 1 Temperature setting
- 2 Driving information **48**
- 3 Widgets
- 4 Status information
Quick access
- 5 Menu bar
- 6 Saved messages
Check Control messages **133**

Turning the Interaction Unit on/off

The Interaction Unit turns on automatically when the vehicle is unlocked or when it is needed to operate another function.

The Interaction Unit turns off automatically in certain situations, e.g., if the vehicle is not operated for several minutes.

Menu bar

Main menu

The main menu can be opened from any menu.

Climate menu

The Climate menu provides access to all climate control functions.

Media menu

The Media menu provides entertainment system functions, e.g., radio stations, and can also be used to pair external devices.

This icon indicates the active media source.

Apps menu

The Apps menu provides access to all apps and vehicle functions. You can use a filter to make it easier to find a specific app. The last selected filter is stored. To display the desired app, change the filter as necessary.

Navigation menu

The Navigation menu provides navigation system functions, e.g., route guidance and traffic information.

If route guidance is activated, the estimated arrival time is displayed on the menu bar.

Apple CarPlay®

The Apple CarPlay menu is displayed in the main menu depending on national-market version and connected function. Apple CarPlay makes it possible to securely use select functions of a compatible Apple iPhone via the Interaction Unit.

Android Auto®

The Android Auto menu is displayed in the main menu, depending on national-market version and associated function. Android Auto makes it possible to securely use select functions of a compatible Android smartphone via the Interaction Unit.

Communication menu

The Communication menu provides calling and messaging functions and can also be used to pair and manage mobile devices, e.g., smartphones.

Widgets

Widgets show real-time information and dynamic content such as the navigation map. Widgets also serve as buttons and allow





you to jump to the respective menu or most important functions.

Status information





General information

Status information is displayed in the form of icons on the bottom middle edge of the Interaction Unit. Depending on the equipment and national-market version, different icons are available.



Telephone status information

Icon	Meaning
	Active call.
	Microphone turned on.
	Microphone turned off.
	SIM card missing.
	Wireless charging active.

Entertainment status information

Icon	Meaning
	USB audio.
	Bluetooth audio.
	Time shift.
	Satellite radio is switched on.



Status information messages

Icon	Meaning
	Notifications.
	Check Control message.
	Do not disturb.

Additional information:

Owner's Manual for Navigation, Entertainment, and Communication, refer to page 6.

Other status information

Icon	Meaning
	Sound output deactivated.
	Activation word active.
	MINI ID or driver profile.
—	Go to quick access.

Quick access

Certain functions and individual shortcuts can be opened via quick access.





Function	Operation
Show quick link.	On the Interaction Unit, swipe from bottom to top. — Tap the icon on the status bar.
Hide quick link.	On the Interaction Unit, swipe from top to bottom.

Input and display

Entering letters and numbers

Letters and numbers can be selected when inputting destinations, for example.

Letters and numbers can be entered using the Interaction Unit or spoken commands.

Icon	Function
 	Change between capital and lower-case letters.
	Enter a blank space.
EN	Switching between languages.
	Use voice control.
OK	Confirm entry.

Icon	Function
	Shift the input area to the left or right.
	Tap icon: delete a letter or a number.
	Press and hold the icon: delete all letters or numbers.

Entry comparison

When entering data from a database such as contacts, the selection is gradually narrowed down for each character entered, with characters being added as necessary.

Activating/deactivating the functions

Some menu items are preceded by an icon. Selecting the menu item enables or disables the function.

Icon	Meaning
	Function is activated.
	Function is deactivated.
	Functions can be activated or deactivated using the button on the Interaction Unit. If the button is highlighted in color, the function is activated.

Shortcuts

Principle

Shortcuts provide quick access to functions such as those that are frequently used. Shortcuts can be created as necessary.

Go to the shortcuts as follows:



- Using the buttons on the steering wheel.
- Via quick access on the Interaction Unit.

The following functions, for example, are defined as shortcuts:

- Radio stations.
- Navigation destinations.
- Phone numbers.
- Jumps to menus.

Saving shortcuts

Shortcuts can only be created with an active MINI ID or driver profile.

1. Press and hold the desired function.
2. "Add to shortcuts"

Shortcuts can also be saved directly via quick access.

Selecting shortcuts

1. To select a shortcut, swipe up from the middle of the Interaction Unit, from bottom to top.
2. Select the desired shortcut.

The function will work immediately. This means for instance that the connection is established when a phone number is selected.

Sorting shortcuts

1. To select a shortcut, swipe up from the middle of the Interaction Unit, from bottom to top.
2. Press and hold the desired shortcut and move it to the desired position.

Deleting shortcuts

1. To select a shortcut, swipe up from the middle of the Interaction Unit, from bottom to top.
2. Tap the three dots for the desired shortcut.
3.  Tap the icon for deleting the desired shortcut.

Operation

Sorting apps

The order of apps can be adjusted in the Apps menu.

1. Open the Apps menu.
2. Press and hold the desired app icon and move it to the desired position.

Calling up the context menu

Depending on the menu item, a context menu with additional options can be displayed.

To bring up the Context menu, press and hold the desired menu item.

The menu consists of various areas, for instance:

- "General help": The Integrated Owner's Manual opens.
- "Add to shortcuts": The menu item is defined as a shortcut.

Using the map

The navigation map can be moved on the Interaction Unit.

Function	Operation
Move map.	Swipe in the appropriate direction.
Enlarge/shrink map.	Drag in or out with the fingers.
Display menu.	Tap once.

Using alphabetical lists

Contacts are listed in alphabetical order.

To navigate to a desired initial letter in a list of more than 30 entries, tap the letter on the letter bar and scroll up or down.

Favorites are displayed at the top of the list. Entries with numbers are displayed at the end of the list.

Limiting the information shown on the Interaction Unit

The information shown on the Interaction Unit can be limited to relevant trip information.

To limit the information shown on the Interaction Unit, go through the menu as follows: Apps menu: Apps menu / "Vehicle" / "Displays" / "Interaction Unit" / "Essential info only".

Tap the Interaction Unit to have more information displayed.

Setting the brightness

1. To adjust the brightness of the Interaction Unit, go through the menu as follows: Apps menu / "Vehicle" / "Displays" / "Interaction Unit" / "Brightness at night".
2. Select the desired setting.

Depending on the light conditions, the brightness control may not be clearly visible.



Enabling/disabling audible feedback

The Interaction Unit's audio confirmation can be activated or deactivated.

1. Go to the Media menu.



2. Select the settings icon.



3. "Sound"

4. "Touchscreen"

5. Select the desired setting.

System limits

When the Interaction Unit is subjected to very high temperatures, e.g., due to intense sunlight, the brightness may be reduced until the Interaction Unit switches off completely. The normal functions are restored once the temperature decreases, e.g., with shade or the air conditioning system.

Driving information

Principle

The driving information comprises various digital displays, e.g., speedometer, time, range, and temperature, as well as indicator lights and warning lights.

Safety information

Warning

If the driving information displays on the instrument cluster fail, e.g., the speedometer, do not use the vehicle. There is a risk of accident, injury, or property damage. Immediately park the vehicle in a safe manner. Turning drive-ready state off and on again may correct the malfunction, allowing you to continue driving. If the malfunction cannot be corrected, have the

vehicle checked by an authorized service center or another qualified service center or repair shop.

Overview

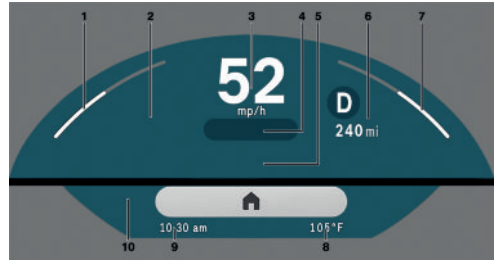

- 1 Power gauge 140
Tachometer 140
Efficiency trainer 282
- 2 Speed Limit Info 197
Speed Limit Assistant 214
- 3 Operating state of vehicle 39
Speedometer
Speedometer 139
- 4 Driver assistance systems 197
- 5 Widgets, detailed information
- 6 Selector lever position 118
Trip data 131
Gear shift indicator 142
Range 143
- 7 Fuel gauge 144
- 8 Outside temperature 145
- 9 Time 146
- 10 Check Control 133

The layout is adapted to the respective drive mode.

Some views may look different than they are depicted in the Owner's Manual.

Additional information:

Indicator lights and warning lights, refer to page 134.

Showing detailed information

The Interaction Unit can provide additional specifics for some driving information.

Select the detailed information by tapping the desired area, e.g., tap the speedometer or Speed Limit Info display.

To show selection lists, e.g., current entertainment source, press the desired button on the right side of the steering wheel.

Additional information:

- Selection lists, refer to page 141
- Assisted View, refer to page 145.
- Displays, trip data, refer to page 131.
- Speedometer, refer to page 139.

Direct access buttons



Principle

There are buttons for jumping directly to certain functions in the vehicle. These buttons can be used to bring up the respective menu directly on the Interaction Unit. Then continue operation on the Interaction Unit.

Overview



The direct jump buttons are located on the switch cluster, turn signal lever, and headliner.

Button	Function
	Go to the Drive Settings menu on the switch cluster.
	Go to the Exterior Lighting menu on the turn signal lever.
	Go to the Interior Lighting menu on the headliner.

MINI Intelligent Personal Assistant

Principle

The MINI Intelligent Personal Assistant is a personal assistant that operates various vehicle functions by means of natural spoken commands.

The Personal Assistant provides proactive suggestions to make it easier to operate the vehicle. The Personal Assistant is available depending on national-market version. The function scope and detection may vary depending on national-market version.

You can use supported voice assistants from third parties in your vehicle after pairing your smartphone.

You can configure various settings such as the suggestions from the Personal Assistant.

The system includes special microphones on the driver side and the front passenger side.

Using the voice activation system

>...<: In the Owner's Manual, commands that can be spoken are indicated by brackets.

When saying commands, note the following:



- Say the commands at a normal volume. Speaking directly into the microphone does not improve voice recognition.
- Say the commands fluently and with normal volume, emphasis, and speed.

Functional requirements

The following functional requirements apply for the Personal Assistant:

- To set a system language via the Interaction Unit, this language must be supported by the Personal Assistant.
- Download the corresponding language package before using the Personal Assistant for the first time.
- Commands must always be spoken in the selected system language.

For the full range of functions, the following functions should be activated or purchased:

- Online speech processing is enabled.
- All settings under Data privacy are enabled.
- The activation word is enabled.
- Suggestions are activated.
- A MINI ID or driver profile is activated.
- Corresponding MINI Connected Services are purchased in the MINI Connected Store.

Additional information:

- Setting the system language, refer to page 51.
- Online speech processing, refer to page 52.
- Data protection, refer to page 59.
- Activation word, refer to page 50.
- Get suggestions, refer to page 52.

Activating the voice control system

General information

You can activate voice control as follows:



- Briefly press the microphone button on the steering wheel.
- Say the activation word.

Microphone button on steering wheel



1. To activate voice control with the microphone button, briefly press the voice control button on the steering wheel.
The microphone on the driver's side is active.
2. Say the desired command.

Activation word

Principle

>Hello<: Saying the activation word starts the Personal Assistant. The microphones on the driver's or front passenger's side are active with the following voice control, depending on where the activation word was spoken.

Then say the command. The activation word and the command can be spoken without pause in one sentence.

Enabling/disabling the activation word

The activation word can be enabled and disabled.

To activate/deactivate the activation word, go through the menu as follows: Apps menu / "All" / "Personal Assistant" / "Settings" / "General" / "Activation with voice control".

Activation word from third-party providers

Depending on the national-market version, some third-party providers provide digital voice assistants such as Siri or Amazon Alexa.

To use Siri, the smartphone must be connected via Apple CarPlay.

Supported voice assistants can be used in the vehicle after you have connected your smartphone.

The activation word for voice assistants from affiliated third-party providers can be used in addition to the activation word from MINI.

1. Go through the menu as follows: Apps menu / "Vehicle" / "System settings" / "Voice control" / "Other assistants".
2. Select the desired setting.

Canceling voice control

You can cancel voice control as follows:

-  Press the microphone button on the steering wheel again.
- Say the following command: ›Cancel‹

Possible voice commands

Principle

Voice commands can be used to give instructions or ask questions, with the Personal Assistant providing assistance.

It is possible, for example, to call contacts, navigate to an address, change settings, or control vehicle functions, e.g., air conditioning, by voice command.

In addition, voice commands can be used to bring up the most important features on the Interaction Unit, e.g., menu items or lists.

Help for voice control

You can say the following commands to get help with voice control:

- ›Voice commands‹: Possible example commands are announced.
- ›General information on voice control‹: Information on how voice control operates is announced.
- ›Help‹: Tips and example commands for voice control are announced.

Sample commands

- ›Call John Smith‹
- ›Drive me to JFK airport‹
- ›Increase volume‹ or ›Decrease volume‹
- ›Activate the climate control‹
- ›What is my remaining range‹

Menu items

The Personal Assistant can open menu items directly. Say the menu items as they are shown on the Interaction Unit. You do not have to follow the order of the menu items when speaking them out loud.

1. Activate voice control.
2. ›Media‹
3. ›Presets‹
Saved stations are displayed on the Interaction Unit.

Settings

Setting the system language

You must set a system language that is supported by the Personal Assistant. A language package can be downloaded.

1. To adjust the system language, go through the menu as follows: Apps menu / "Vehicle" / "System settings" / "Language".
2. Select the desired setting.



Managing language packages

1. To manage language packages, go through the menu as follows: Apps menu / "All" / "Personal Assistant" / "Settings" / "Language".
2. Select the desired setting.

Suggestions

The Personal Assistant provides helpful, individual suggestions. Suggestions can be enabled or disabled. Suggestions can be customized, e.g., which categories suggestions are based on or whether to emit a signal tone.

1. To configure the settings, go through the menu as follows: Apps menu / "All" / "Personal Assistant" / "Settings" / "Suggestions".
2. Select the desired setting.

Online speech processing

Online speech processing improves the quality of the speech recognition and search results for points of interest. To use the functions, data is transmitted to a service provider via an encrypted connection and stored locally there. Online speech processing is not available in all languages.

To configure the settings, go through the menu as follows: Apps menu / "All" / "Personal Assistant" / "Settings" / "General" / "Online speech processing".

Configuring the visualization

How the Personal Assistant is visualized can be set.

1. To configure the visualization, go through the menu as follows: Apps menu / "All" / "Personal Assistant" / "Settings" / "General" / "Visualization".
2. Select the desired setting.

Voice control from third-party providers

Depending on vehicle equipment, third-party voice control can be activated by pressing and holding the microphone button on the steering wheel.

1. To configure the settings, go through the menu as follows: Apps menu / "Vehicle" / "System settings" / "Voice control".
2. Select the desired setting.

Adjusting the volume

Turn the volume button during the voice guidance until the desired volume is set. The volume remains constant even if the volume of other audio sources is changed.

Using the voice activation of the smartphone

Depending on the device, a smartphone connected to the vehicle can be used via voice control.

The device must be connected via Apple CarPlay or Android Auto.

1.  Press and hold the voice control button on the steering wheel for approx. 3 seconds.

The voice activation of the smartphone is activated.

If the activation was successful, a confirmation appears on the Interaction Unit.

2.  Press the voice control button on the steering wheel to cancel the smartphone voice control.

Amazon Alexa Car Integration

Principle

Amazon Alexa Car Integration is available depending on vehicle equipment and national-market version. Alexa is a digital assistant from Amazon. With Amazon Alexa Car Integration, Alexa can be used in the vehicle. For safety reasons, the use of some Alexa functions may be restricted while driving your vehicle.

Functional requirements

- A MINI ID or driver profile is activated.
- An active Amazon account must exist.

Activating Amazon Alexa Car Integration

Amazon Alexa Car Integration is activated in the vehicle.

Follow the instructions from the Amazon Alexa app to set it up in the vehicle.

1. To activate Amazon Alexa Car Integration, go through the menu as follows:
Apps menu / "All" / "Alexa".
2. Select the desired setting.

After setting it up, use Amazon Alexa in the vehicle as follows:

Say the activation word "Alexa" and the desired command.

Information about the active function is shown on the Interaction Unit.

System limits

- The Personal Assistant provides information about vehicle functions that may not be installed in the vehicle. This also applies to safety functions and systems.
- Certain noises can be detected and may lead to problems. Keep the doors and windows closed.

- Noises from the front passenger or occupants can impair the system. Avoid making other noise in the vehicle while speaking.
- Major language dialects can cause problems with the speech recognition feature.
- A poor data connection influences the response time of the Personal Assistant and the Search.

Connecting mobile devices to the vehicle

Principle

Various connection types are available for using mobile devices in the vehicle. The connection type to select depends on the mobile device and the desired function.

General information

Detailed information on the functions and connection types can be found in the following media in the Owner's Manual under the specified keyword:

- Integrated Owner's Manual in the vehicle.
- Printed Owner's Manual for navigation, communication and entertainment.

The following information sources can also be used:

- Driver's Guide app.
- Driver's Guide Web.

Safety information







Warning

Operating the integrated information systems and communication devices while driving can distract from surrounding traffic. It is possible to lose control of the vehicle. There is a risk of accident, injury, or property damage. Only use the systems or devices when the traffic situation allows.

As warranted, stop and use the systems and devices while the vehicle is stationary.

Overview

The following overview shows possible functions and the suitable connection types for them. The functions available depend on the vehicle equipment and connected mobile device.

Function	Connection type	Icon on Interaction Unit
Making calls via the hands-free system. Operate telephone functions via the Interaction Unit. Keyword: calling via Bluetooth.	Bluetooth. Keyword: Bluetooth connection.	
Playing music from a mobile device. Keyword: audio.	Bluetooth audio. Keyword: Bluetooth connection.	 
Play music from a USB stick. Keyword: audio.	USB. Keyword: USB connection. USB port, refer to page 257.	
Data exchange between mobile device and vehicle.	Wi-Fi. Keyword: vehicle WLAN.	
Operate Apple CarPlay using the Interaction Unit and by voice command. Keyword: Apple CarPlay.	Bluetooth and Wi-Fi. Keyword: Bluetooth connection and vehicle Wi-Fi.	
Operate Android Auto using the Interaction Unit and by voice command. Keyword: Android Auto.	Bluetooth and Wi-Fi. Keyword: Bluetooth connection and vehicle Wi-Fi.	
Charge USB device. Keyword: USB connection. USB port, refer to page 257.	USB. Keyword: USB connection. USB port, refer to page 257.	

MINI Remote Software Upgrade

Vehicle features and options

This chapter describes model-specific equipment, systems, and functions that are currently available, or may become available in the future, even if they are not present in the vehicle.

Additional information:

Vehicle equipment, refer to page 8.

MINI Remote Software Upgrade

Principle

Remote Software Upgrade can be used to update the entire software of the vehicle. This makes new functions, functional enhancements or quality improvements available.

General information

MINI recommends performing the Remote Software Upgrade as soon as it becomes available.

Safety information

Warning

Unattended children or animals in the vehicle can cause the vehicle to move and endanger themselves and traffic, for example, due to the following actions:

- Establishing standby.
- Releasing the parking brake.
- Opening and closing the doors or windows.

- Engaging selector lever position N.
- Using vehicle equipment.

There is a risk of accident, injury, or property damage. Do not leave children or animals unattended in the vehicle. Take the vehicle key with you when exiting and lock the vehicle.

Functional requirements

The following requirements apply for Remote Software Upgrade:

- Active ConnectedDrive contract.
- The integrated SIM card in the vehicle has been activated.
- The vehicle has mobile network reception.
- Consent to send corresponding data has been granted in the MINI Remote Software Upgrade settings.

Settings

To bring up the Remote Software Upgrade settings, go through the menu as follows: Apps menu / "All" / "System settings" / "Remote Software Upgrade" / "Settings".

Additional information:

Data protection, refer to page 59.

Search for an upgrade

Functional requirement

Standby must be turned on to search for a Remote Software Upgrade.

Automatic search

The vehicle checks regularly for Remote Software Upgrades in the background.



Manual search

1. To search manually for a Remote Software Upgrade, go through the menu as follows: Apps menu / "All" / "System settings" / "Remote Software Upgrade" / "Search for upgrade".
2. Follow the instructions on the Interaction Unit.

Downloading an upgrade

Automatic download

If available, the data for a Remote Software Upgrade is automatically downloaded to the vehicle. No download consent is required.

Via the MINI app

If a Remote Software Upgrade is available, information about the new software version is given in the MINI app.

The data for the upgrade can then be downloaded to a mobile device, for instance via an existing WLAN connection.

Data can then be sent from the mobile device to the vehicle.

This transmission method accelerates the download of the data, for instance in areas with limited mobile network availability.

1. On the MINI app, download the upgrade to the smartphone.
2. Follow the instructions in the MINI app.
3. Connect your smartphone to the vehicle via Bluetooth audio and Wi-Fi.

Data for the upgrade is sent from the mobile device to the vehicle both while driving and when stopped. Depending on the size of the upgrade, it may be necessary to drive your vehicle to complete the data transfer.

4. Follow the instructions on the Interaction Unit.

Additional information:

Connecting mobile devices to the vehicle, see Owner's Manual for Navigation, Entertainment, Communication.

Information about the version

General information

The information about the version contains a description of the updates included in the Remote Software Upgrade. Information on the version can be shown on the Interaction Unit while downloading and after the installation is complete.

This information is also available in the ConnectedDrive customer portal.

Displaying information

Information on the Remote Software Upgrade can be displayed in the vehicle using the Interaction Unit or viewed online in the ConnectedDrive customer portal:

1. To display information in the vehicle, go through the menu as follows: Apps menu / "All" / "System settings" / "Remote Software Upgrade".
2.
 - Display currently installed version: "Installed version:"
 - Display new available version: "Version info"
3. Follow the instructions on the Interaction Unit.

To view the information in the ConnectedDrive customer portal, visit the website:

www.mini.com/connected.

Installing the upgrade

What to know before upgrading

Before installing an upgrade, note the following:

- Installation of the Remote Software Upgrade may result in the deletion of

- software changes, e.g., performance increases not made by the manufacturer of the vehicle.
- The installation may be interrupted if there are modifications to the vehicle's electrical system, e.g., to control units, which were not made by the vehicle manufacturer.
 - The installation does not occur until the consent was given.
 - The installation may take around 20 to 30 minutes.
 - The installation cannot be terminated.
 - The vehicle cannot be used during the installation.
 - The vehicle can be exited during the installation.

Prerequisites for the installation

The following requirements apply when installing Remote Software Upgrades:

- Sufficiently charged battery.
- The outside temperature is above 14 °F/-10 °C.
- The vehicle is parked in a horizontal position.
- The hazard warning system is turned off.
- The selector lever position P is engaged.
- The engine is turned off and sufficiently cooled down.

Where applicable, note additional requirements given on the Interaction Unit.

If the requirements are not met, e.g., sufficiently charged battery, the upgrade will not be offered for installation.

Pay attention to an offer for installation, e.g., after longer trips.

Preparing the vehicle

- Park the vehicle safely away from the public road.
- Make sure that the vehicle has mobile network reception so that a fault message can be sent to the vehicle manufacturer, e.g., if the installation is canceled.
- Close the window.
- Close the glass sunroof.
- Close the trunk.
- Remove devices that consume power, e.g., a mobile phone.
- The vehicle key must be located in the vehicle for the consent for installation.
- Turn off the exterior lighting.
- Remove any devices connected to the diagnostic socket.

Install the upgrade immediately

The upgrade can be installed immediately if all prerequisites have been met.

1. Go through the menu as follows: Apps menu / "All" / "System settings" / "Remote Software Upgrade" / "Start installation".
2. Follow the instructions on the Interaction Unit.

Installing an upgrade with the timer

Once the drive is complete, the timer can be used to automatically install the upgrade at a preset time, e.g., during the night. It may be helpful to install the upgrade at a later time so that all functional requirements can be met, e.g., to allow the engine to cool sufficiently.

1. Go through the menu as follows: Apps menu / "All" / "System settings" / "Remote Software Upgrade".
2. Select the desired settings.

The installation starts automatically when:



- All prerequisites for the installation have been established correctly.
- All prerequisites continue to be met at the time of installation.

The timer is turned off when the drive-ready state is turned on.

Installing via the MINI app

Once all preparations are done and all requirements are met, the MINI app can also be used to start the upgrade installation when the vehicle is parked. The upgrade installation can be started remotely.

Follow the instructions on the MINI app.

Functional limitations

During the upgrade, the majority of functions is temporarily unavailable, for instance:

- Hazard warning flashers.
- Central locking system and Comfort Access, as applicable.
- Parking light.
- Horn.
- Alarm system.
- Emergency call.
- Power windows.
- Glass sunroof.
- Locking the tank flap.
- Operating the tailgate or trunk lid.
- Exit warning if needed.

In vehicles with frameless doors, the window may no longer close completely.

The driver's door can be locked and unlocked from the outside using the integrated key.

After successful upgrade

The vehicle can be used again immediately.

Purchased services, e.g., Advanced Real Time Traffic Information or Remote Services, are automatically reactivated the next time the vehicle is driven.

If the vehicle has been stationary for some time, it may be necessary to recharge the vehicle battery by going for a long drive.

Malfunction

If the Remote Software Upgrade malfunctions, follow the instructions on the Interaction Unit or MINI app.

If the malfunction cannot be corrected, contact an authorized service center or another qualified service center or repair shop.

Validity of the Owner's Manual

Production of the vehicle

At the time of production at the plant, the printed Owner's Manual is the most current resource.

After a software update in the vehicle

After a vehicle software update, for example, via Remote Software Upgrade, the Integrated Owner's Manual for the vehicle will contain the latest information, depending on the national-market version.

Before setting off, make sure that the Integrated Owner's Manual is available and up-to-date.

Personal settings

Vehicle features and options

This chapter describes model-specific equipment, systems, and functions that are currently available, or may become available in the future, even if they are not present in the vehicle.

Additional information:

Vehicle equipment, refer to page 8.

Data protection

Data transfer

Principle

The vehicle offers various services that must send data to MINI or a service provider in order to be used.

The data transfer can be deactivated for some services. When data transfer is deactivated, the respective service cannot be used.

Settings

The data transfer can be configured in different stages or individually for separate services.

1. To configure the settings, go through the menu as follows: Apps menu / "All" / "Data privacy".
2. Select the desired setting.

Personal data in the vehicle

Principle

Depending on use, your vehicle stores personal data such as saved radio stations. This

personal data can be permanently deleted using the Interaction Unit.

General information

Depending on vehicle equipment, the following data is deleted, for example:

- MINI IDs or driver profiles.
- Stored radio stations.
- Stored shortcuts.
- Navigation, for instance stored destinations.
- Phone book.
- Online data, e.g., favorites, cookies.
- Office data, for instance voice memos.
- Login accounts.
- Digital key.

Altogether, the deletion of the data can take up to 15 minutes. In addition, the vehicle is removed from the MINI app and MINI Connected customer portal so that remote functions can no longer be used.

Functional requirements

The following functional requirements apply when deleting personal data in the vehicle:

- Data can only be deleted while the vehicle is stationary.
- The vehicle key must be in the vehicle.

Deleting personal data in the vehicle

The personal data in the vehicle will be deleted when the vehicle is reset to the factory settings.

Additional information:

Resetting vehicle data, refer to page 60.



Reset vehicle data

All individual settings can be reset to the factory settings when the drive-ready state is switched off. Individual settings can only be deleted while the vehicle is stationary. The vehicle key must be in the vehicle.

Go through the menu as follows: Apps menu / "Vehicle" / "System settings" / "Reset vehicle data" / "Reset".

If settings synchronization has been enabled for a MINI ID in the vehicle, personal settings are kept in the MINI Cloud.

MINI ID

Principle

In MINI Connected countries, the MINI ID is the personal login for all relevant offers from the MINI brand. The MINI ID can be used to save personal vehicle settings to a profile as well as to apply these settings.

Seven MINI IDs can be saved to the vehicle. If a vehicle is used by several people, each person can use their own MINI ID in the vehicle. Additional profiles can be used to operate the vehicle without a MINI ID, e.g., the guest profile.

The MINI ID must be registered once. A MINI ID can be registered via the MINI app, on the MINI portal, or at an authorized service center.

Automatic driver recognition can activate a MINI ID as soon as the vehicle is unlocked. To do so, a vehicle key or digital key must be linked to the MINI ID.

Many saved settings can be synchronized with the MINI Cloud. If the same MINI ID is used to log into another vehicle, these settings can be used there.

Functional requirements

The following functional requirements apply for the MINI ID:

- The vehicle must be stationary to create, change, delete, or edit a MINI ID.
- The vehicle must have mobile network reception in order to use a MINI ID to login into the vehicle and synchronize with the MINI Cloud.

Welcome window

The welcome window appears on the Interaction Unit after the vehicle is unlocked. The type of welcome depends on the following requirements:

- No MINI ID is saved to vehicle:
The welcome is neutral. These profiles are provided to use the vehicle without a MINI ID. A new MINI ID can be added.
- The vehicle key or digital key has not been assigned to a MINI ID:
The welcome is neutral. Saved profiles are shown for selection. A new MINI ID can be added.
- A MINI ID has been assigned to the vehicle key or digital key:
The welcome is personalized, the stored settings are activated. Available profiles are shown for selection. A new MINI ID can be added.

Adding a MINI ID

1.  To add a MINI ID, tap the MINI ID icon or profile image on the status bar.
2.
 - The guest profile is active:
"Guest" / "Add profile".
 - The driver profile is active:
"Log in with MINI ID".
3. Scan the displayed QR code with your smartphone.

4. Observe the instructions on your smartphone.

The MINI ID is automatically transferred to the vehicle if the MINI app is installed on the smartphone where the MINI ID is saved.

If no MINI ID is currently available, a new MINI ID can be registered.

5. Change additional settings as necessary, e.g., automatic driver recognition.

The vehicle is added to the user's MINI app. Alternatively, the authorized service center can register the MINI ID and add it to the vehicle.

Confirming a MINI ID

If the MINI ID was registered by the authorized service center and added to the vehicle, the MINI ID must be confirmed on the Interaction Unit in the respective vehicle.

1. Select the MINI ID.
2. Scan the QR code shown.
3. Follow the instructions on your smartphone.

MINI app

If a MINI ID has been added to the vehicle, the vehicle is automatically added to the MINI app. This means that MINI app functions can be used for this vehicle. To do so, the MINI app must be used with the same MINI ID.

Alternatively, an authorized service center can add a vehicle to the MINI app. In this case, the MINI ID must then be confirmed on the Interaction Unit in the corresponding vehicle.

In rare cases, the use of MINI app functions for this vehicle may be restricted. More information is given on the Interaction Unit.

Primary user

The primary user is the person who first adds their MINI ID to the vehicle and the vehicle to their MINI app. Alternatively, the primary user can be specified by an authorized service center.

The primary user has access to the following settings, for example:

- Removing the MINI ID saved to the vehicle.
- Transferring the primary user role to another MINI ID.
- Configuring vehicle-wide data protection settings.
- Creating the main digital key.

Additional information:

MINI Digital Key, refer to page 80.

Personalized settings

Automatic driver recognition

Principle

Automatic driver recognition can activate a MINI ID as soon as the vehicle is unlocked. To do so, a vehicle key or digital key must be assigned to the MINI ID. The MINI ID can be changed after unlocking.

If driver recognition has been configured, automatic activation of the MINI ID is triggered by the following:

- By unlocking the vehicle using the button on the assigned vehicle key.
- By unlocking the vehicle using a door handle. The assigned vehicle key or the assigned Digital Key must be carried with you.
- By unlocking automatically when approaching the vehicle. The assigned vehicle key or the assigned Digital Key must be carried with you. Depending on



the country, it may not be possible to recognize the Digital Key.

If multiple vehicle keys or digital keys are near the vehicle, MINI IDs are activated according to the following priority:

- The key that unlocks the vehicle triggers activation of the assigned MINI ID.
- If a vehicle key and digital key are detected at the same time, the digital key triggers activation of the assigned MINI ID.
- The MINI ID of the key last detected on the driver's door is activated.

If the MINI ID could not be detected when the vehicle was unlocked, select the MINI ID on the welcome window.

Setting/adjusting automatic driver recognition

1.  To set or adjust automatic driver recognition, tap the MINI ID icon or profile image on the status bar.
2. "Settings"
3. "Driver recognition"
4. Select the desired setting.

Transfer of the vehicle key

A vehicle key assigned to a MINI ID can be used to view or edit personal settings.

Before a vehicle key is transferred to other persons, any assigned driver detection should be canceled. Driver recognition can be configured in the MINI ID settings.

With MINI Digital Key, a digital key can be given to other people so that they are able to use the associated vehicle.

Additional information:

MINI Digital Key, refer to page 80.

Selecting a profile picture

The profile picture can be selected from the predefined profile pictures.

1.  To select a profile image, tap the MINI ID icon or profile image on the status bar.
2. Select the desired MINI ID.
3. "Settings"
4. "My MINI ID"
5. "Picture"
6. Select the desired profile picture.

The profile picture from the MINI app profile can be used for MINI IDs. To do so, synchronization with the MINI Cloud must be enabled in the settings. Once a profile picture is taken from the MINI app, the default profile images can only be used if the profile picture on the MINI app is deleted or synchronization is disabled.

Setting synchronization

Principle

If synchronization is on, settings from the following areas, for example, are synchronized:

- The MINI ID, e.g., the profile picture.
- Navigation, e.g., recent destinations, home address, or map settings.
- Media, e.g., favorites or saved radio stations.
- The Interaction Unit, e.g., the main menu configuration, language or, units.
- The Personal Assistant, e.g., suggestions or the activation word.
- Exterior lighting, e.g., one-touch signaling and pathway lighting.

Settings from the following areas are only synchronized when logging in for the first time:

- Seat and climate comfort functions, e.g., driver's seat position or temperature setting.
- Privacy menu.

Turning synchronization on/off

1.  To enable/disable settings synchronization, tap the MINI ID icon or profile image on the status bar.
2. "Settings"
3. "My MINI ID"
4. Select the desired setting.

The profile picture can also be set if it was not already adopted from the MINI app.

Configuring PIN protection

Once saved, MINI IDs can be selected by every user of the vehicle. Set a PIN to prevent the MINI ID's settings from being changed and the MINI ID's data from being viewed.

1.  To set a PIN, tap the MINI ID icon or profile image on the status bar.
2. Select the desired MINI ID.
3. "Settings"
4. "Lock screen"
5. Enter the desired PIN.

Profile management



Editing profiles

The profile can be changed at any time using the Interaction Unit:

1.  Tap the MINI ID icon or profile picture on the status bar.
2. "Change profile"
3. Select the desired MINI ID or profile.
4. If necessary, enter a PIN.

The MINI ID is activated and associated settings are loaded.

Deleting a MINI ID

1.  To delete a MINI ID, tap the MINI ID icon or profile image on the status bar.
2. "Settings"
3. "Manage profiles"
4.  Tap the icon to delete the desired MINI ID.

When deleting MINI IDs, note the following:

- Removing a MINI ID from the vehicle causes the vehicle to be removed from the MINI app. If the MINI ID has been synchronized with the MINI Cloud, data saved to the MINI Cloud is kept after the MINI ID is deleted. If the currently active MINI ID is removed, another profile must be selected.
- Deleting the primary user's MINI ID resets the vehicle to factory settings. The vehicle is removed from each user's MINI app, and all MINI IDs are removed from the vehicle.
- Removing a vehicle from the MINI app removes the corresponding MINI ID from the vehicle. If the MINI ID was synchronized with the MINI Cloud, MINI ID data saved to the MINI Cloud is kept.
- If the vehicle is removed from the primary user's MINI app, it will also be removed from each user's MINI app. The corresponding MINI IDs are removed from the vehicle.

Additional profiles

Principle

Additional profiles can be used to operate the vehicle without a MINI ID.



Driver profile

"Driver ": If no MINI ID is available, vehicle settings can be saved to this profile.

This profile is subject to the following restrictions, among others:

- Driver cannot be detected automatically.
- The name and profile image cannot be changed.
- There is no synchronization with the MINI Cloud.
- Certain functions are not available, e.g., navigation functions or saving favorites.

The profile, and the settings saved to it, can be transferred to a MINI ID. The MINI ID is then displayed instead of the profile.

Guest profile

"Guest": This profile can be used to operate the vehicle without changing the settings saved for other profiles.

This profile is subject to the following restrictions, among others:

- Changed settings are not saved.
- It is not possible to specify automatic driver recognition or assign a PIN.
- The name and profile image cannot be changed.
- There is no synchronization with the MINI Cloud.
- Certain functions are not available, e.g., navigation functions or saving favorites.

System limits

It may not be possible to clearly identify the driver using the vehicle key or digital key in the following situations, for example:

- The driver changes, but the vehicle is not locked and unlocked.
- If one MINI ID is assigned to multiple vehicle keys or multiple digital keys that

are located outside the driver's side of the vehicle.

- If the vehicle was unlocked from the MINI app.

There are technical limitations when using personal settings for a MINI ID in other vehicles. For example, settings may be stored for a system that is not available in other vehicles, or available in a non-compatible version.

Driver profiles

Principle

Driver profiles can be used in countries where MINI Connected is not available in order to save and enable personal settings in the vehicle.

Your vehicle can save up to seven driver profiles. If a vehicle is used by several people, each person can use their own driver profile in the vehicle. The guest driver profile can be used when driving the vehicle without a driver profile.

Automatic driver recognition can activate a driver profile as soon as the vehicle is unlocked. To do so, a vehicle key must be linked to the driver profile.

Functional requirement

The vehicle must be stationary to create, change, delete, or edit a driver profile.

Welcome window

A welcome window appears on the Interaction Unit after the vehicle is unlocked. The type of the welcome depends on the following prerequisites:

- No driver profile is saved to the vehicle:

The welcome is neutral. A new driver profile can be added.

- Vehicle key has not been assigned to a driver profile:

The welcome is neutral. Saved driver profiles are shown for selection. A new driver profile can be added.

- A driver profile has been assigned to the vehicle key:

The welcome is personalized, the stored settings are activated. The available driver profiles are shown for selection. A new driver profile can be added.

Driver profile, driver

"Driver": A driver profile allows the driver to save individual vehicle settings as well as create a name for this profile and select a profile image.

Driver profile, guest

"Guest": This driver profile can be used to operate the vehicle without changing the settings saved for other driver profiles.

This profile is subject to the following restrictions, among others:

- Changed settings are not saved.
- It is not possible to specify automatic driver recognition or assign a PIN.
- The name and profile image cannot be changed.

Adding a driver profile

1.  To add a driver profile, tap the driver profile icon or profile picture on the status bar.
2. "Add profile"
3. Change additional settings as necessary, e.g., automatic driver recognition.

Personalized settings

Automatic driver recognition

Principle

Automatic driver recognition can activate a driver profile as soon as the vehicle is unlocked. To do so, a vehicle key must be assigned to the driver profile. After unlocking, you can change the driver profile.

If driver recognition has been configured, automatic activation of the driver profile is triggered by the following:

- By unlocking the vehicle using the button on the assigned vehicle key.
- By unlocking the vehicle using a door handle. You must carry your assigned vehicle key with you.
- By automatic unlocking when approaching the vehicle. You must carry your assigned vehicle key with you.

If multiple vehicle keys are near the vehicle, driver profiles are activated according to the following priority:

- The key that unlocks the vehicle triggers activation of the assigned driver profile.
- The driver profile of the key last detected at the driver's door is activated.

If the driver profile could not be detected when unlocking the vehicle, select the desired driver profile in the welcome window.

Setting/adjusting automatic driver recognition

1.  To set or adjust automatic driver recognition, tap the MINI ID icon or profile image on the status bar.
2. "Settings"
3. "Driver recognition"
4. Select the desired setting.



Transfer of the vehicle key

A vehicle key assigned to a driver profile can be used to view or change saved personal settings.

Before a vehicle key is transferred to other persons, any assigned driver detection should be canceled.

You can configure driver recognition in the driver profile settings.

Configuring PIN protection

Once saved, driver profiles can be selected by every user of the vehicle. If you want to prevent settings from being changed or data from being viewed for a driver profile, it is possible to set PIN protection.

1.  Tap the driver profile icon or profile picture on the status bar.
2. Select the desired driver profile.
3. "Settings"
4. "Lock screen"
5. Enter the desired PIN.

Profile management



Changing driver profiles

The driver profile can be changed at any time using the Interaction Unit:

1.  Tap the driver profile icon or profile picture on the status bar.
2. "Change profile"
3. Select the desired driver profile.
4. If necessary, enter a PIN.

The driver profile is activated and associated settings are loaded.

Deleting the driver profile

1.  To delete a driver profile, tap the driver profile icon or profile picture on the status bar.
2. "Settings"
3. "Manage profiles"
4.  Tap the icon to delete the desired driver profile.

System limits

It may not be possible to clearly identify the driver using the vehicle key in the following situations, for example:

- The driver changes, but the vehicle is not locked and unlocked.
- If multiple vehicle keys with assigned driver profiles are located on the driver's side of the vehicle.

Opening and closing

Vehicle features and options

This chapter describes model-specific equipment, systems, and functions that are currently available, or may become available in the future, even if they are not present in the vehicle.

Additional information:

Vehicle equipment, refer to page 8.

Vehicle key

Principle

Two vehicle keys are included in the scope of delivery, each containing an integrated key.

Each vehicle key contains a replaceable battery. If the vehicle key's battery is discharged, the vehicle key will not be detected. In this case, drive-ready state can be turned on by emergency detection of the vehicle key.

Depending on the equipment and national-market version, various settings are possible for the button functions.

A MINI ID or driver profile with personal settings can be assigned to a vehicle key.

To provide information on maintenance recommendations, the service data is stored in the vehicle key.

To prevent possible locking in of the vehicle key, take the vehicle key with you when exiting the vehicle.

Safety information



Warning



The vehicle key has a button cell battery. Batteries or button cell batteries can be swallowed and lead to serious or fatal injuries within two hours, for example due to internal burns or chemical burns. There is a risk of injury or danger to life. Keep the vehicle key and batteries out of reach of children. Immediately seek medical help if there is any suspicion that a battery or button cell battery has been swallowed or is located in any part of the body.

Overview



Buttons on the vehicle key.

Icon	Meaning
	Unlock.
	Lock.
	Stationary climate control, refer to page 253.

Icon	Meaning
	Unlock the trunk.
	Panic mode. Pathway lighting, refer to page 153.

Additional vehicle keys

Additional vehicle keys are available from an authorized service center or another qualified service center or repair shop.

Loss of vehicle keys

A lost vehicle key can be disabled and replaced by an authorized service center or another qualified service center or repair shop.

If a MINI ID or driver profile was assigned to the lost vehicle key, the association to this vehicle key must be deleted. A new vehicle key can then be assigned to the MINI ID or driver profile.

Replacing the battery

NOTICE

Improper batteries in a battery-operated device can damage the device. There is a risk of damage to property. Always replace the discharged battery with a battery with the same voltage, the same size and the same specification.

To replace the vehicle key battery, proceed as follows:

1. Press and hold the button, arrow 1, then pull the cover, arrow 2, out of the locking mechanism from the bottom end.



2. Pull the cover out of the upper locking mechanism, arrow, then remove the cover.



3. Use a coin to open the battery compartment lid, turning the coin counterclockwise.

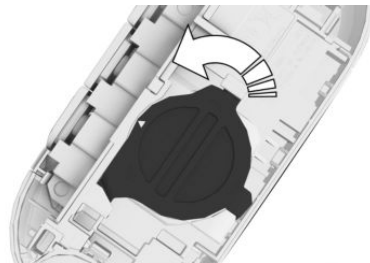

- Remove the battery from the battery housing.



- Insert a CR2032 3V battery with the positive terminal facing up.
- Use a coin to close the battery compartment lid, turning the coin clockwise, arrow 1. The lid is fully closed when the arrowheads, arrow 2, point toward each other.

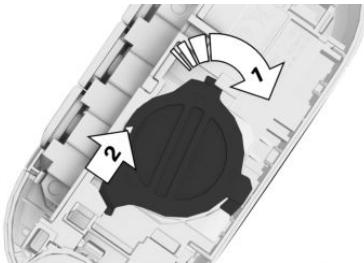

- Insert the cover in reverse order, arrow 1 and arrow 2. The cover must audibly engage at the top and bottom.



Have old batteries disposed of by an authorized service center or an-

other qualified service center or repair shop, or take them to a collection point.

Integrated key

Principle

The integrated key is built into the vehicle key. If the electrical system malfunctions, the vehicle can be unlocked and locked manually using the integrated key.

Depending on the national-market version, the integrated key will fit in the glove compartment.

Safety information

Warning

For some national-market versions, unlocking from the inside is only possible with particular knowledge.

If persons or animals spend a lengthy time in the vehicle and are thereby exposed to extreme temperatures, there is a risk of injury or danger to life. Do not lock the vehicle from the outside when there are people or animals in it. Do not leave babies, toddlers or animals alone in the vehicle.



Removing the integrated key

1. Press and hold the button, arrow 1, then push the cover, arrow 2, downward and remove it.

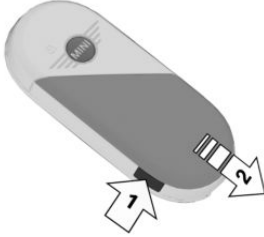

2. Push the end of the key head, arrow. The integrated key is raised slightly.
3. Remove the integrated key.

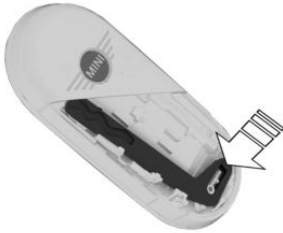

Unlocking the vehicle manually

1. Remove the cover cap on the door handle to make the door lock accessible. To do this, slide the integrated key into the

opening to the stop from below and remove the cover cap.

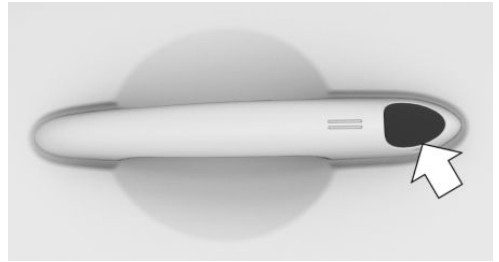

2. Unlock the door lock with the integrated key by turning it counterclockwise.
3. Open the driver's door.
4. Press the central locking button to unlock the other doors. With the vehicle de-energized: pull the door opener of the other doors from the inside.

Locking the vehicle manually

General information

To avoid locking the vehicle key in the vehicle, do not place the vehicle key in the vehicle.

Locking the vehicle

1. Close all doors.
2. Enter the vehicle on the front passenger's side and close the front passenger door.
3. Press the central locking button to unlock all doors.
4. Exit the vehicle through the front passenger door.

5. With the integrated key, close and lock the front passenger door using the side door lock.

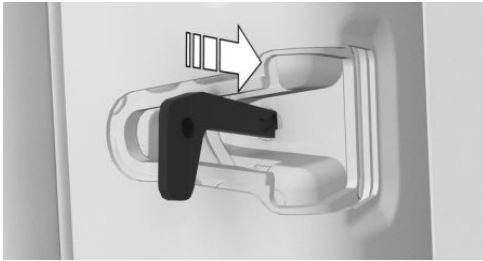

6. Pull the door handles to make sure they are locked. If necessary, repeat the process.

If vehicle is de-energized:

1. With the integrated key, close and lock all doors, except the driver's door, using the side door lock.

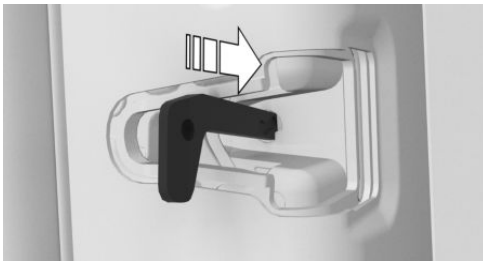

2. Pull and hold the driver's door handle outward with one hand.



3. Using the integrated key, lock the driver's door lock clockwise.

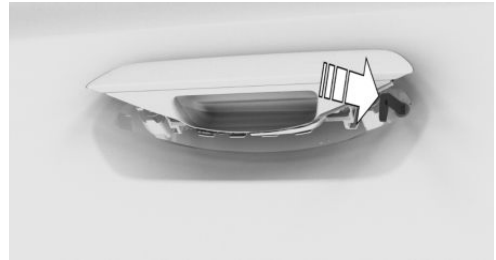

4. Pull out the vehicle key and release the door handle.
5. Close the driver's door.
6. Pull the door handles to make sure they are locked. If necessary, repeat the process.

Alarm system

If the vehicle is unlocked with the integrated key via the door lock, the activated alarm system will be triggered when the door is opened.

In this case, use the vehicle key emergency detection to switch off the alarm.

If the doors are manually locked from the inside, the alarm system is not activated.

Emergency detection of the vehicle key

Principle

If the vehicle key's battery is discharged, the vehicle key will not be detected. In this case, drive-ready state can be turned on by emergency detection of the vehicle key.

Turning on the drive-ready state

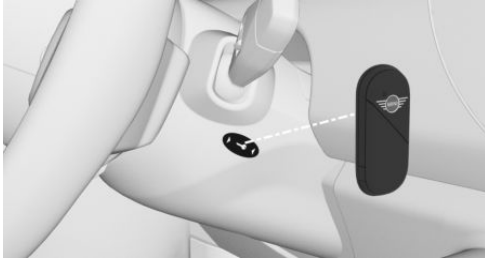

1. To turn on drive-ready state via emergency detection of the vehicle key, hold the back of the vehicle key to the marking on the steering column. Pay attention to the view shown on the Interaction Unit.
2.
 - If the vehicle key is detected: Turn on drive-ready state within 10 seconds.
 - If the vehicle key is not detected: Slightly change the position of the vehicle key and repeat the procedure.

Malfuction

A Check Control message is displayed where applicable.

Vehicle key detection by the vehicle may malfunction under the following circumstances:

- The battery of the vehicle key is discharged.
- Fault of the radio link from transmission towers or other equipment with high transmitting power.
- Shielding of the vehicle key due to metal objects.
Do not transport the vehicle key together with metal objects.
- Fault of the radio link from mobile phones or other electronic devices in direct proximity to the vehicle key.

Do not carry the vehicle key in close proximity to other electronic devices.

- Fault of radio transmission by a charging process of mobile devices, for instance charging of a mobile phone.
- The vehicle key is located in direct proximity of the wireless charging tray.
Place the vehicle key in a different location.

In the case of interference, the vehicle can also be unlocked and locked from the outside with the integrated key. Use the Emergency detection of the vehicle key to turn on drive-ready state.

Access to vehicle interior

Principle

The vehicle can be unlocked/locked as follows:

- With the vehicle key.
- Using the door handle.
- With the Key Card.
- With the MINI Digital Key.
- Hands-free unlocking/locking

Safety information

Warning

People or animals in the vehicle can lock the doors from the inside and lock themselves in. In this case, the vehicle cannot be opened from the outside. There is a risk of injury. Take the vehicle key with you so that the vehicle can be opened from the outside.



Warning

For some national-market versions, unlocking from the inside is only possible with particular knowledge.

If persons or animals spend a lengthy time in the vehicle and are thereby exposed to extreme temperatures, there is a risk of injury or danger to life. Do not lock the vehicle from the outside when there are people or animals in it. Do not leave babies, toddlers or animals alone in the vehicle.

Warning

Unattended children or animals in the vehicle can cause the vehicle to move and endanger themselves and traffic, for example, due to the following actions:

- Establishing standby.
- Releasing the parking brake.
- Opening and closing the doors or windows.
- Engaging selector lever position N.
- Using vehicle equipment.

There is a risk of accident, injury, or property damage. Do not leave children or animals unattended in the vehicle. Take the vehicle key with you when exiting and lock the vehicle.

NOTICE

The window will be lowered slightly when pulling on the door handle. In the event of frost, the window may be frozen solid and may not be able to be lowered. There is a risk of damage to property. When pulling on the door handle, make sure that the window is lowered. If necessary, remove snow and ice from the window. Do not open the door with force.

Actions during unlocking

Depending on the settings, the following functions are performed when unlocking the vehicle:

- Only the driver's door and the fuel filler flap will be unlocked or all access to the vehicle will be unlocked.
- The unlocking of the vehicle can be confirmed with a light signal or a sound signal.
- The welcome light can be turned on when the vehicle is being unlocked.

In addition, the following functions are executed:

- If a MINI ID or driver profile was assigned to the vehicle key, this MINI ID or driver profile will be enabled.
- The interior lights are switched on, unless they were manually switched off.
- Depending on vehicle equipment, folded-in exterior mirrors are folded out. If the exterior mirrors were folded in using the button inside the vehicle, they will not fold out when the vehicle is unlocked.
- Anti-theft protection is switched off.
- The alarm system is switched off.

Additional information:

- Settings, refer to page 84.
- Welcome lights, refer to page 152.
- MINI ID, refer to page 60.
- Driver profiles, refer to page 64.

Actions during locking

Depending on the settings, the following functions are performed when locking the vehicle:



- The locking of the vehicle can be confirmed with a light signal or a sound signal.
- Depending on vehicle equipment, the exterior mirrors can be folded in automatically when locking. The exterior mirrors are not folded in when the hazard warning flashers are switched on.

The following functions are executed:

- All doors, the trunk, and the fuel filler flap are locked.
- Anti-theft protection is switched on. This prevents the doors from being unlocked using the lock buttons or the door openers.
- The alarm system is switched on.

If the drive-ready state is still turned on when you lock the vehicle, the vehicle horn will honk twice. In this case, drive-ready state must be turned off using the Start/Stop switch.

Additional information:

Settings, refer to page 84.

With the vehicle key

Unlocking the vehicle



To unlock the vehicle using the vehicle key, press the unlock button on the vehicle key.

If only the driver's door and fuel filler flap have been unlocked due to the settings in place, press the button on the vehicle key again to unlock the other vehicle access points.

After opening one of the front doors, the vehicle is ready for operation.

The lighting functions may depend on the ambient brightness.

Locking the vehicle

1. To lock the vehicle using the vehicle key, close the driver's door.



2. Press the lock button on the vehicle key.

On the door handle

Principle

The vehicle can be accessed without using the vehicle key.

The vehicle key is automatically detected near the vehicle.

General information

Function availability depends on vehicle equipment.

Depending on national-market version, the vehicle can also be unlocked and locked via the door handle using a compatible smartphone and digital key.

Additional information:

MINI Digital Key, refer to page 80.

Functional requirements

To get inside the vehicle using the door handle, the following functional requirements must be met:

- Carry the vehicle key with you, e.g., in your pants pocket.
- Bluetooth must be activated on the smartphone to unlock and lock using the Digital Key.
- To lock the vehicle, the vehicle key must be outside of the vehicle near the doors.
- After locking, approx. 2 seconds must elapse before unlocking is possible.

Unlocking the vehicle using the door handle

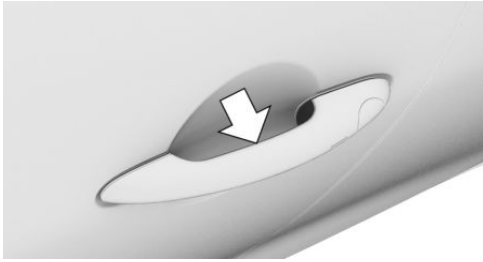

To unlock the vehicle using the door handle, reach into the recessed grip on the driver's door.

Locking the vehicle with the door handle

1. To lock the vehicle using the door handle, close the driver's door.
2. While carrying the vehicle key, touch the grooved surface on the closed driver's door handle with your finger approx. 1 second and hold it there without reaching into the recessed grip.

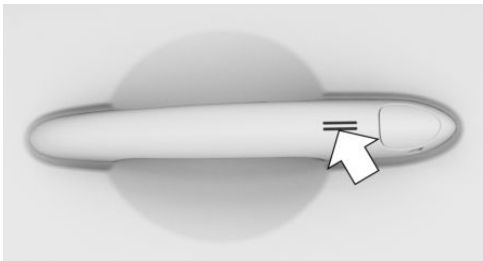

Malfunction

Wet or snowy conditions may disrupt the locking request detection on the door handles.

In the case of a malfunction, unlock and lock the vehicle using the buttons of the vehicle key or use the integrated key.

Touchless unlocking/locking of the vehicle

Principle

The vehicle will be unlocked when an authorized vehicle key is detected in the unlocking zone.

The unlocking zone is located within a radius of approx. 5 ft/1.50 m around the side and rear of the vehicle.

The vehicle will be locked when the vehicle key leaves the locking zone.

The locking zone is located within a radius of approx. 9 ft/3 m around the side and rear of the vehicle.

Automatic unlocking and locking must be activated in the settings.

General information

The function is available with Comfort Access.

Depending on the national-market version, touchless unlocking and locking is also possible for compatible smartphones with a digital key. Enable Bluetooth on your smartphone to do so.

If the vehicle key is located in the unlocking zone for an extended period of time without movement, the vehicle will be locked automatically.

If someone is detected on a seat while locking the vehicle, the following restrictions apply:

- The vehicle will be locked but not secured against theft.
- The fuel filler flap remains unlocked.

Additional information:

MINI Digital Key, refer to page 80.

Actions during unlocking

If the settings specify that only the driver's door and the fuel filler flap will be unlocked, note the following:

The driver's door and fuel filler flap will only be unlocked when the driver approaches the vehicle on the driver's side.

Additional information:

Settings, refer to page [84](#).

Functional requirements

To unlock/lock the vehicle hands-free, the following functional requirements must be met:

- Carry the vehicle key with you, e.g., in your pants pocket.
- Bluetooth must be activated on the smartphone for contactless unlocking and locking using the Digital Key.
- Automatic unlocking and locking must be activated in the settings.
- The drive-ready state must be turned off.
- If the vehicle has been in the idle state for several days, contactless unlocking/locking will only be available after the vehicle has been driven.

Additional information:

Settings, refer to page [84](#).

With the Key Card

Principle

The Key Card is a chip card on which the digital key is installed. The Key Card can be used to unlock and lock the vehicle.

Additional information:

Key Card, refer to page [79](#).

General information

The Key Card is available with Comfort Access.

Unlocking/locking the vehicle with the Key Card

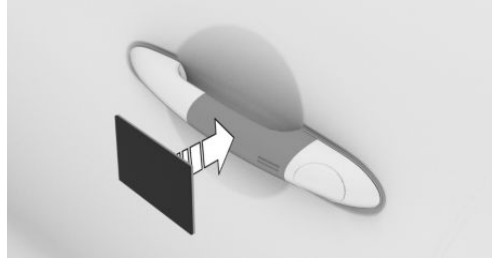

To unlock/lock the vehicle using the Key Card, hold the activated Key Card directly over the middle of the driver's door handle.

When locking the vehicle with the Key Card, make sure that all doors and the trunk are closed.

If the Key Card is not detected, slightly change the position of the Key Card and repeat the procedure.

With MINI Digital Key

Principle

Depending on vehicle equipment and national-market version, a digital key can be installed on a compatible smartphone and used to unlock and lock the vehicle.

Additional information:

MINI Digital Key, refer to page [80](#).

Unlocking/locking the vehicle with the MINI Digital Key

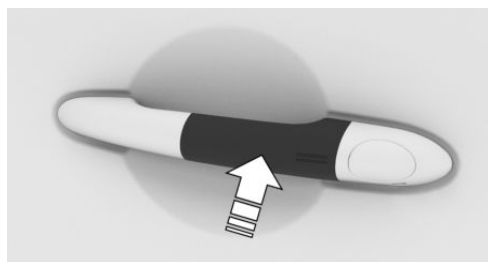

To unlock/lock the vehicle with the MINI Digital Key, hold the smartphone's NFC antenna directly over the middle of the driver's door handle. The position of the near field communication antenna depends on the smartphone model.

When locking the vehicle with the smartphone, make sure that all doors and the trunk are closed.

Frequently Asked Questions

What precautions can be taken to be able to open a vehicle, despite accidentally locking in the vehicle key?

- The MINI app's Remote Services include options for locking/unlocking a vehicle, among others.

This requires an active MINI Connected contract and the MINI app must be installed on a smartphone.

- Unlocking the vehicle can be requested via the MINI Connected Call Center.

An active MINI Connected contract is required.

Access to the cargo area

Principle

The trunk can be opened as follows:

- With the vehicle key.
- In the trunk.
- Inside the vehicle.

Safety information

Warning

Body parts can be jammed when operating the tailgate. There is a risk of injury. Make sure that the travel path of the tailgate is clear during opening and closing.

Warning

The tailgate swings back and up when it opens. There is a risk of injury or risk of damage to property. Make sure that the travel path of the tailgate is clear during opening and closing.

Warning

Sharp-edged or pointed objects can hit the windows and heating elements while driving. There is a risk of injury or risk of damage to property. Cover the edges and ensure that pointed objects do not hit the windows.

With the vehicle key

General information

To avoid locking the vehicle key in the vehicle, do not place the vehicle key in the cargo area.

Depending on vehicle equipment and national-market version, the following settings can be changed:



- Unlocking the cargo area with the vehicle key also unlocks the doors.
- Before unlocking the cargo area with the vehicle key, first unlock the vehicle.

Functional requirements

To access the trunk using the vehicle key, the following functional requirements must be met:

- Selector lever position P must be engaged to open the cargo area with the vehicle key.
- You must enable the setting for opening with the vehicle key.

Additional information:

Settings, refer to page 84.

Unlocking the trunk



On the vehicle key, press and hold the trunk button for approx. 1 second.

On the trunk

General information

Depending on vehicle equipment, the cargo area can be accessed without operating the vehicle key.

The key is automatically detected near the vehicle.

Depending on the national-market version, compatible smartphones with a digital key are also detected automatically. In this case, the cargo area can be opened with a smartphone.

Additional information:

MINI Digital Key, refer to page 80.

Functional requirements

To access the cargo area using the trunk, the following functional requirements must be met:

- Carry the vehicle key with you, e.g., in your pants pocket.
- Bluetooth must be activated on the smartphone to detect the Digital Key.

Opening the cargo area

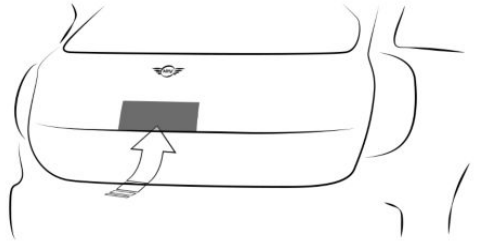

The trunk can be opened as follows:

- Unlock the vehicle, then press the button on the trunk.
- With Comfort Access: Carry the vehicle key with you and press the button on the trunk.

Locked doors are not unlocked.

Swivel the tailgate upward.

Closing the cargo area

Grasp the recessed grips and pull the tailgate down.

Inside the vehicle

Functional prerequisite

When the vehicle is locked, selector lever position P must be engaged before the trunk lid can be opened using the button in the vehicle interior.

Unlocking the trunk



In the storage compartment on the driver's door, press the button for opening the trunk.

Key Card

Principle

The Key Card allows the vehicle to be unlocked and locked, as well as started.

A digital key that has already been paired with the vehicle is installed on the Key Card. The digital key must be activated on the Interaction Unit.

General information

Key Card availability depends on vehicle equipment and national-market version. Before leaving the vehicle, deactivate the Key Card or take the Key Card with you because the active Key Card can be used to start the vehicle. Always take the vehicle key with you to a service appointment.

Safety information

NOTICE

If the Key Card and a mobile device are in the wireless charging tray at the same time, the Key Card could become damaged. There is a risk of damage to property. Do not place the Key Card in the wireless charging tray at the same time as a mobile device.

Activating/deactivating Key Card in the vehicle

General information

When MINI Digital Key is activated for the vehicle, a digital key can be used instead of the vehicle key.

A deactivated Key Card remains in the list of paired digital keys.

Functional requirement

A vehicle key must be located in the vehicle to activate and deactivate the Key Card.

Activating Key Card

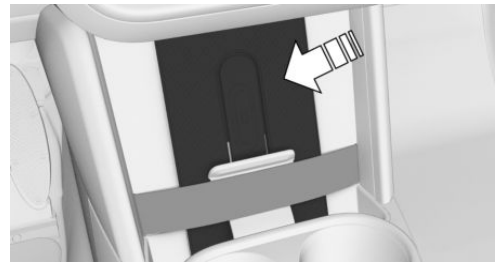

1. To activate the Key Card, place the Key Card in the center of the tray on the center console and slide it down behind the holder.
2. Follow the instructions on the Interaction Unit.

Deactivating Key Card

To deactivate the Key Card, go through the menu as follows: Apps menu / "Vehicle" / "Doors and windows" / "Vehicle key" / "Key Card" / "Deactivate Key Card".

A deactivated Key Card remains in the list of paired digital keys.

Unlocking and locking the vehicle

The vehicle can be unlocked and locked with the activated Key Card.



Additional information:

Access to the vehicle interior, refer to page 72.

Turning on drive-ready state with the Key Card

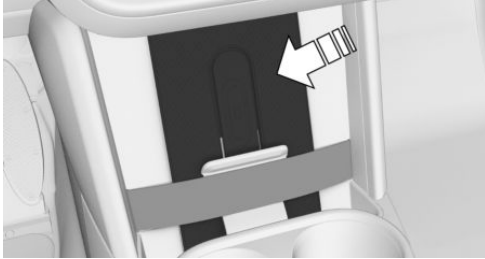

1. To turn on drive-ready state using the Key Card, place the activated Key Card in the center of the tray on the center console and slide it down behind the holder.
2. Turn the Start/Stop switch to activate drive-ready state.

After drive-ready state is switched on, the Key Card can be removed from the tray.

Malfunction

The vehicle may not be able to detect the Key Card if there are objects between the smartphone tray and the Key Card, e.g., a wallet or smartphone case.

MINI Digital Key

Principle

The MINI Digital Key makes it possible to unlock, lock, and start the vehicle using a digital key.

MINI Digital Key can be used with a compatible smartphone or other compatible mobile device.

To unlock and start a vehicle with a compatible smartphone, this function must be offered by the smartphone manufacturer. The MINI app is able to check whether the smartphone and vehicle are compatible as well as determine which functions are supported.

Each vehicle can be provided with a main digital key. Additional digital keys can be shared and then deleted.

General information

MINI Digital Key availability and functionality depend on vehicle equipment and national-market version.

A MINI ID or driver profile with individual settings can be assigned to a digital key.

When using a smartphone as a digital key, it is helpful to carry the deactivated Key Card in the vehicle. In situations where the vehicle is to be given to another person, they can be given the Key Card instead of the smartphone. To do so, the Key Card must be activated via the Interaction Unit.

Always take the vehicle key with you to a service appointment.

Additional information:

- MINI ID, refer to page 60.
- Driver profiles, refer to page 64.
- Key Card, refer to page 79.

The MINI website provides additional information under the keyword “digital key”.

Functional requirements

The following functional requirements must be met for MINI Digital Key:

- The smartphone is compatible with MINI Digital Key
- The vehicle is linked with the vehicle owner's MINI Connected account.
- The rechargeable battery of the smartphone has a sufficient charge. The nec-

essary minimum charge of the rechargeable battery depends on the smartphone.

- Bluetooth must be activated on the smartphone for contactless unlocking and locking using the Digital Key.

Enabling the main digital key

Vehicle owner's smartphone is enabled as a main digital key in the vehicle. The vehicle owner must prove his authorization for the vehicle for this purpose.

The MINI app can be used to provide verification for authorization, or the activation code can be used on the corresponding smartphone app, e.g., Wallet. Both vehicle keys must be in the vehicle during activation.

Follow the instructions in the Digital Key menu on the MINI app or Interaction Unit.

Sharing digital keys

General information

The MINI Digital Key makes it possible to share digital keys with other people. This option is available via the smartphone that is enabled as main digital key. This function must be supported by the smartphone.

Forwarding authorization

To share the digital key, select the corresponding function on the smartphone, for instance in the Wallet app.

As soon as a digital key is shared with another person, the person will receive an invitation. When the invitation is accepted, the digital key on the recipient's smartphone will be activated.

Limiting the range of functions

Certain functions of the digital key can be limited before handing it over. For example, you can disable restrictions for driving

stability control systems and reduce the engine power before giving your Digital Key to a novice driver. For more information, refer to the MINI Connected portal and MINI app.

Authentication

Depending on the recipient's smartphone model, an authentication may be required for security and safety reasons.

An authorized vehicle key, the main digital key or another method may be used for authentication. Follow the instructions given on the smartphone or Interaction Unit.

Deleting digital keys

General information

Deleted digital keys will be removed from the list of enabled digital keys.

Deleted digital keys cannot be restored.

Deleting the main digital key

The main digital key can be deleted using the smartphone or Interaction Unit.

The deletion of the main digital key is completed immediately.

Deleting a shared key

Shared keys can be deleted using the smartphone with the main digital key, using the smartphone with a shared key, or using the Interaction Unit.

The deletion via the smartphone using the main digital key will not be performed until the vehicle is used with a key other than the key to be deleted.

Keys are deleted immediately when using the smartphone with shared key or the Interaction Unit to do so.



Deleting a digital key via the Interaction Unit

To delete a digital key using the Interaction Unit, either an authorized vehicle key must be located in the vehicle or the main digital key must be located in the smartphone tray.

1. Go through the menu as follows:
Apps menu / "Vehicle" / "Doors and windows" / "Vehicle key" / "Digital Key".
2. If necessary, select the digital key.
3. "Delete key"

Resetting the function

To reset the MINI Digital Key function, an authorized vehicle key must be located in the vehicle.

When resetting the MINI Digital Key, all digital keys will be deleted, including the main digital key. The Key Card's digital key is retained and deactivated.

After the reset, the vehicle can no longer be unlocked, locked or started with a digital key.

The main digital key must be enabled again to use MINI Digital Key again.

To reactivate the main digital key, go through the menu as follows: Apps menu / "Vehicle" / "Doors and windows" / "Vehicle key" / "Digital Key" / "Reset function".

Unlocking and locking the vehicle

The vehicle can be unlocked and locked as follows:

- Using the door handle.
- Depending on vehicle equipment and national-market version, the vehicle can be locked and unlocked with no-touch activation.

MINI Digital Key availability and functionality depend on vehicle equipment and national-market version.

Additional information:

Access to the vehicle interior, refer to page 72.

Turning on drive-ready state with MINI Digital Key

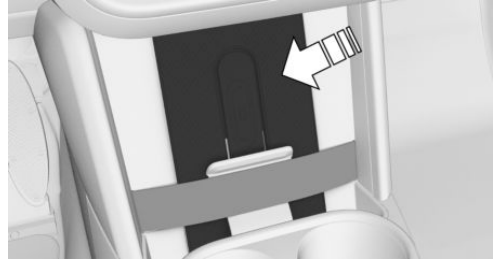

1. To turn on drive-ready state with the MINI Digital Key, place the smartphone in the center of the tray on the center console and slide it down behind the holder.

Ensure that the display is facing up.

2. Turn the Start/Stop switch to activate drive-ready state.

With Comfort Access, it is sufficient, depending on the country, for the smartphone with Bluetooth enabled to be located inside the vehicle. Turn the Start/Stop switch to activate drive-ready state.

Sale of the smartphone

Delete all digital keys on the smartphone prior to selling the smartphone. This ensures that the smartphone can no longer be used for the vehicle.

Changing smartphones

To use a new smartphone as a master Digital Key, activate the new smartphone according to the instructions for the master Digital Key. The previous master key is deleted when the new smartphone is activated.

Sale of the vehicle

Prior to selling a vehicle, reset the MINI Digital Key function or remove the vehicle from the current vehicle owner's MINI Connected account.

When the vehicle is removed from the MINI Connected account, all digital keys for the vehicle will be deleted. The Key Card's digital key is retained and deactivated.

System limits

With a digital key, the alarm system's interior motion sensor and tilt alarm sensor can only be deactivated using the Interaction Unit.

Additional information:

Alarm system, refer to page 85.

Malfunction

Your Digital Key may not be detected by the vehicle under the following circumstances:

- The smartphone is shielded from the sensors in the vehicle by a smartphone cover that is not suitable.
- There is an object, e.g., chip card or Key Card, between the smartphone and smartphone cover.
- The connection has been interrupted by a transmission tower or other device with a high transmitting power.
- The smartphone is shielded by a building or metallic object.

Buttons for the central locking system

Principle

The vehicle can be locked/unlocked from the inside using the buttons for the central locking system.

The vehicle is automatically locked when driving off.

In the event of a severe accident, the vehicle is automatically unlocked. The hazard warning system and interior lights are illuminated.

Overview



The central locking system buttons are located on the driver's door.

Locking the vehicle from inside



To lock the vehicle from the inside, press the lock button on the driver's door when the doors are closed.

The fuel filler flap remains unlocked.

The vehicle is not secured against theft when locking.

Unlocking the vehicle from inside



To unlock the vehicle from the inside, press the unlock button on the driver's door.

Opening the door

When the vehicle is locked, doors can be opened as follows:

-  On the front door, press the unlock button to unlock the doors together.



Pull the door opener on the door to be opened.

- Front doors: Pull the door opener on the door to be opened. The other doors remain locked.
- Rear doors: Pull the door opener on the door to be opened twice: The first time unlocks the door, the second time opens it. The other doors remain locked.

Settings

General information

Depending on the equipment and national-market version, various settings for opening and closing are possible.

Unlocking and locking

Doors

1. Go through the menu as follows:
Apps menu / "Vehicle" / "Doors and windows" / "Lock" / "Doors and windows" / "Unlock".
2. Select the desired setting:
 - "Driver's door only"
Only the driver's door and fuel filler flap are unlocked. Pressing again unlocks the entire vehicle.
 - "All doors"
The entire vehicle is unlocked.

Touchless unlocking/locking

1. Go through the menu as follows:
Apps menu / "Vehicle" / "Doors and windows" / "Lock" / "Doors and windows".
2. Select the desired setting:
 - "Unlock when approaching"
 - "Lock when walking away"

Enabling this setting also activates automatic folding of the mirrors. Automatic folding of the mirrors can be deactivated again in the corresponding menu.

Automatic unlocking

1. Go through the menu as follows:
Apps menu / "Vehicle" / "Doors and windows" / "Lock" / "Doors and windows".
2. Select the desired setting:
 - "Unlock doors at end of trip"
 - "Doors will unlock automatically when in P."

If locked, the vehicle unlocks automatically when drive-ready state is turned off or selector lever position P is engaged.

Automatic locking

Go through the menu as follows:
Apps menu / "Vehicle" / "Doors and windows" / "Lock" / "Doors and windows" / "Lock after a short time".

The vehicle locks automatically after a short period of time if no door is opened after unlocking.

Confirmation signals from the vehicle

1. Go through the menu as follows:
Apps menu / "Vehicle" / "Doors and windows" / "Lock" / "Doors and windows".
2. Select the desired setting:
 - "Flash when unlocking"
Unlocking is confirmed by two flashes.
 - "Flash when locking"
Locking is confirmed by one flash.
 - With alarm system:
"Sound on lock/unlock"



Unlocking is confirmed with two sound signals, locking is confirmed with one sound signal.

Folding mirrors in automatically

Automatic folding of the side mirrors can be adjusted on the Interaction Unit.

Go through the menu as follows: Apps menu / "Vehicle" / "Doors and windows" / "Lock" / "Doors and windows" / "Fold mirrors on lock/unlock".

Cargo area

Cargo area button on vehicle key

It is possible to choose where to assign the cargo area button on the vehicle key.

- Go through the menu as follows:
Apps menu / "Vehicle" / "Doors and windows" / "Tailgate" / "Vehicle key" / "Tailgate button".
- Select the desired setting:
 - "Tailgate"
Depending on the equipment, the cargo area will be unlocked or opened.
 - "Tailgate and door(s)"
Depending on the equipment, the trunk will be unlocked or opened and the doors are unlocked.
 - "Tailgate"
The vehicle must be unlocked before the cargo area can be operated with the vehicle key.
 - "Lock tailgate button"
Operating the cargo area with the vehicle key is disabled.

Window

Opening windows automatically

- Go through the menu as follows: Apps menu / "Vehicle" / "Doors and windows".
- Select the desired setting.

If this setting is enabled, the driver's window opens automatically as soon as the vehicle reaches the saved location.

The vehicle speed must be below 6 mph/10 km/h.

Alarm system

Principle

The alarm system issues a visual and acoustic signal when someone attempts to open the locked vehicle incorrectly.

General information

When the vehicle is locked, the vehicle alarm system reacts to the following changes:

- If a door, the hood, or the trunk is opened.
- If movement is detected inside the vehicle.
- If the vehicle has a different tilt, e.g., due to an attempt to steal a wheel or when towing.
- If the battery voltage is interrupted.
- If the diagnostic socket is used improperly.
- If the vehicle is locked when a device is connected to the diagnostic socket.

The alarm system signals these changes visually and acoustically:

- Acoustic alarm:

Depending on local regulations, the acoustic alarm may be suppressed.

- Optical alarm:
By flashing of the hazard warning system and headlights, where required.

Do not modify the system to ensure function of the alarm system.

Turning the alarm system on/off

The alarm system is activated or deactivated as soon as the vehicle is locked or unlocked.

If the MINI app is used to lock the vehicle from a distance, the alarm system will not turn on.

Opening the doors with the alarm system switched on

The alarm system is triggered when a door is opened if the door was unlocked using the integrated key in the door lock.

Opening the cargo area with the alarm system switched on

The cargo area can be opened even when the alarm system is switched on.

After closing the cargo area, the cargo area will be locked and monitored again. The hazard warning system flashes once during closing.

Panic mode

You can trigger the alarm system if you find yourself in a dangerous situation.

-  Press the button on the vehicle key and hold for at least 3 seconds.
- Briefly press the button on the vehicle key three times in succession.

To switch off the alarm: press any button.

Indicator light on the interior mirror

The indicator light on the interior mirror shows the status of the alarm system:



- The indicator light flashes briefly every 2 seconds:
The alarm system is switched on.
- The indicator light flashes for approx. 10 seconds, then flashes briefly every 2 seconds:
The interior motion sensor and tilt alarm sensor are not activated because the doors, hood, or tailgate are not closed correctly. Correctly closed access points are secured.
The interior motion sensor and tilt alarm sensor will turn on when all open access points are closed.
- The indicator light flashes even though all access points have been closed:
Alarm system error.
- The indicator light goes out after unlocking:
The vehicle has not been tampered with.
- The indicator light flashes after unlocking until drive-ready state is switched on, but no longer than approx. 5 minutes:
The alarm has been triggered.

Tilt alarm sensor

The tilt alarm sensor is part of the alarm system and monitors the vehicle's tilt.

The alarm system responds in situations such as attempts to steal a wheel or when the vehicle is towed.

Interior motion sensor

The interior motion sensor is part of the alarm system and monitors the vehicle interior.

The alarm system triggers when movement is detected inside the vehicle.

The windows must be closed for the system to function properly.

Avoiding unintentional alarms

General information

The tilt alarm sensor and interior motion sensor can trigger an alarm, although no unauthorized action occurred.

An unintentional alarm can be triggered in the following situations:

- In car washes.
- In duplex garages.
- During transport on trains carrying vehicles, at sea or on a trailer.
- With animals in the vehicle.
- When the vehicle is locked after start of refueling.

The tilt alarm sensor and the interior motion sensor can be switched off in such situations.

Switching off the tilt alarm sensor and interior motion sensor

The tilt alarm sensor and interior motion sensor can be turned off as follows:

-  As soon as the vehicle is locked, press the lock button on the vehicle key within 30 seconds.

The indicator light illuminates for approx. 2 seconds and then continues to flash.

- After standby state turns off, an option to deactivate the interior motion sensor and tilt alarm sensor appears on the Interaction Unit.

The tilt alarm sensor and interior motion sensor are deactivated until the vehicle is locked again.

Ending the alarm

To stop the alarm, unlock the vehicle.

If the vehicle is unlocked with the integrated key, the drive-ready state must subsequently be turned on via the emergency detection of the vehicle key.

Window

Principle

The windows can be operated as follows:

- With the vehicle key.
- Using the door handle.
- Using the switches inside the vehicle.

Safety information

Warning

When operating the windows, body parts and objects can be jammed. There is a risk of injury or risk of damage to property. Make sure that the travel path of the windows is clear while opening and closing.



With the vehicle key

Opening windows with the vehicle key



To open the windows with the vehicle key, unlock the vehicle, then press and hold the unlock button on the vehicle key.

The windows open for as long as the button on the vehicle key is pressed.

Closing windows with the vehicle key



With Comfort Access: To close the windows with the vehicle key, lock the vehicle, then press and hold the lock button on the vehicle key.

The windows close for as long as the button on the vehicle key is pressed.

Depending on the vehicle equipment, exterior mirrors are folded in unless they were folded in while locking. The exterior mirrors are not folded in when the hazard warning flashers are switched on.

On the door handle

Principle

The windows can be closed using the door handle without operating the vehicle key.

The vehicle key is automatically detected near the vehicle.

General information

The function is available with Comfort Access.

Depending on national-market version, the windows can also be closed via the door handle using a compatible smartphone and digital key.

Additional information:

MINI Digital Key, refer to page [80](#).

Functional requirements

To close the windows using the door handle, the following functional requirements must be met:

- Carry the vehicle key with you, e.g., in your pants pocket.
- Bluetooth must be activated on the smartphone to close the window(s) using the digital key.

Closing windows with the door handle

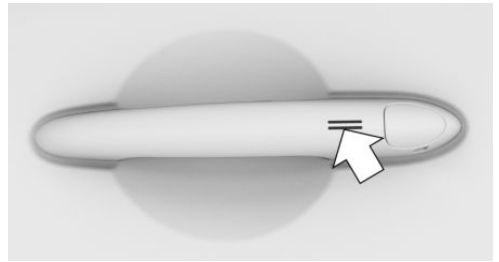

To close a window using the door handle, touch the grooved surface on the closed driver's door handle with your finger and hold it there without gripping the door handle.

In addition to locking, the windows and glass sunroof will be closed.

Depending on the vehicle equipment, exterior mirrors are folded in unless they were folded in during locking. The exterior mirrors are not folded in when the hazard warning flashers are switched on.

Inside the vehicle

Overview

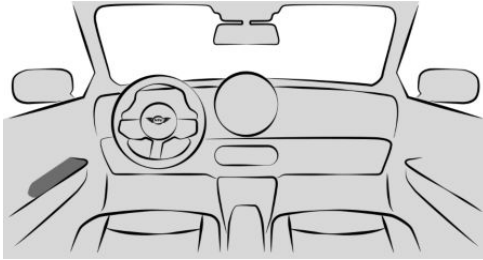

The power window switches are located on the doors.

Functional requirements

To close the windows inside the vehicle, the following functional requirements must be met:

- Standby state is switched on.
- Drive-ready state is switched on.

The vehicle key or digital key must be inside the vehicle.

Opening windows

To open the windows, proceed as follows:

-  On the door, press the power window switch to the resistance point.

The window opens while the switch is being held.

-  On the door, pull the power window switch past the resistance point.

The window opens automatically. Pressing the switch again stops the motion.

Closing the windows

To close the windows, proceed as follows:

-  On the door, pull the power window switch to the resistance point.

The window closes while the switch is being held.

-  On the door, pull the power window switch past the resistance point.

The window closes automatically. Pulling again stops the motion.

Anti-trap mechanism

Principle

The anti-trap mechanism prevents objects or body parts becoming jammed between the door frame and window while a window is being closed.

General information

If resistance or blockage is detected while a window is being closed, the closing will be interrupted.

Safety information

Warning

Accessories on the windows such as antennas can impact anti-trap mechanism. There is a risk of injury. Do not install accessories in the area of movement of the windows.



Closing without the anti-trap mechanism

In case of danger from the outside or if icing might prevent normal closing, proceed as follows:

1.  On the door, pull the power window switch past the resistance point and hold it.

The window closes with limited anti-trap mechanism. If the closing force exceeds a specific threshold, closing is interrupted.

2.  On the door, pull the power window switch past the resistance point again within approx. 4 seconds and hold it there.

The window closes without the anti-trap mechanism.

Opening windows automatically

If the driver's window is frequently opened in the same location, the window can be set to open automatically. This is useful if you frequently use the same parking garage, for example.

Additional information:

Settings, refer to page 84.

Glass sunroof

Safety information

Warning

Body parts can be jammed when operating the glass sunroof. There is a risk of injury. Make sure that the area of movement of the glass sunroof is clear during opening and closing.

With the vehicle key

Opening glass sunroof



To open the glass sunroof, unlock the vehicle, then press and hold the unlock button on the vehicle key.

The glass sunroof opens for as long as the button on the vehicle key is pressed.

Closing glass sunroof



With Comfort Access: To close the glass sunroof, lock the vehicle, then press and hold the lock button on the vehicle key when close to the vehicle.

The glass sunroof closes for as long as the button on the vehicle key is pressed.

Depending on the vehicle equipment, exterior mirrors are folded in unless they were folded in while locking. The exterior mirrors are not folded in when the hazard warning flashers are switched on.

On the door handle

Principle

The glass sunroof can be closed using the door handle without operating the vehicle key.

The vehicle key is automatically detected near the vehicle.

General information

The function is available with Comfort Access.

Depending on the country, the glass sunroof can also be closed via the door handle using compatible smartphones and your digital key.

Additional information:

MINI Digital Key, refer to page 80.

Functional requirements

To close the glass sunroof using the door handle, the following functional requirements must be met:

- Carry the vehicle key with you, e.g., in your pants pocket.
- Bluetooth must be activated on the smartphone to close the glass sunroof using the Digital Key.

Closing glass sunroof

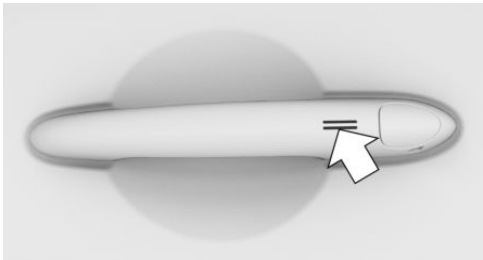

To close the glass sunroof using the driver's door handle, touch the grooved surface on the driver's door handle with your finger and hold it there without reaching into the recessed grip.

In addition to locking, the windows and glass sunroof will be closed.

Depending on the vehicle equipment, exterior mirrors are folded in unless they were

folded in while locking. The exterior mirrors are not folded in when the hazard warning flashers are switched on.

Inside the vehicle

Overview



The glass sunroof switch is located in the headliner.

Functional requirements

The glass sunroof can be operated when the following prerequisites are met:

- Standby state is switched on.
- Drive-ready state is switched on.

The vehicle key must be inside the vehicle.

Lifting/closing glass sunroof



To raise/close the glass sunroof, briefly press the glass sunroof switch in the headliner upward.

- The closed glass sunroof tilts.
- The opened glass sunroof closes until it is in the tilted position.
- The tilted glass sunroof closes.

Opening/closing the glass sunroof

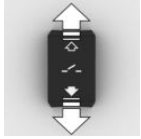

- To open/close the glass sunroof, in the headliner, press the glass sunroof switch backward, to the resistance point, and hold it there.

The glass sunroof will open for as long as the switch is held.

- Push the switch forward to the resistance point and hold.
The glass sunroof closes while the switch is being held.
- Push the switch back past the resistance point.
The glass sunroof opens automatically.
Pressing the switch again stops its movement.
- Push the switch forward past the resistance point.
The glass sunroof closes automatically.
Pressing the switch again stops its movement.

Comfort position

On some models, there is less wind noise inside the vehicle when the glass sunroof is not fully open. In these models, the automatic function initially only opens the glass sunroof up to this comfort position.

Operating the glass sunroof switch in the headliner again opens the glass sunroof completely.

Opening/closing the sun protection

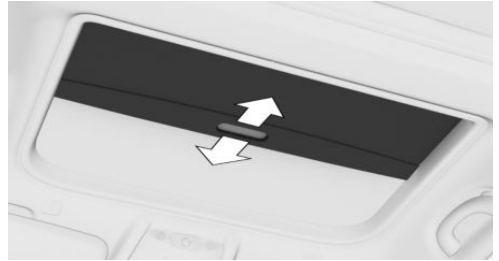

To open/close the sun protection, slide the sun protection to the desired position using the handle.

Anti-trap mechanism

Principle

The anti-trap mechanism prevents objects or body parts from becoming jammed between the roof frame and glass sunroof while the glass sunroof is closing.

If resistance or a blockage is detected while the glass sunroof is closing, it will stop closing when the roof reaches the half-open position or when closing from the tilted position.

Closing from the open position without the anti-trap mechanism

In case of danger from the outside or icing might prevent normal closing, proceed as follows:

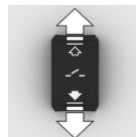

1. Close all doors.
2. Turn on drive-ready state or stop the vehicle if moving.



- in the headliner, press the glass sunroof switch forward, past the resistance point, and hold it there.

The glass sunroof closes with limited anti-trap mechanism. If the closing force exceeds a certain threshold, closing is stopped.

- Push the switch forward again past the resistance point and hold, until the glass sunroof closes without the anti-trap mechanism. Make sure that the closing path is clear.

Closing from the lifted position without the anti-trap mechanism

In case of danger from the outside or if icing might prevent normal closing, proceed as follows:

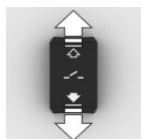

- Close all doors.
- Turn on drive-ready state or stop the vehicle if moving.
- in the headliner, press the glass sunroof switch forward, past the resistance point, and hold it there.

Initializing after a power interruption

General information

After a power interruption during the opening or closing process, the glass sunroof can only be operated to a limited extent. Initializing the system can help in this case.

The system can be initialized under the following conditions:

- The vehicle is parked in a horizontal position.
- The vehicle will not be moved until the initialization is completed.
- The drive-ready state is established.
- The outside temperature is above 41 °F/5 °C.

During initialization, the glass sunroof closes without the anti-trap mechanism. Make sure that the closing path is clear.

Initializing the system



To initialize the system, in the headliner, press the glass sunroof switch upward and hold it until initialization is complete:

Initialization begins within 15 seconds.

- If the glass sunroof is closed, it opens then closes again.
- If the glass sunroof is open, it first closes, then opens and closes again.

Initialization is complete once the glass sunroof has opened then closed again.



Seats, mirrors and steering wheel

Vehicle features and options

This chapter describes model-specific equipment, systems, and functions that are currently available, or may become available in the future, even if they are not present in the vehicle.

Additional information:

Vehicle equipment, refer to page 8.

Sitting safely

An ideal seat position that meets the needs of the occupants can make a vital contribution to relaxed, fatigue-free driving.

In the event of an accident, having the correct seat position and using the protection systems correctly both play an important role. Follow the information in the following chapters.

Additional information:

- Seats, refer to page 94.
- Seat belts, refer to page 99.
- Head restraints, refer to page 101.
- Airbags, refer to page 161.

Front seats

Safety information

Warning

Seat setting while driving can lead to unexpected movements of the seat. Vehicle control could be lost. There is a risk of accident, injury, or property damage. Only

adjust the seat on the driver's side when the vehicle is stationary.

Warning

With a backrest inclined too far to the rear, the protective effect of the seat belt can no longer be ensured. There is a risk of sliding under the seat belt in an accident. There is a risk of injury or danger to life. Adjust the seat prior to starting the trip. Adjust the backrest so that it is in the most upright position as possible and do not adjust again while driving.

Warning

There is a danger of jamming when moving the seats. There is a risk of injury or risk of damage to property. Make sure that the travel path of the seat is clear prior to any adjustment.

Manually adjustable seats

Principle

Manually adjustable seats are operated using the levers on the seat.

Overview



The levers for setting the seats are located on the front seats.

Setting the longitudinal direction

Warning

If a seat is not locked, it may move unexpectedly while driving. Vehicle control could be lost. There is a risk of accident, injury, or property damage. After adjusting, move the seat forward or back slightly, making sure the seat engages properly.



To adjust the longitudinal direction, pull up the longitudinal direction lever at the front of the seat and push the seat in the desired direction.

Adjusting the height

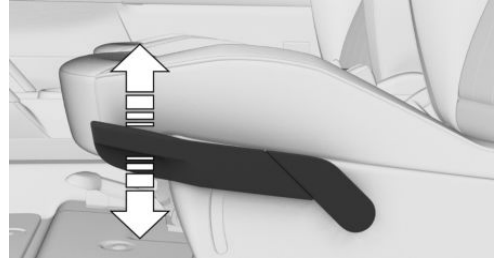

To adjust the height: On the side of the seat, push the seat height lever up or down as many times as necessary for the seat to reach the desired height.

Adjusting backrest tilt

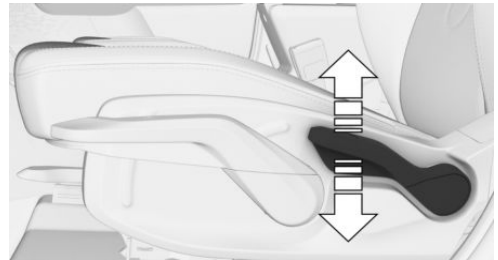

To adjust the backrest tilt, pull the backrest tilt lever on the side of the seat and tighten or loosen the backrest as required.

Electrically adjustable seats

Principle

Electrically adjustable seats are operated using the switches on the seat.

The current seat position can be stored using the memory function.

Additional information:

Memory function, refer to page [106](#).

Overview



The switches for setting the seats are located on the front seats.

Adjusting seat tilt

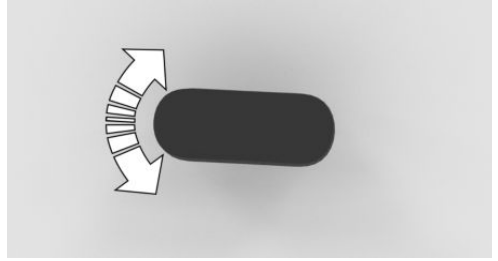

To adjust the seat tilt, flip the seat tilt switch up or down.

Setting the longitudinal direction

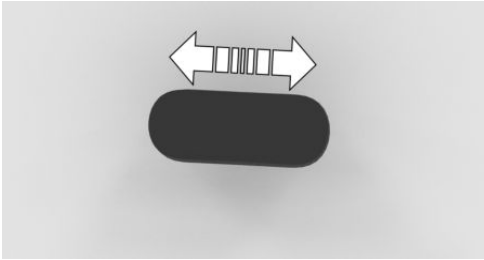

To adjust the seat in the longitudinal direction, press the longitudinal direction switch forward or backward.

Adjusting backrest tilt

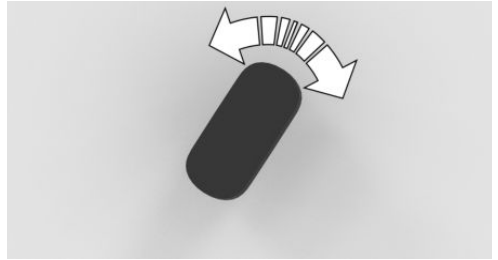

To adjust the backrest tilt, flip the backrest tilt switch forward or backward.

Adjusting the height

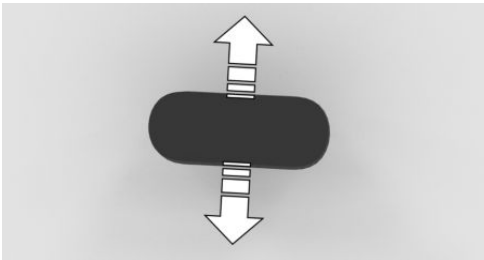

To adjust the seat height, press the seat height switch up or down.

Adjusting the seat position automatically

Principle

The seat setting for the driver's seat is saved to the active MINI ID or driver profile. If the MINI ID or driver profile is reactivated later, the saved position is applied automatically.

Activate/deactivate the function

To activate/deactivate the automatic seat adjuster, proceed as follows:

1. Go through the menu as follows: Apps menu / "Vehicle" / "Seat comfort" /

"Driver" / "Automatically use seat position".

2. Select the desired setting.

Lumbar support

Principle

The curvature of the seat backrest can be adjusted in a way that it supports the lumbar region of the spine. The lower back and the spine are supported for upright sitting position.

Adjusting the lumbar support

To adjust the lumbar support, proceed as follows:



- To increase or decrease the bulge, press the lumbar support button forward or backward.
- To move the bulge up or down, press the lumbar support button up or down.

Functional limitation

The lumbar support cannot be adjusted at very high temperatures.

Seat massage

Principle

Using the seat massage helps relax the muscles and improve circulation in the lumbar region, which, in turn, helps prevent fatigue.

Seat massage menu



To go directly to the Seat Massage menu on the Interaction Unit, press the seat massage button on the seat.

Turning the seat massage on/off

To turn the seat massage on/off, proceed as follows:

1. Go through the menu as follows: Apps menu / "Vehicle" / "Seat comfort".
2. Select the desired seat.
3. "Seat massage"
4. Select the desired setting, as necessary.

The seat massage is stopped when the lumbar support is operated.

Entering the rear

Safety information

Warning

There is a danger of jamming when moving the seats. There is a risk of injury or risk of damage to property. Make sure that the travel path of the seat is clear prior to any adjustment.

Warning

Unexpected movements of the rear seat backrest while driving may occur if the rear seat backrest is unlocked. Vehicle control could be lost. There is a risk of accident, injury, or property damage. Fold back and lock the backrests before driving. Make sure the backrest engages correctly by slightly moving forward and back.

Manual longitudinal setting

Fold the seat backrest forward

To fold down the backrest and manually adjust the longitudinal setting, proceed as follows:

1. Pull lever to the stop.

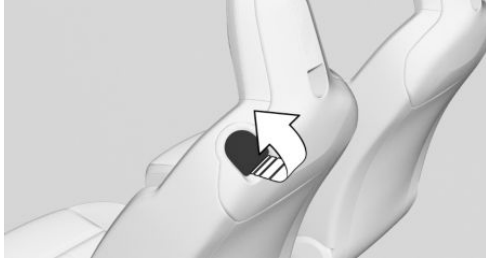

2. Fold the backrest forward.
3. Push the seat forward.

Push the seat backrest rearward

1. Push the seat back into its initial position.
2. Fold back the backrest to lock the seat.

Electric longitudinal setting

Fold the seat backrest forward

To fold down the backrest and use the electric adjuster for the longitudinal setting, proceed as follows:

1. Pull lever to the stop.

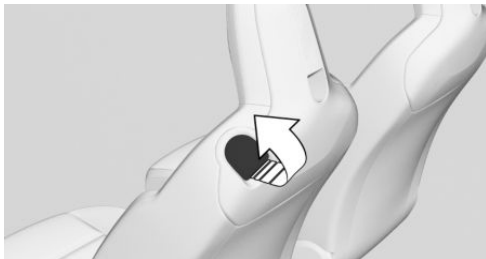

2. Fold the backrest forward.

To make the entry to the rear easier, the seat will automatically move to the most forward position.

The process will be terminated when the switch for the forward/back direction adjustment is pressed or the backrest is reclined.

Push the seat backrest rearward

Fold back the backrest and lock it.

The seat moves automatically to the last seat position that was stored.

Calibrating the front seats

Principle

A Check Control message is displayed on the Interaction Unit when the electric seat adjuster is not working properly.

To restore the accuracy of the electric seat setting, the front seats must be calibrated.

Safety information

Warning

There is a danger of jamming when moving the seats. There is a risk of injury or risk of damage to property. Make sure that the travel path of the seat is clear prior to any adjustment.

Calibrating the front seat

1. To calibrate the front seat, press the longitudinal direction switch on the seat forward for approx. 2 seconds until the seat stops.
2. Repeat step 1 until the seat stops then moves slightly forward.

3. Press the switch forward for approx. 2 seconds again until the seat stops.
4. Repeat step 3 until the seat stops then moves slightly backward.

As soon as the message on the Interaction Unit disappears, the calibration is complete. If the message remains active, repeat the calibration.

If the message is still shown after repeated calibration, have the vehicle checked by an authorized service center or another qualified service center or repair shop.

Comfort exit

Principle

The comfort exit setting makes it easier to get in/out of the vehicle by automatically adjusting the seat position and moving the seat back.

Activating/deactivating comfort exit

1. Go through the menu as follows: Apps menu / "Vehicle" / "Seat comfort" / "Comfort exit".
2. Select the desired setting.

Seat belts

Principle

The vehicle is fitted with four seat belts to ensure occupant safety. However, they can only offer protection when adjusted correctly.

Always make sure that seat belts are being worn by the occupants before driving off. The airbags supplement the seat belts as an additional safety device. The airbags do not replace seat belts.

All seat belt anchorage points are designed to achieve the best possible protective effect for the seat belts when used properly and with the correct seat settings.

Additional information:

Notes on sitting safely, refer to page 94.

Safety information

Warning

Use of a seat belt to buckle more than one person will potentially defeat the ability of the seat belt to serve its protective function. There is a risk of injury or danger to life. Do not strap in more than one person per single seat belt. Infants and children are not allowed on an occupant's lap, and must be transported and secured in designated child restraint systems.

Warning

The protective effect of safety gear, including seat belts, can be limited or lost when seat belts are fastened incorrectly. An incorrectly fastened seat belt can cause additional injuries, for instance in the event of an accident, braking or evasive maneuvers. There is a risk of injury or danger to life. Make sure that all occupants are wearing seat belts correctly.

Warning

The protective effect of safety gear, including seat belts, may not be fully operational or fail in the following situations:

- The seat belts or seat belt buckles are damaged, soiled, or changed in any other way.
- Seat belt tensioners or seat belt winders were modified.

Seat belts can be imperceptibly damaged in the event of an accident. There is a risk of injury or danger to life. Keep clean and do not modify: seat belts, seat belt buckles, seat belt tensioners, seat belt winders, and seat belt anchors. After an accident, have the seat belts checked by an authorized service center or another qualified service center or repair shop.

Correct use of seat belts

To use the seat belts correctly, note the following:

- Wear the seat belt tight to your body over your lap and shoulders, without twisting it.
- Wear the seat belt deep on your hips over your lap. The seat belt must not press on your stomach.
- Do not rub the seat belt against sharp edges, or guide it or jam it in across hard or fragile objects.
- Avoid thick clothing.
- Re-tighten the seat belt frequently upward around your upper body area.

Buckling the seat belt

1. To fasten the seat belt, guide the seat belt slowly over the shoulder and hip.
2. Insert the buckle tongue into the seat belt buckle. The seat belt buckle must engage audibly.

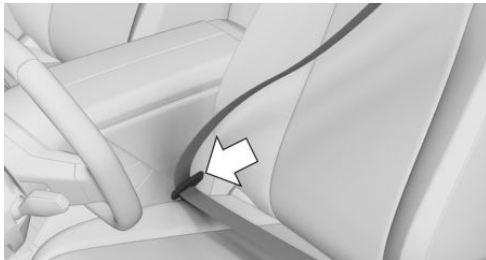

To ease accessibility to the seat belt buckle, an adjustable slider is available on the belt to help position the buckle when not in use.

Unbuckling the seat belt

1. To open the seat belt, hold the seat belt firmly.
2. Press the red button on the seat belt buckle.
3. Guide the seat belt back into the seat belt winder.

Seat belt reminder

Principle

The Seat Belt Warning warns the driver if the seat belts are not fastened.

General information





The seat belt reminder becomes active in the following situations:

- When the seat belt on the driver's side or on the passenger's side is not fastened.
- When the seat belt is unfastened while driving.
- When objects are lying on a seat.

Interaction Unit view

The indicator light on the Interaction Unit illuminates when drive-ready state is turned on and when the Seat Belt Warning is on.

A Check Control message is displayed where applicable. Check whether the seat belt has been fastened correctly.

Icon	Meaning
	Seat belt on the driver's seat is not buckled.
	Seat belt on the passenger seat or another seat in the vehicle is not buckled.
	Seat belt is buckled on the corresponding seat.
	Seat belt is not buckled on the corresponding seat.

Rear Occupant Alert

Principle

At the end of the drive, the Rear Occupant Alert informs the driver that occupants may be present on the rear seats.

General information

If a door with access to the rear seat row is operated within 30 minutes before starting a drive, a notice appears on the control display and a signal tone sounds at the end of the drive.

If the drive is continued within 30 minutes, the notice is displayed again after the drive is complete.

Activating/deactivating the Rear Occupant Alert

To activate or deactivate the Rear Occupant Alert, proceed as follows:

1. Go through the menu as follows: Apps menu / "Vehicle" / "Rear Occupant Alert".
2. Select the desired setting.

Front head restraints

Safety information

Warning

Removal or incorrect adjustment of head restraints can cause injuries in the head and neck area. There is a risk of injury.

- Before driving, install the removed head restraints on the occupied seats.
- Adjust the head restraint so its center supports the back of the head at as close to eye level as possible.
- Adjust the distance so that the head restraint is as close as possible to the back of the head. Adjust the distance via the backrest tilt as needed.
- For manually adjustable head restraints: After adjusting, make sure that the head restraint is correctly engaged.

Warning

Body parts can be jammed when moving the head restraint. There is a risk of injury. Make sure that the area of movement is clear when moving the head restraint.

Warning

Objects on the head restraint reduce the protective effect in the head and neck area. There is a risk of injury.

- Do not use seat or head restraint covers.
- Do not hang objects, for instance clothes hangers, directly on the head restraint.



- Only use accessories that have been determined to be safe for attachment to a head restraint.
- Do not use any accessories, for instance pillows, while driving.

Adjusting the height

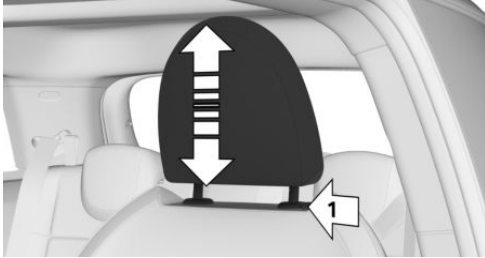

- To raise the height of the head restraint, push the head restraint upward.
- To lower the height of the head restraint, press the release button on the backrest, arrow 1, then push the head restraint downward.

John Cooper Works sport seat: Adjusting the height

The height of the head restraints cannot be set.

Adjusting the distance

The backrest tilt is used to set the distance between the head restraint and the back of the seat occupant's head.

Adjust the distance so that the head restraint is as close as possible to the back of the head.

Removing/attaching head restraints

Only remove the head restraint if no one will be sitting in the seat in question.

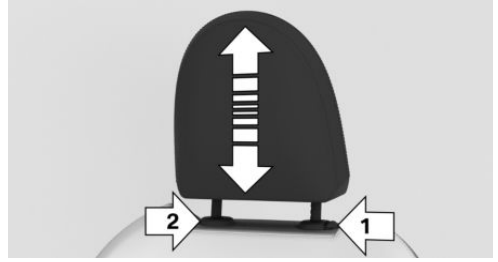

1. Raise the head restraint to the resistance point.
2. Press the release buttons on the backrest, arrows 1 and 2, then pull the head restraint completely out.

Proceed in the reverse order to install the head restraint.

John Cooper Works sport seat: Removing head restraints

The head restraints cannot be removed.

Rear head restraints

Safety information

Warning

Removal or incorrect adjustment of head restraints can cause injuries in the head and neck area. There is a risk of injury.

- Before driving, install the removed head restraints on the occupied seats.
- Adjust the head restraint so its center supports the back of the head at as close to eye level as possible.

- Adjust the distance so that the head restraint is as close as possible to the back of the head. Adjust the distance via the backrest tilt as needed.
- For manually adjustable head restraints: After adjusting, make sure that the head restraint is correctly engaged.

Warning

Body parts can be jammed when moving the head restraint. There is a risk of injury. Make sure that the area of movement is clear when moving the head restraint.

Warning

Objects on the head restraint reduce the protective effect in the head and neck area. There is a risk of injury.

- Do not use seat or head restraint covers.
- Do not hang objects, for instance clothes hangers, directly on the head restraint.
- Only use accessories that have been determined to be safe for attachment to a head restraint.
- Do not use any accessories, for instance pillows, while driving.

Adjusting the height

To improve the view of the rear, the rear head restraints can be lowered completely. Set seat to the lowest position only if no one will be sitting in the seat.

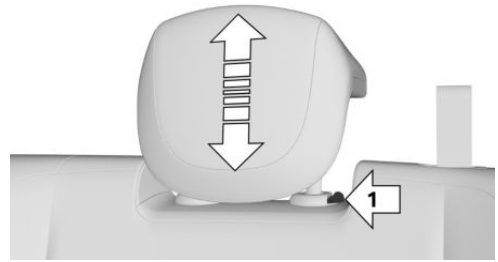

- To raise the head restraint, push the head restraint upward.
- To lower the head restraint, press the release button on the backrest, arrow 1, then push the head restraint downward.

Removing/attaching head restraints

Only remove the head restraint if no one will be sitting in the seat in question.

1. Fold down the corresponding rear seat backrest.
To fold down the rear seat backrest, follow the steps for enlarging the cargo area.
2. Raise the head restraint to the resistance point.
3. Press the release button on the backrest, arrow 1, then pull the head restraint completely out.

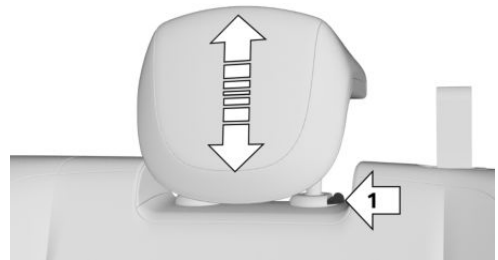

Additional information:

Enlarging the cargo area, refer to page [270](#).

Proceed in the reverse order to install the head restraint.

Exterior mirrors

Principle

The front passenger's side exterior mirror is more curved than the driver's side mirror.

Exterior mirror settings are saved to the active MINI ID or driver profile. If the MINI ID or driver profile is reactivated later, the saved position is brought up automatically.

Depending on vehicle equipment, the driver's side exterior mirror also dims automatically. Photocells in the interior mirror are used to control this.

Depending on vehicle equipment, both exterior mirrors are heated automatically as necessary and when drive-ready state is on.

General information

The current exterior mirror adjustment can be stored using the memory function.





Safety information

Warning



Objects in the mirror are closer than they appear. The distance to the road users behind could be incorrectly estimated, for instance while changing lanes. There is a risk of accident, injury, or property damage. Estimate the distance to the traffic behind by looking over your shoulder.

Overview



Icon	Meaning
	Fold the exterior mirror in and out.
	Adjust the exterior mirrors.
	Select left exterior mirror, Automatic Curb Monitor.
	Select right exterior mirror.

Selecting the exterior mirror

-  To select the left exterior mirror, press the corresponding button on the driver's door. The LED illuminates.
-  To select the right exterior mirror, press the corresponding button on the driver's door. The LED illuminates.

Adjusting the exterior mirrors

-  On the driver's door, press the button for adjusting the exterior mirrors.

The selected exterior mirror moves along with the button movement.



Malfuction

In case of an electrical malfunction, adjust the exterior mirror by pressing on the edges of the mirror glass.

Folding in/folding out the exterior mirrors

NOTICE

Depending on the vehicle width, the vehicle can be damaged in car washes. There is a risk of damage to property. Before washing, fold in the mirrors by hand or with the button.



To fold the exterior mirrors in/out, press the button for folding the exterior mirrors in/out on the driver's door.

Folding is possible up to a speed of approx. 15 mph/20 km/h.

Folding the exterior mirrors in and out is helpful in the following situations:

- In car washes.
- On narrow roads.

Exterior mirrors that were folded in are folded out automatically at a speed of approx. 25 mph/40 km/h.

Automatic dimming

The exterior mirror on the driver's side is automatically dimmed. Photocells in the interior mirror are used to control this.

Automatic Curb Monitor

Principle

Depending on vehicle equipment, the mirror glass on the front passenger's side is tilted downward when reverse gear is engaged. This improves your view of the curb

and other low-lying obstacles when parking, for instance.

Activating the Automatic Curb Monitor

1.  To activate the Automatic Curb Monitor, press the exterior mirror button on the driver's door. The LED illuminates.
2. Engage selector lever position R.

Deactivating the Automatic Curb Monitor



To deactivate the Automatic Curb Monitor, press the exterior mirror button on the front passenger door. The LED illuminates and the LED of the driver's side outside mirror goes out.

Interior mirror, manually dimmable

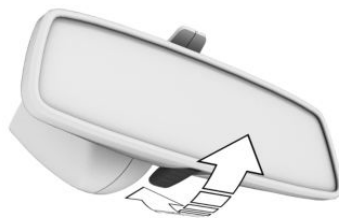

To reduce blinding glare from the interior mirror, tilt the lever forward on the manually dimming interior mirror.

Interior mirror, automatic dimming feature

Principle

The interior mirror is dimmed automatically.

Photocells in the mirror glass and on the rear of the mirror are used to control glare.

Overview



Functional requirements

To ensure that the auto dimming interior mirror works properly, note the following:

- Keep the photocells clean.
- Do not cover the area between the interior mirror and the windshield.

Steering wheel

Safety information

Warning

Steering wheel adjustments while driving can lead to unexpected steering wheel movements. Vehicle control could be lost. There is a risk of accident, injury, or property damage. Adjust the steering wheel while the vehicle is stationary only.

Manual steering wheel adjustment

The position of the steering wheel can be changed by manually adjusting the height and longitudinal direction.

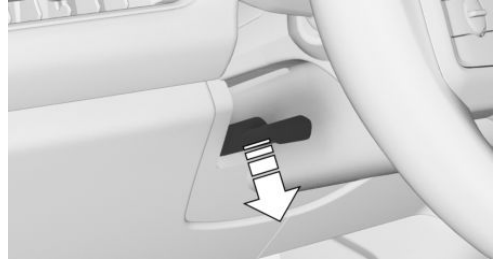

1. On the steering column, press the release lever all the way down.
2. Grip the steering wheel with both hands and move the steering wheel to the preferred height and angle to suit your seat position.
3. Fold the lever back up.

Memory function

Principle

The following settings can be stored and, if necessary, retrieved using the memory function:

- Seat position.
- Exterior mirror adjustment.
- Depending on the equipment: height of the Head-up display.

General information

Two memory locations with different settings can be set for each driver profile.

The settings for the lumbar support will not be stored.

Safety information

Warning

Using the memory function while driving can lead to unexpected seat or steering wheel movements. Vehicle control could be lost. There is a risk of accident, injury, or property damage. Only retrieve the memory function when the vehicle is stationary.

Warning

There is a danger of jamming when moving the seats. There is a risk of injury or risk of damage to property. Make sure that the travel path of the seat is clear prior to any adjustment.

Overview



The memory buttons are located on the front seats.

Storing settings

To save settings to memory using the buttons, proceed as follows:

1. Set the desired position.
2.  Press the SET button on the seat. The LED illuminates.
3. Press memory button 1 or 2 while the LED is illuminated. A successful save is indicated by a signal tone.

To save settings to memory using the Interaction Unit, proceed as follows:

1. Go through the menu as follows: Apps menu / "Vehicle" / "Seat comfort".
2. Select the desired seat.
3. "Save seat position"

Calling up settings

To access settings saved to memory using the buttons, proceed as follows:

Press the desired memory button 1 or 2.

The stored position is called up.

The procedure stops when a seat setting switch or one of the memory buttons is pressed again.

The adjustment of the seat position on the driver's side is interrupted after a short time while driving.

To access settings from memory using the Interaction Unit, proceed as follows:

1. Go through the menu as follows: Apps menu / "Vehicle" / "Seat comfort".
2. Select the desired seat.
3. Select the desired seat position.



Seat climate control

Various climate control functions are available for the seats.

Additional information:

Climate control, refer to page [244](#).

Transporting children safely

Vehicle features and options

This chapter describes model-specific equipment, systems, and functions that are currently available, or may become available in the future, even if they are not present in the vehicle.

Additional information:

Vehicle equipment, refer to page 8.

The right place for children

Safety information

Warning

Unattended children or animals in the vehicle can cause the vehicle to move and endanger themselves and traffic, for example, due to the following actions:

- Establishing standby.
- Releasing the parking brake.
- Opening and closing the doors or windows.
- Engaging selector lever position N.
- Using vehicle equipment.

There is a risk of accident, injury, or property damage. Do not leave children or animals unattended in the vehicle. Take the vehicle key with you when exiting and lock the vehicle.

Warning

A hot vehicle may result in death to persons, especially children, or animals. There is a risk of injury or danger to life. Do not leave people, especially children, or animals unattended in the vehicle.

Warning

Exposure to intense sunlight can cause child restraint systems and their components to become very hot. Persons may sustain burn injuries when touching the hot components. There is a risk of injury. Do not expose the child restraint system to direct sunlight or cover where necessary. If necessary, let the child restraint system cool down before transporting a child. Do not leave children unattended in the vehicle.

Children in the rear seat

General information

Accident research shows that the safest place for children is in the rear seat.

Children younger than 13 years of age or shorter than 5 ft/150 cm should be transported in the rear seat in suitable child restraint systems designed for the age, weight and size of the child. Children 13 years of age or older must wear a seat belt as soon as a suitable child restraint system can no longer be used due to their age, weight, or size.



Safety information

Warning

The seat belt cannot be fastened correctly on children shorter than 5 ft/150 cm without suitable additional child restraint systems. The protective effect of safety gear, including seat belts, can be limited or lost when seat belts are fastened incorrectly. An incorrectly fastened seat belt can cause additional injuries, for instance in the event of an accident, braking or evasive maneuvers. There is a risk of injury or danger to life. Secure children shorter than 5 ft/150 cm using suitable child restraint systems.

Children on the front passenger seat

General information

When using a child restraint system on the front passenger seat, make sure that the front passenger airbag is deactivated.

Additional information:

Automatic deactivation of front passenger airbag, refer to page 163.

Safety information

Warning

Active front passenger airbags can injure a child in a child restraint system when the airbags are deployed. There is a risk of injury. Make sure that the front passenger airbags are deactivated and that the PASSENGER AIRBAG OFF indicator light illuminates.

Installing child restraint systems

General information

When selecting, installing, and using child restraint systems, pay close attention to the operating and safety instructions provided by the child restraint system manufacturer.

Safety information

Warning

The protective effect of child restraint systems and their fastening systems which have been damaged or exposed to an accident can be limited or lost. A child cannot be properly restrained in the event of an accident, braking or evasive maneuvers. There is a risk of injury or danger to life.

Do not use child restraint systems which have been damaged or exposed to an accident.

If attachment systems have been damaged or strained by an accident, have them checked and replaced by an authorized service center or another qualified service center or repair shop.

Warning

The stability of the child restraint system is limited or compromised with incorrect seat setting or improper installation of the child seat. There is a risk of injury or danger to life. Make sure that the child restraint system fits securely against the backrest. If possible, adjust the backrest tilt for all affected backrests and correctly adjust the seats. Make sure that seats and backrests are securely engaged or locked. If possible and necessary, adjust

the height of the head restraints or remove them.

Before installation

Before installing child restraint systems, ensure that the rear seat backrests are locked.

Move the rear seats into the rearmost position to facilitate installation of the child restraint system.

On the front passenger seat

Deactivating the airbag

Warning

Active front passenger airbags can injure a child in a child restraint system when the airbags are deployed. There is a risk of injury. Make sure that the front passenger airbags are deactivated and that the PASSENGER AIRBAG OFF indicator light illuminates.

After mounting a child restraint system on the front passenger seat, make sure that the front passenger airbag is deactivated.

Additional information:

Automatic deactivation of front passenger airbag, refer to page 163.

Seat position and height

After installing a child restraint system, move the front passenger seat as far back as it will go and, if possible, to the highest position. This seat position and height ensure the best possible position for the belt and offers optimal protection in the event of an accident.

After mounting a universal child restraint system, adjust the backrest tilt so that the seat belt sits properly.

If the upper attachment point of the seat belt is located in front of the seat belt guide of the child seat, move the front passenger seat carefully forward until the best possible seat belt guide position is reached.

Backrest width

Adjustable backrest width: Before installing a child restraint system on the front passenger seat, open the backrest width completely. Do not change the backrest width again and do not call up a memory position.

Child seat security

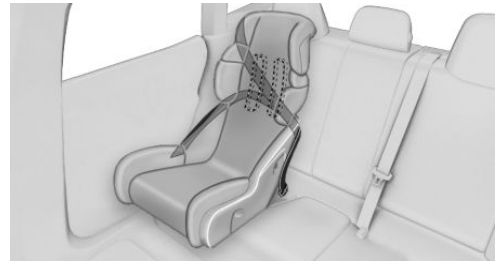

The seat belts in the rear and the front passenger seat belt can be permanently locked to fasten child restraint systems.

Locking the seat belt

1. Pull out the seat belt strap completely.
2. Secure the child restraint system with the seat belt.
3. Allow the seat belt strap to be pulled in, then pull it tight against the child restraint system. The seat belt is disabled.

Unlocking the seat belt

1. Open the seat belt buckle.
2. Remove the child restraint system.
3. Allow the seat belt strap to be pulled in completely.



LATCH child restraint system

Principle

LATCH child restraint systems establish a secure connection to the vehicle in combination with LATCH anchors.

General information

LATCH: Lower Anchors and Tether for Children.

When selecting, installing, and using LATCH child restraint systems, pay close attention to the operating and safety instructions provided by the child restraint system manufacturer.

Mounts for lower anchors

General information

The lower anchors may be used to attach the CRS to the vehicle seat up to a combined child and CRS weight of 65 lbs/30 kg when the child is restrained by the internal harnesses.

Safety information

Warning

If the lower anchors on child restraint system are not engaged correctly, the child restraint system will not be able to provide suitable protection. There is a risk of injury or danger to life. Make sure that the lower anchors are correctly engaged and that the child restraint system fits securely against the backrest.

Warning

The mounts for the lower anchors and attachment points of the child restraint system are intended for attaching child restraint systems only. If other objects are attached, the mounts or attachment points can be damaged. There is a risk of injury or risk of damage to property. Only attach child restraint systems at the corresponding mounts for the lower anchors or attachment points.

Position

Icon	Meaning
	<p>The corresponding icon shows the mounts for the lower LATCH anchors.</p> <p>Seats equipped with lower anchors are marked with a pair (2) of LATCH icons.</p> <p>For vehicles equipped with a middle seat:</p> <p>It is not recommended to use the inner lower anchors of standard outer LATCH positions to fasten a child restraint system on the middle seat. Use the vehicle seat belt instead for the middle seat.</p>

Before attaching child restraint systems

Before installing a child restraint system, pull the seat belt away from the child seat mountings.

Installing child restraint systems

To install the child restraint system in the vehicle, proceed as follows:

1. Mount the child restraint system in accordance with the instructions from the child seat manufacturer.
2. Make sure that the child restraint system anchors engage correctly on both sides in the lower seat mounts.

Child restraint systems with tether strap

General information

When attaching child restraint systems to the upper attachment points, observe the specifications and the operating and safety information of the child restraint system manufacturer.

Safety information

Warning

If the upper retaining strap is incorrectly used for the child restraint system, the protective effect is reduced. There is a risk of injury. Ensure that the upper retaining strap is guided to the upper attachment point without twisting and not over sharp edges.

Warning

If the rear seat backrest is not locked, the protective effect of the child restraint system is limited or nonexistent. In certain situations, for instance braking maneuvers or in case of an accident, the rear seat backrest can fold forward. There is a risk

of injury or danger to life. Make sure that the rear seat backrests are locked.

Warning

The mounts for the lower anchors and attachment points of the child restraint system are intended for attaching child restraint systems only. If other objects are attached, the mounts or attachment points can be damaged. There is a risk of injury or risk of damage to property. Only attach child restraint systems at the corresponding mounts for the lower anchors or attachment points.

Attachment points for upper retaining strap

Icon	Meaning
	The respective icon shows the attachment point for the upper retaining strap. Seats with an upper top tether are marked with this icon. It is located on the rear seat backrest, the rear shelf or the rear seat.



Routing the retaining strap

Rear seat

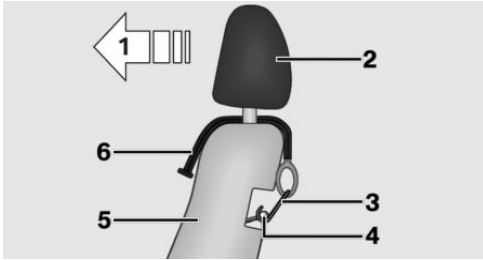

- 1 Driving direction
- 2 Head restraint
- 3 Hook for upper retaining strap
- 4 Attachment point
- 5 Seat backrest
- 6 Upper retaining strap

Attaching the upper retaining strap to the attachment point

Rear seat

To attach the upper strap to the attachment point, proceed as follows:

1. Raise the head restraint as needed.
2. Guide the upper strap between or along both sides of the head restraint mounts to the attachment point.
3. Attach the strap's hook to the attachment point.
4. Tighten the strap.

Driving

Vehicle features and options

This chapter describes model-specific equipment, systems, and functions that are currently available, or may become available in the future, even if they are not present in the vehicle.

Additional information:

Vehicle equipment, refer to page 8.

Start/Stop switch

Principle

The Start/Stop switch can be used to turn vehicle operating states on/off.

Overview



The Start/Stop switch is labeled **ENGINE** and located on the switch cluster.

Turning on the drive-ready state

Drive-ready state turns on when the Start/Stop switch is pushed while depressing the brake pedal. Pressing the Start/Stop switch again turns drive-ready state back off, and turns standby back on.

Additional information:

- Drive-ready state, refer to page 41.
- Standby state, refer to page 41.

Driving off

1. To turn drive-ready state on and drive off, turn the Start/Stop switch while also pressing the brake pedal.
2. Apply gear position.
3. Driving off.

When stopping

Selector lever position D, S, L, or R

On inclines, the system prevents rolling back against the set driving direction and provides drive-off support.

Driving off

To drive off after stopping while drive-ready state is on, press the accelerator pedal.

The parking brake is released automatically.

Depending on the vehicle load or driving situation, the vehicle may roll back slightly.

Auto Start/Stop function

Principle

The Auto Start/Stop function helps save fuel. The system switches off the engine during a stop, for instance in traffic jam or at traffic lights. Drive-ready state remains on even if the engine stops. The engine starts automatically for driving off.

The Auto Start/Stop function switches to standby whenever the engine is started using the Start/Stop button.

The function is activated at low speeds.



Engine stop

Functional requirements

The engine is switched off automatically when stopping under the following conditions:

- Selector lever is in selector lever position D.
- The brake pedal remains depressed while the vehicle is at a standstill, or the vehicle is held by Automatic Hold.
- The driver's seat belt is buckled, or the driver's door is closed.

Manual engine stop

If the engine was not switched off automatically when the vehicle stopped, the engine can be switched off manually:

- Depress the brake pedal forcefully again from the current pedal position.
- Engage selector lever position P.

When all functional preconditions are fulfilled, the engine switches off.

Automatic climate control with engine switched off

The air flow from the air conditioning system is reduced when the engine is switched off.

Interaction Unit view



READY

The READY indicator on the Interaction Unit shows that the Auto Start/Stop function is ready to start the engine automatically.

Functional limitations

The engine is not switched off automatically in the following situations:

- In case of a steep downhill grade.
- The brake pedal was not depressed hard enough.
- When the ambient temperature is high and automatic climate control is switched on.
- The vehicle interior has not yet been heated or cooled as desired.
- When window condensation is possible and automatic climate control is switched on.
- Engine or other parts are not at operating temperature.
- Engine cooling is required.
- Without Mild Hybrid technology: The wheels are at a sharp angle or the steering wheel is being turned.
- Vehicle battery is heavily discharged.
- At higher elevations.
- Hood is unlocked.
- For stop-and-go traffic.
- Selector lever position is S, L, or R.
- After reversing.

Starting the engine

Functional requirements

The engine starts automatically under the following preconditions:

- By releasing the brake pedal.
- When Automatic Hold is activated: step on the accelerator pedal.

Driving off with the Auto Start/Stop function

To drive off, accelerate normally after starting the engine.

Safety mode

After the engine switches off automatically, it will not start again automatically if any one of the following conditions are met:

- The driver's seat belt is unbuckled, or the driver's door is open.
- The hood has been unlocked.

Some indicator lights illuminate for a varied length of time.

The engine can only be started using the Start/Stop switch.

System limits

Even if driving off was not intended, the deactivated engine starts up automatically in the following situations:

- With excessive warming of the interior when cooling is turned on.
- With excessive cooling of the interior when heating is turned on.
- When window condensation is possible and automatic climate control is switched on.
- Without mild hybrid technology:
In case of a steering operation.
- When changing the selector lever position from D or P to R.
- If the vehicle battery is deeply discharged.
- When starting an oil level measurement.

Deactivating Auto Start/Stop manually

Principle

In certain driving situations, e.g., traffic jams, it may be helpful to deactivate Auto Start/Stop manually. The engine will then no longer switch off automatically.

If this function is deactivated while the engine is being stopped automatically, the engine will start.

Via the selector lever position or driving mode

The Auto Start/Stop function is deactivated by the following:

- When Go Kart Mode is selected using the MINI Modes switch.
- When the selector lever is used to select either LOW mode L or sport program S. This setting option depends on vehicle equipment.

Depending on vehicle equipment: Via Interaction Unit

Depending on vehicle equipment, the Auto Start/Stop function can be deactivated on the Interaction Unit.

1. To do so, go through the menu as follows: Apps menu / "Vehicle" / "Driving settings" / "Drivetrain and chassis" / "Activate Auto Start/Stop".
2. Select the desired setting.

Switching off the vehicle during an automatic engine stop

If the engine stops automatically, the vehicle can be parked safely, for example to leave it.

1. Turn the Start/Stop switch.
 - Drive-ready state is switched off.
 - Standby state is switched on.
 - Selector lever position P is engaged automatically.
2. Set the parking brake.

Automatic deactivation

In certain situations, the Auto Start/Stop function is deactivated automatically for



safety reasons, for instance if no driver is detected.

Malfunction

Auto Start/Stop no longer switches off the combustion engine automatically in the event of a malfunction. A Check Control message appears on the Interaction Unit. You may continue driving. Have the vehicle checked by an authorized service center or another qualified service center or repair shop.

Steptronic transmission

Principle

The Steptronic transmission is the vehicle's automatic transmission. Shift paddles allow you to shift manually as necessary.

Safety information

Warning

An unsecured vehicle can begin to move and possibly roll away. There is a risk of accident, injury, or property damage. Before leaving your vehicle, secure it against rolling away, e.g., by applying the parking brake.

Selector lever positions

Display

The engaged selector lever position is shown on the Interaction Unit and next to the selector lever, e.g., P.

Gear position D

In selector lever position D, all gears for forward travel are shifted automatically.

The vehicle drives off slowly when the brake pedal is released.

R reverse gear

To reverse, engage selector lever position R. Only engage reverse gear when the vehicle is stationary.

The vehicle drives off slowly when the brake pedal is released.

N Neutral

To push the vehicle or have it coast without using the drive system, engage selector lever position N, e.g., in car washes.

Parking brake P

General information

In position P, the drive is blocked by the transmission, e.g., to park the vehicle.

Only press parking brake button P when the vehicle is stationary.

Before leaving the vehicle, make sure to engage the parking brake. Otherwise, the vehicle may begin to move.

P is engaged automatically

The transmission lock engages automatically in situations like the following:

- After drive-ready state is turned off, if selector lever position R, M, or D/S is engaged.
- After standby state is switched off, if selector lever position N is engaged.
- If the driver's seat belt is unbuckled and the driver's door is opened while the vehicle is stationary and selector lever position R, M, or D/S is engaged.

Before leaving the vehicle, make sure to engage the parking brake. Otherwise, the vehicle may begin to move.

Additional information:

Parking brake, refer to page 126.

Engaging selector lever positions

General information

To prevent the vehicle from moving when a gear is engaged or when reversing, press and hold the brake pedal until the vehicle drives off.

Functional requirements

To engage a selector lever position, the following functional requirements must be met:

- To switch from selector lever position P to another selector lever position, drive-ready state must be on and the brake pedal must be pressed.
- Selection lever position P cannot be disengaged until all technical prerequisites are met.

Engaging a selector lever position

To engage selector lever positions, proceed as follows:

1. Fasten the driver's seat belt.
2. Push the selector lever in the desired direction, past the resistance point if necessary. The selector lever automatically returns to the center position when released.

With shift paddles: To switch between selector lever position D and S, tap the selector lever toward D/S.

Without shift paddles: To switch between selector lever position D and L, tap the selector lever toward D/L.

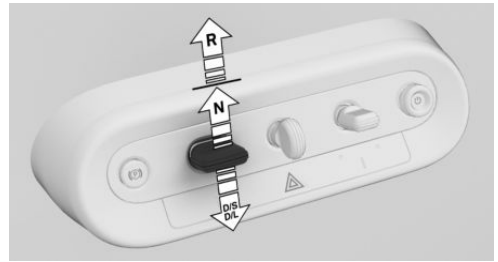

Engaging selector lever position P

Only push the parking brake button when the vehicle is stationary.



 To engage selector lever position P and the parking brake, press the parking brake button on the switch cluster.

The parking brake is applied and the transmission lock is engaged.

Rolling or pushing the vehicle

General information

In some situations, the vehicle is supposed to roll without its own drive for a short distance, for instance in a car wash or to be pushed.



Engaging selector lever position N

NOTICE

Selector lever position P is automatically engaged when standby state is switched off. The wheels are blocked. There is a risk of damage to property. Do not switch off standby if the vehicle is meant to coast, e.g., in a car wash.

To engage selector lever position N, proceed as follows:

1. Depress the brake pedal.
2. Switch on drive-ready state.
3. Engage selector lever position N.
4. Switch off drive-ready state.

In this way, standby state remains switched on, and a Check Control message is displayed.

The vehicle can roll.

The parking brake is engaged automatically after approx. 35 minutes.

If the system is not operational, you may not be able to change the selector lever position.

If necessary, release the transmission lock electronically.

Additional information:

Electronic unlocking of the transmission lock, refer to page [121](#).

Kickdown

Kickdown is used to achieve maximum driving performance.

Step on the accelerator pedal beyond the resistance point at the full throttle position.

Without shift paddles: LOW mode

Principle

LOW mode is recommended when the engine braking effect needs to be increased, for instance on steep downhill gradients.

General information

In LOW mode, the transmission continues shifting automatically, but generally in lower gears than in selector lever position D.

LOW mode can therefore also be used to accelerate faster.

Enabling LOW mode

To activate LOW mode, tap the selector lever from selector lever position D to D/L. The transmission's LOW mode is enabled.

Exiting LOW mode

To activate LOW mode, pull the selector lever to D/L.

D is shown on the Interaction Unit.

With shift paddles: S program

Principle

The shifting points and shifting times in the Sport program are designed for sportier handling. The transmission, for instance shifts up later and the shifting times are shorter.

Activating the Sport program

To activate the Sport program, tap the selector lever toward selector lever position D/S. The sport program of the transmission is activated.

Ending the Sport program

To stop the Sport program, tap the selector lever toward selector lever position D/S.

The engaged selector lever position is shown on the Interaction Unit.

Electronic unlocking of the transmission lock

General information

Unlock the transmission lock electronically, e.g., to maneuver the vehicle out of a hazardous area in the event of a malfunction.

Before unlocking the transmission lock, secure the vehicle against rolling away, for instance with a wheel chock.

Engaging selector lever position N

To engage selector lever position N, proceed as follows:

1. Quickly turn the Start/Stop switch three times without pressing the brake.
2. Depress the brake pedal.
3. Within 30 seconds, press the selector lever to position N until position N appears on the selector lever.
A Check Control message is displayed.
4. Maneuver the vehicle from the hazardous area and secure it against rolling away.

Shift paddles

Principle

The shift paddles on the steering wheel are used to change gears manually.

General information

Shifting

The vehicle only shifts at suitable RPM and road speeds.

Even in manual mode, the transmission shifts automatically in certain situations, e.g., when speed limits are reached.

Temporary manual mode

In selector lever position D, pulling a shift paddle switches into manual mode temporarily.

In manual mode, if the vehicle is driven with a restrained style for a certain period of time, does not accelerate, and is not shifted with the shift paddles, the transmission switches back to automatic mode.

It is possible to switch into automatic mode:

- Pull and hold the right shift paddle until D is shown on the Interaction Unit.
- In addition to the pulled right shift paddle, pull the left shift paddle.

Continuous manual mode

In Sport program S, pulling a shift paddle switches to manual mode M.

It is possible to switch into automatic mode:

- Pull and hold the right shift paddle until S is shown on the Interaction Unit.
- In addition to pulling the right shift paddle, tap the left shift paddle.
- Pull the selector lever to D/S.

When M2 is set manually while the vehicle is stationary, the transmission will no longer shift back to M1. This shift behavior is maintained until M1 is engaged manually or manual mode M is exited.

Shifting



- To upshift, pull the right shift paddle.
- To downshift, pull the left shift paddle.

The selected gear is shown briefly on the Interaction Unit, then the current gear is shown again.

Advanced mode

General information

Depending on vehicle equipment, the Steptronic transmission offers an advanced mode with adapted shift characteristics.

- Automatic downshift to lowest possible gear.

If the left shift paddle is pulled and held, the Steptronic transmission automatically shifts down to the lowest possible gear.

- Avoid automatic upshifting in manual mode.

In manual mode, the Steptronic transmission does not shift up automatically when speed limits are reached.

- There is no downshifting for kickdown.

Enabling advanced mode

Advanced mode activates in situations like the following:

- Transmission in manual mode.
- "SPORT PLUS": Settings under Drive in Go Kart Mode in MINI Modes.

Launch Control

Principle

Under dry ambient conditions, Launch Control ensures optimal acceleration on roads with good traction.

General information

Using Launch Control causes premature component wear since this function represents a very heavy load for the vehicle.

Do not turn the steering wheel when driving off with Launch Control.

Do not use Launch Control when breaking in the vehicle.

Additional information:

Break-in, refer to page [274](#).

Functional requirement

Launch Control can be used when the engine is at operating temperature. The engine is at operating temperature after an uninterrupted trip of at least 6 miles/10 km.

Driving off with Launch Control

To drive off with Launch Control, proceed as follows:

1. Switch on drive-ready state.
2. Activate Go Kart Mode.
3. Enable the driving dynamics setting: "SPORT PLUS".
4. With the left foot, press down forcefully on the brake.
5. Engage forward gear.
6. Press the accelerator pedal all the way down and hold.

Launch Control information is shown on the Interaction Unit.

7. The starting engine speed adjusts. Wait briefly until the engine speed is con-

stant. Keep the accelerator pedal in this position.

8. Release the brake within a few seconds of the Launch Control information illuminating.

The vehicle accelerates.

Upshifting is performed automatically.

Launch Control stays on as long as the Launch Control information is displayed and the accelerator pedal is not released.

Repeated use during a trip

After Launch Control has been used, the transmission must cool down for a short time before Launch Control can be used again. Launch Control adjusts to the surrounding conditions when used again.

After using Launch Control

To support driving stability, reactivate Dynamic Stability Control as soon as possible.

System limits

An experienced driver may be able to achieve better acceleration values in DSC OFF without Launch Control mode.

Sport Boost function

Principle

The SPORT BOOST function can be used for upcoming acceleration, for example.

This function is operated with the shift paddles on the steering wheel.

The system prepares the vehicle.

Overview



The shift paddles are located on the steering wheel.

Using the function

1. To activate the Sport Boost function, pull and hold the left shift paddle.
 - The function is active.
 - A countdown is shown on the Interaction Unit.
2. Before the countdown has finished, depress the accelerator pedal.
 - The vehicle accelerates.



BOOST is shown on the Interaction Unit.

The countdown can be restarted, for example if the function cannot be used immediately.

To restart the countdown, pull and hold the left shift paddle again until the countdown is reset.



Stopping the function

The function is automatically interrupted if the countdown has finished or if the function was used in the acceleration process.

Deactivating the function

Pull and hold the right shift paddle until the BOOST indicator disappears.

MINI Modes

Principle

MINI Modes are used to adjust vehicle handling and customize the overall experience in the interior.

The various modes are used to adapt the vehicle to the respective situation.

General information

Depending on the equipment, the following systems are affected, for instance:

- Drive system.
- Steering.
- Display on the Interaction Unit.
- Comfort functions in vehicle interior.
- MINI Sound.
- Lighting effects in vehicle interior.

Overview



The MINI Modes switch is located on the switch cluster and labeled EXPERIENCE.

Display

The selected mode is shown by specific colors and indicators on the Interaction Unit and Head-up display, depending on vehicle equipment.

MINI Modes in detail

General information

MINI Modes are used to adjust vehicle handling. They are also referred to as driving modes.

Various MINI Experience Modes can be used, depending on vehicle equipment.

Core Mode

Core Mode is a drive mode that provides for comfort-related settings.

Go Kart Mode

Go Kart Mode is a driving mode that provides increased vehicle agility.

Individual settings, e.g., for driving dynamics, chassis, and drive system, can be configured as needed.

"SPORT PLUS": Under Driving Dynamics, this setting deactivates Dynamic Stability Control, thus limiting driving stability.

Additional information:

- Dynamic Stability Control, refer to page [193](#).
- Setting for increased driving dynamics, refer to page [195](#).

Green Mode

Green Mode is a drive mode that provides consumption-optimized tuning and anti-

patory display. The interior lighting is also reduced here, for example.

MINI Experience Modes in detail

In addition to MINI Modes, there are also MINI Experience Modes. MINI Experience Modes are not used to adjust vehicle handling, but rather to customize the lighting effects in the interior, for example.

– Balance Mode

Balance Mode is a driving mode that ensures a pleasant ambiance and a relaxed drive.

– Personal Mode

Personal Mode is a mode that offers special customization options. A personalized background image, for example, can be chosen for the Interaction Unit.

– Timeless Mode

Timeless Mode is used when driving with the MINI retro design.

– Vivid Mode

Vivid Mode is a mode that ensures a vibrant audio experience and impressive ambient lighting effects in the vehicle interior.



Selecting a mode

To select the desired mode, proceed as follows:

1.  Press the MINI Modes button on the switch cluster.
2. Select the desired mode by pressing the switch again.

Configuring modes



Some modes can be configured individually. To configure the desired mode, proceed as follows:

1.  Press the MINI Modes button on the switch cluster.
2.  Tap the Settings icon on the Interaction Unit.
3. Select the desired settings.

Changing the start mode



Some modes can be set as the start mode. The set start mode activates when drive-ready state is turned on.

To configured the desired start mode, proceed as follows:

1.  Press the MINI Modes button on the switch cluster.
2.  Tap the Settings icon on the Interaction Unit.
3. Select the desired start mode.

Experience View

When a mode is activated, specific views are displayed on the Interaction Unit. These specific views can be unselected in the settings as follows:

1.  Press the MINI Modes button on the switch cluster.
2.  Tap the Settings icon on the Interaction Unit.
3. "Experience View"
4. Select the desired setting.



Parking brake

Principle

The parking brake is used to prevent the vehicle from rolling away when it is parked.

Safety information

Warning

An unsecured vehicle can begin to move and possibly roll away. There is a risk of accident, injury, or property damage. Before leaving the vehicle, secure the vehicle against rolling away.

In order to ensure that the vehicle is secured against rolling away, follow the following:

- Set the parking brake.
- On uphill grades or on downhill slopes, turn the front wheels in the direction of the curb.
- On uphill grades or on downhill slopes, also secure the vehicle, for instance with a wheel chock.

Warning

Unattended children or animals in the vehicle can cause the vehicle to move and endanger themselves and traffic, for example, due to the following actions:

- Establishing standby.
- Releasing the parking brake.
- Opening and closing the doors or windows.
- Engaging selector lever position N.
- Using vehicle equipment.

There is a risk of accident, injury, or property damage. Do not leave children or animals unattended in the vehicle. Take the vehicle key with you when exiting and lock the vehicle.

Overview

Button in the vehicle



-  The parking brake button is located on the switch cluster.

Setting the parking brake

With a stationary vehicle

-  To engage the parking brake, press the parking brake button on the switch cluster.

The LED in the button illuminates.

-  The indicator light on the Interaction Unit illuminates red.

The parking brake is engaged and transmission lock is engaged.

While driving

Using the parking brake while driving serves as emergency braking.

-  To brake the vehicle, press and hold the parking brake button on the

switch cluster. The vehicle brakes hard for as long as the button is pressed.



The indicator light on the Interaction Unit illuminates red, a signal sounds, and the brake lights illuminate.

A Check Control message is displayed.

The parking brake is engaged and the transmission lock is set when the vehicle is stationary.

Engaging the parking brake automatically

In some situations, the parking brake is engaged automatically, e.g., through Automatic Hold.

Additionally, the system can be set to automatically engaging the parking brake when the drive-ready state is turned off.

To do so, go through the menu as follows: Apps menu / "Vehicle" / "Driving settings" / "Drivetrain and chassis" / "Apply automatically".

In selector lever position N, the parking brake will not be engaged automatically.

Releasing the parking brake

Releasing the parking brake manually

Follow these steps to manually release the parking brake:

1. Switch on drive-ready state.

2.  On the switch cluster, press the parking brake button with the brake applied or selector lever position P engaged.

The LED and the indicator light go out.

The parking brake is released.

Releasing the parking brake automatically

The parking brake is released automatically when you drive off.

The LED and the indicator light go out.

Malfunction

If the parking brake fails or malfunctions, secure the vehicle so that it does not roll away before you exit.

A Check Control message appears on the Interaction Unit.

Secure the vehicle against rolling away, for instance with a wheel chock, after getting out of the vehicle.

After a power interruption

To reestablish parking brake operability after a power interruption, an initialization may be required.

1. Turn on standby state.

2.  Press the parking brake button.

3.  Press the parking brake button again after 2 seconds.

The Check Control messages for the parking brake go out.

Possible function-related noises are normal.



The red indicator light shows that the parking brake is ready again.



Automatic Hold

Principle

Automatic Hold assists the driver by automatically setting and releasing the brake such as when moving in stop-and-go traffic.

When a gear position is engaged, the vehicle is automatically held in place when it is stationary.

On uphill grades the system prevents the vehicle from rolling back when driving off.

General information

The parking brake is applied automatically by Automatic Hold under the following situations:

- Drive-ready state is switched off.
- The driver's door is open for more than one second and no pedal is pressed during this time.
- The moving vehicle is brought to a standstill using the parking brake.

In selector lever position N, Automatic Hold is temporarily deactivated.

There are two ways to activate and deactivate Automatic Hold:

- Via the Interaction Unit.
- Using the brake pedal.

Safety information

Warning

An unsecured vehicle can begin to move and possibly roll away. There is a risk of accident, injury, or property damage. Before leaving the vehicle, secure the vehicle against rolling away.

In order to ensure that the vehicle is secured against rolling away, follow the following:

- Set the parking brake.
- On uphill grades or on downhill slopes, turn the front wheels in the direction of the curb.
- On uphill grades or on downhill slopes, also secure the vehicle, for instance with a wheel chock.

Warning

Unattended children or animals in the vehicle can cause the vehicle to move and endanger themselves and traffic, for example, due to the following actions:

- Establishing standby.
- Releasing the parking brake.
- Opening and closing the doors or windows.
- Engaging selector lever position N.
- Using vehicle equipment.

There is a risk of accident, injury, or property damage. Do not leave children or animals unattended in the vehicle. Take the vehicle key with you when exiting and lock the vehicle.

Activating Automatic Hold via the menu

To activate Automatic Hold via the menu, proceed as follows:

1. Drive-ready state is on and the vehicle is stationary.
2. Go through the menu as follows: Apps menu / "Vehicle" / "Driving settings" / "Drivetrain and chassis".
3. Select "Automatic Hold".



When driving, the gray indicator light indicates that Automatic Hold is ready.



When stationary, the indicator light illuminates green to indicate that Automatic Hold is on.

Activating Automatic Hold using the brake pedal

To activate Automatic Hold using the brake pedal, the vehicle must be at a standstill. Proceed as follows to activate:

1. Switch on drive-ready state.
2. Depress the brake pedal until some resistance is perceptible. Then depress the brake pedal firmly.



As soon as Automatic Hold turns on, the indicator light illuminates green and a Check Control message appears.



When driving, the indicator light changes from green to gray to show that Automatic Hold is ready.

Automatic Hold holding the vehicle

Automatic Hold is activated and the driver's door is closed.



After stopping, the vehicle is automatically secured against rolling away as soon as the indicator light illuminates green.

Driving off

Press the accelerator pedal to drive off.

The brake is released automatically and the indicator light of the parking brake is no longer illuminated.

Automatic parking brake application

The parking brake is automatically set if drive-ready state is switched off while the

vehicle is being held by Automatic Hold or if the vehicle is exited.



The indicator light changes from green to red.

The parking brake is not set automatically if the drive-ready state was switched off while the vehicle was coasting. Automatic Hold is temporarily deactivated in this case.

Deactivating Automatic Hold via the menu

1. To activate/deactivate Automatic Hold, go through the menu as follows: Apps menu / "Vehicle" / "Driving settings" / "Drivetrain and chassis".
2. Select "Automatic Hold".

The indicator light goes out.

Automatic Hold is switched off.

If the vehicle is being held by Automatic Hold, also press on the brake pedal when switching off.

Deactivating Automatic Hold using the brake pedal

To deactivate Automatic Hold using the brake pedal, the vehicle must be at a standstill:

1. Depress the brake pedal until some resistance is perceptible.
2. Then depress the brake pedal firmly.

The indicator light goes out and a Check Control message appears.

Automatic Hold is deactivated.

Automatic Hold in the driver profile

The current status of Automatic Hold is saved to the driver profile currently being used. If the driver profile is changed, the saved settings are applied. If the driver pro-



file is changed while drive-ready state is on, Automatic Hold can only be activated.

Automatic Hold is only deactivated when drive-ready state is turned off.

Displays

Vehicle features and options

This chapter describes model-specific equipment, systems, and functions that are currently available, or may become available in the future, even if they are not present in the vehicle.

Additional information:

Vehicle equipment, refer to page 8.

Trip data

Principle

The trip data display provides various information about the trip, e.g., average consumption or trip distance.

The values can be displayed and reset depending on different intervals.

Viewing trip data

The Interaction Unit can be used to view the trip data. There are several ways to view trip data:





- Go through the menu as follows: Apps menu / "Vehicle" / "Trip data".
- Tap the range value on the Interaction Unit.
- On the Interaction Unit, tap the odometer reading in the speedometer.

Additional information:

Speedometer, refer to page 139.

Display

The following trip data is displayed:

- Configured interval for displaying trip data.
-  Average fuel consumption depending on the configured interval.
-  Travel time depending on the configured interval.
-  Distance traveled depending on the configured interval.
-  Distance traveled in Coasting mode.

Current consumption

The current fuel consumption display allows you to check the current fuel consumption, e.g., to drive economically and in an environmentally-friendly manner.

Average consumption

The average fuel consumption is displayed depending on how the interval for displaying trip data is configured.

Adjusting the display of the trip data

The intervals for displaying trip data can be configured.

1. To go to the Trip Data menu: Apps menu / "Vehicle" / "Trip data".
2. Tap the interval button.
3. Select the desired setting:
 - "for this trip": the values are automatically reset approx. four hours after the vehicle has come to a standstill.
 - "since last refuel": the values are automatically reset after refueling with a larger quantity of fuel.



- "since factory": the values since the time of the factory delivery are displayed.
- "since Individual": the values since the last manual reset are displayed. The values can be reset at any time.

Resetting average values manually

The average trip data values can be reset manually. The following interval is activated and the average values are reset: "since Individual".

Via the Interaction Unit:

1. Go through the menu as follows: Apps menu / "Vehicle" / "Trip data".
2.  Tap the button for resetting trip data.

MINI Head-up display

Principle

The Head-up display projects important information in the driver's field of view, for instance the speed. Information can be recorded without you having to look away from the road.

The Head-up display can be configured as necessary, e.g., adjust the brightness.

General information

Follow instructions for cleaning the Head-up display in the Vehicle Care chapter.

Additional information:

Caring for special components, refer to page 344.

Safety information

Warning

When extending and retracting the projection screen of the Head-up display, body parts can be jammed. There is a risk of injury. Make sure that the area of movement of the projection screen is clear when extending and retracting.

NOTICE

The Head-up display consists of sensitive components that can easily be scraped or damaged. There is a risk of damage to property. Do not place any objects on the Head-up display, attach to system components or plug into the system. Do not move the moving parts manually.

Overview



The Head-up display is switched on.

Displayable information

The following information is displayed on the Head-up display:

- Speed.
- Navigation instructions.
- Check Control messages.
- Shift lights.

- Depending on vehicle equipment: Sport Boost function.
- Lists and messages.
- The driver assistance systems.

Some of this information is only displayed briefly as needed.

Turning the Head-up display on/off

When switching on, the projection screen of the Head-up display is extended. When switching off, the projection screen of the Head-up display is retracted again.

To turn the Head-up display on/off, go through the menu as follows: Apps menu / "Vehicle" / "Displays" / "Head-up display" / "Head-up display".

Settings

Individual settings can be entered for the Head-up display such as for the height, brightness or illustration. You can also set up specific views on the Head-up display separately, e.g., for Driver Assistance information.

1. Go through the menu as follows: Apps menu / "Vehicle" / "Displays" / "Head-up display".
2. Select the desired setting.

Depending on vehicle equipment, the height of the Head-up display can be stored using the memory function.

Visibility of the display

The visibility of the displays in the Head-up display is influenced by the following factors:

- Seat position.
- Dust or dirt on the projection screen of the Head-up display.
- Sunglasses with certain polarization filters.

- Wet road.
- Unfavorable light conditions.

Check Control

Principle

The Check Control system monitors functions in the vehicle and notifies you of faults in the monitored systems.

A Check Control message, combining indicator lights or warning lights and text, appears on the Interaction Unit and Head-up display, where applicable. In addition, an acoustic signal may sound.

Some Check Control messages are hidden automatically after approx. 20 seconds, but they will be stored. Stored Check Control messages can be displayed on the Interaction Unit. Urgent Check Control messages are permanently displayed but may be hidden temporarily.

Hiding Check Control messages

Permanently displayed Check Control messages can be hidden temporarily. These messages are automatically displayed again after approx. 8 seconds.

✕ The close icon next to the Check Control message indicates whether the Check Control message can be hidden.

Displaying stored Check Control messages

Saved Check Control messages and additional information such as the cause of a fault or the required action can be called up via Check Control.

Depending on the Check Control message, further help can be selected.

1. Go through the menu as follows: Apps menu / "Vehicle" / "Vehicle status" / "Check Control".
2. Select the desired text message.

Display

A Check Control message, consisting of text and an icon, is displayed. Additional instructions can be viewed by tapping on the text.

If several faults occur at once, the messages are displayed consecutively.

Certain messages displayed while driving are displayed again after drive-ready state is switched off.



Icons next to the menu bar indicate whether a Check Control message is active or saved.



Indicator lights and warning lights

Principle

The indicator lights and warning lights show the status of some vehicle functions or indicate when there is a fault in monitored systems.

Indicator lights and warning lights can illuminate in a variety of combinations and colors.

Some indicator lights are checked for proper functioning and illuminate temporarily when drive-ready state is turned on.

Red lights

Seat belt reminder



The seat belt on the driver's seat is not engaged.

Additional information:

Seat belt reminder, refer to page [100](#).

Airbag system



Warning light illuminates briefly: Indicates that the entire airbag system and seat belt tensioners are operational when drive-ready state is switched on.

Warning light does not illuminate or illuminates continuously: The airbag system or seat belt tensioners may not be operational. Have the vehicle checked immediately by an authorized service center or another qualified service center or repair shop.

Additional information:

Airbags, refer to page [161](#).

Parking brake



The parking brake is set.

Additional information:

Parking brake, refer to page [126](#).

Brake system



The brake pads are worn or there is another issue with the brake system.



The braking assistance may not be operational. A higher pedal force may be required for the braking process.

Have the vehicle checked immediately by an authorized service center or another qualified service center or repair shop.

Risk of collision



The warning light illuminates or flashes in conjunction with an acoustic signal if there is a risk of imminent collision.

Additional information:

Forward Collision Mitigation, refer to page [167](#).

Pedestrian Warning



The warning light illuminates: risk of collision with a person, e.g., a pedestrian or a cyclist detected. Increased awareness is required.

The warning light flashes and a signal sounds: risk of imminent collision with a person, e.g., a pedestrian or a cyclist detected. Immediately initiate braking or an evasive maneuver.

Additional information:

Warning function for pedestrians, refer to page [173](#).

Forward Collision Warning



The warning light illuminates: risk of collision, e.g., with a vehicle detected. Increased awareness is required.

The warning light flashes and a signal sounds: risk of imminent collision with a vehicle detected. Immediately initiate braking or an evasive maneuver.

Additional information:

Warning function in rear-end collision situations, refer to page [170](#).

Intersection Collision Warning: vehicle detected from the right



The warning light illuminates: risk of collision with a vehicle crossing

from the right detected. Increased awareness is required.

The warning light flashes and a signal sounds: risk of imminent collision with a crossing vehicle detected. Immediately initiate braking or an evasive maneuver.

Additional information:

Warning function at intersections, refer to page [174](#).

Intersection Collision Warning: vehicle detected from the left



The warning light illuminates: risk of collision with a vehicle crossing from the left detected. Increased awareness is required.

The warning light flashes and a signal sounds: risk of imminent collision with a crossing vehicle detected. Immediately initiate braking or an evasive maneuver.

Additional information:

Warning function at intersections, refer to page [174](#).

Distance control



Warning light flashes and acoustic signal sounds: Brake and evade as necessary.

Additional information:

Distance Control, refer to page [204](#).

Assisted Driving Mode



Warning light flashes and signal sounds: The system is switched off or will be interrupted very soon.

Additional information:

Assisted Driving Mode, refer to page [210](#).

Assisted Driving Mode: Hands are not on steering wheel



Warning light illuminates and acoustic signal sounds:

Hands are not grasping the steering wheel. System interruption is imminent.

The system reduces the speed to a standstill if applicable.

It is possible that the system will not execute any supporting steering movements.

Grab the steering wheel immediately with your hands.

Additional information:

Assisted Driving Mode, refer to page 210.

Yellow lights

Antilock Braking System



The system may not be operational. The Antilock Braking System is not available.



The ability to steer may be restricted during full braking.

Have the vehicle checked immediately by an authorized service center or another qualified service center or repair shop.

Additional information:

Antilock Braking System, refer to page 193.

Assisted Driving Mode



Warning light illuminates and acoustic signal sounds: A system interruption is imminent.

Warning light flashes: A lane boundary has been crossed.

Additional information:

Assisted Driving Mode, refer to page 210.

Assisted Driving Mode: Hands are not on steering wheel



Steering wheel icon illuminates yellow: Do not grip the steering wheel with your hands. The system is still active.

Grab the steering wheel with your hands.

Additional information:

Assisted Driving Mode, refer to page 210.

Dynamic Stability Control



Warning light flashes: Dynamic Stability Control is regulating the driving and brake power. The vehicle is stabilized. Reduce the vehicle speed and adjust your driving style to the road conditions.

Warning light illuminates: Dynamic Stability Control has malfunctioned or is initializing. Driving stabilization is restricted or has failed.

If the warning light illuminates continuously, have the vehicle checked immediately by an authorized service center or another qualified service center or repair shop.

Additional information:

Dynamic Stability Control, refer to page 193.

Dynamic Stability Control deactivated, or increased driving dynamics activated



Dynamic Stability Control is deactivated or enhanced driving dynamics is activated.

Additional information:

- Dynamic Stability Control, refer to page 193.
- Setting for increased driving dynamics, refer to page 195.

Drive-off support



Drive-off support is activated.

Additional information:

Drive-off support, refer to page 196.

Flat tire monitor



Warning light illuminates: Flat Tire Monitor is indicating a flat tire or tire pressure loss.

Reduce your speed and stop cautiously. Avoid sudden braking and steering maneuvers.

Additional information:

Flat tire monitor, refer to page 307.

Tire pressure monitor



Warning light illuminates: Tire Pressure Monitor is indicating a flat tire or tire pressure loss. Follow the information in the Check Control message.

Warning light flashes then illuminates continuously: Flat tires or tire pressure losses cannot be detected.

- Fault caused by systems or devices with the same radio frequency: after leaving the area of the interference, the system automatically becomes active again.
- In the case of tires with special approval: the tire pressure monitor was unable to complete the reset. Reset the system again.
- Wheel without wheel electronics installed: Have it checked by an authorized service center or another qualified service center or repair shop as needed.
- Malfunction: have the vehicle checked by an authorized service center or another qualified service center or repair shop.

Additional information:

Tire pressure monitor, refer to page 300.

Steering system



The steering system may not be operational.

Have the vehicle checked by an authorized service center or another qualified service center or repair shop.

Exhaust emissions



- The warning light illuminates: The exhaust gas quality is declining, e.g., because the fuel filler cap is fitted incorrectly. Have the vehicle checked as soon as possible.

- The warning light flashes under certain circumstances: This indicates that there is excessive misfiring in the engine. Reduce the vehicle speed and have the vehicle checked immediately; otherwise, serious engine misfiring within a brief period can seriously damage emission control components, in particular the catalytic converter.

Additional information:

Socket for OBD on-board diagnostics, refer to page 326.

Green lights

Turn signal



The turn signal is turned on.

If the indicator light is flashing unusually fast, this indicates that a turn signal bulb has failed.

Additional information:

Turn signal, refer to page 147.



Parking lights



The parking lights are turned on.

Additional information:

Parking lights, low-beam headlights, refer to page [151](#).

Low-beam headlights



The low-beam headlights are turned on.

Additional information:

Parking lights, low-beam headlights, refer to page [151](#).

Automatic High Beam Assistant



Low-beam headlights are on and Automatic High Beam Assistant is enabled.

The high-beam headlights are turned on and off automatically depending on the traffic.

Additional information:

Automatic High Beam Assistant, refer to page [148](#).

Lane departure warning



Depending on vehicle equipment and national-market version:

Indicator light flashes: System is performing a steering intervention.

Additional information:

Lane departure warning, refer to page [178](#).

Automatic Hold holding the vehicle



After stopping, the vehicle is automatically secured against rolling away as soon as the indicator light illuminates green.

Additional information:

Automatic Hold, refer to page [128](#).

Cruise Control



The system is active.

Additional information:

Cruise control, refer to page [201](#).

Distance control



Indicator light illuminates: Vehicle has been detected ahead of you. The vehicle icon goes out if no vehicle has been detected ahead of you.

Indicator light flashes: Preceding vehicle has driven off.

Additional information:

Distance Control, refer to page [204](#).

Speed Limit Assistant



The detected speed limit can be applied with the SET button. As soon as the speed limit has been applied, a green checkmark is displayed.

Additional information:

Speed Limit Assistant, refer to page [214](#).

Assisted Driving Mode



The system supports the driver in keeping the vehicle within the lane.

Additional information:

Assisted Driving Mode, refer to page [210](#).

Blue lights



High-beam headlights have been turned on.

Additional information:

High-beam headlights, refer to page [147](#).

Automatic High Beam Assistant



High-beam headlights have been turned on by the Automatic High Beam Assistant.

Additional information:

Automatic High Beam Assistant, refer to page [148](#).

Gray lights

Seat belt reminder



Seat belt on the passenger seat or another seat in the vehicle is not buckled.

Additional information:

Seat belts, refer to page [99](#).

Distance control



Indicator light flashes: The requirements to operate the system have not been met. The system was deactivated but applies the brakes until you actively resume control by pressing on the brake pedal or accelerator pedal.

Additional information:

Distance Control, refer to page [204](#).

Automatic Hold on standby



When driving, the indicator light shows that Automatic Hold is ready.

Additional information:

Automatic Hold, refer to page [128](#).

Assisted Driving Mode



The system is on standby and does not manipulate steering movements.

System activates automatically as soon as all function conditions are fulfilled.

Additional information:

Assisted Driving Mode, refer to page [210](#).

White lights

Cruise Control with Distance Control



No Distance Control because accelerator pedal is being pressed.

Additional information:

Distance Control, refer to page [204](#).

Speedometer

Principle

The speedometer provides detailed driving information next to the speed, e.g., mileage.

Overview



- 1 Tachometer [140](#)
- Power gauge [140](#)
- 2 Vehicle speed
- 3 Odometer reading [131](#)
- 4 Engine temperature [141](#)
- 5 Fuel gauge [144](#)

Displaying the speedometer

To display the speedometer, tap the speed value at the top of the Interaction Unit.

Power gauge

Principle

The power gauge indicates the currently drawn drive power as a percentage.

Enabling/disabling the power gauge

The power gauge or tachometer is displayed, depending on the drive mode selected.

Display



Needle near arrow 1: indicator for energy recovery, e.g., while decelerating.

Needle near arrow 2: Drive power in percent.

Reduced drive power

The available drive power may be reduced due to certain factors. The power gauge is automatically adjusted accordingly.

In addition, the icons on the power gauge and tachometer indicate reduced drive power.

Icon	Description
	Blue icon: cold drivetrain. White icon: increased drive system temperature, for instance due to sustained or high power demand when driving on mountain roads.
	Depending on vehicle equipment and national-market version: Drive power restriction determined by MINI Digital Key.
	System-related functional limitation. A Check Control message is displayed in addition where applicable.

Tachometer

General information

Always avoid RPM in the red warning field. In this range, the fuel supply is reduced to protect the engine.

Activating/deactivating the tachometer

The tachometer or power gauge is displayed depending on the drive mode selected.

Reduced rotational speed range

The available rotational speed range may be reduced due certain factors such as a cold drive system. The tachometer display is automatically adjusted depending on the available rotational speed range.



Standby state and drive-ready state

OFF

If OFF appears on the Interaction Unit, drive-ready state is turned off and standby state is turned on.

READY

If READY appears on the Interaction Unit, the Auto Start/Stop function is ready to start the engine automatically.

Additional information:

- Operating state of the vehicle, refer to page 39.
- Auto Start/Stop function, refer to page 115.

Engine temperature

Principle

The engine temperature is displayed on the speedometer.

Additional information:

Speedometer, refer to page 139.

Coolant, refer to page 322.

Display



- If the engine is cold, the needle is in the blue temperature range, close to

the limit position of the temperature display.

Drive at moderate RPM and vehicle speeds.

- At normal operating temperature, the needle is in the middle or in the left half of the temperature display.
- If the engine is hot, the needle is in the red temperature range. In addition, a Check Control message is displayed.

Indicator light



A red indicator light is displayed.

Selection lists

Principle





The Interaction Unit or Head-up display provide lists of certain functions, which can be operated as necessary:

- Entertainment source.
- Current audio source.
- List of recent calls.
- Shortcuts list.

If necessary, the corresponding menu will open.

Displaying and using the list

The selection lists can be displayed and operated using the operating elements on the steering wheel.

Operating elements	Function
	Change the entertainment source. Pressing the button again will close the currently displayed list.
	Show list of most recent telephone calls.
	Displaying the list of shortcuts.
	Turn the knurled wheel: display the list for currently selected entertainment source or scroll up or down in the list. Tilt knurled wheel in corresponding direction: Move selection to left or right. Press knurled wheel: confirm selection.

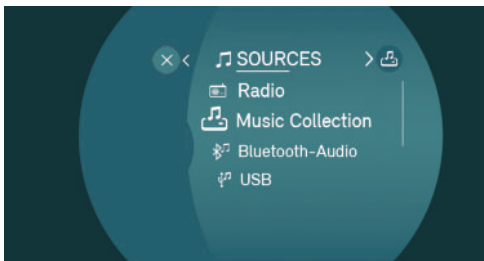

Additional information:
Shortcuts, refer to page 46.

Display





Selection lists, e.g., entertainment sources, are shown on the Head-up display and Interaction Unit.

Example: changing the entertainment source

-  To select an entertainment source, press the entertainment source button on the right of the steering wheel.
-  To select an entertainment source, turn the knurled wheel.
- Press the knurled wheel to confirm the selected entertainment source.

Example: selecting a radio station

-  To select a radio station, press the entertainment source button on the right of the steering wheel.
-  To switch to the radio stations list, tilt the knurled wheel to the right.
- Turn the knurled wheel to select a radio station.
- Press the knurled wheel to confirm the selected radio station.

Gear shift indicator

Principle

The shift point indicator recommends the gear that best suits the current driving situation. Using the optimal gear supports an efficient driving style.

General information

The gear shift indicator is active in manual mode M depending on vehicle equipment and national-market version.

Displays

Information on upshifting/downshifting or the engaged gear is displayed on the Interaction Unit.

On vehicles without a gear shift indicator, the engaged gear is displayed.

Example	Description
M3	In continuous manual mode M: Optimal gear is engaged.
D3	With shift paddles: temporary manual mode.
S3	With shift paddles: Sport program.
2•3	Shift information.

Additional information:

Shift paddles, refer to page [121](#).

Shift lights

Principle

Shift lights are temporarily displayed on the Head-up display and indicate the correct time to upshift in order to achieve rapid acceleration.

Functional requirement

Manual mode M must be activated for the shift lights to appear.

Display

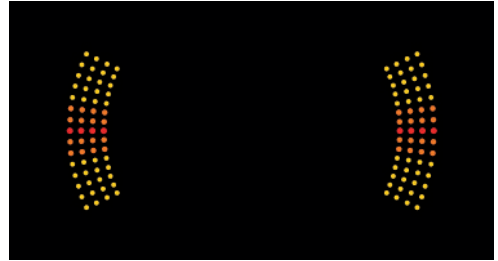

Successive fields illuminating yellow indicate an upcoming shift point.

- Shift before the red lights illuminate.
- When the maximum rotational speed is reached, the entire display flashes red and the fuel supply is interrupted in order to protect the engine.

Range

Principle

The range indicates the distance that can still be covered with the current tank of fuel.

General information

The estimated range with remaining fuel is displayed on the Interaction Unit.

With a low remaining range, a Check Control message is briefly displayed. A low remaining range means that engine functions cannot always be ensured for sporty driving, e.g., when cornering at speed.

The Check Control message appears continuously below a range of approx. 30 miles/50 km.

Safety information

NOTICE

With a range below 30 miles/50 km, the engine may no longer have sufficient fuel. Engine functions are not ensured anymore. There is a risk of damage to property. Refuel promptly.

Display

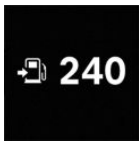

The current range is displayed as a numerical value next to the fuel gauge.

Fuel gauge

Principle

The current fill level of the fuel tank is displayed.

General information

Vehicle inclination may cause the display to vary.

Additional information:

Refueling, refer to page [284](#).

Display

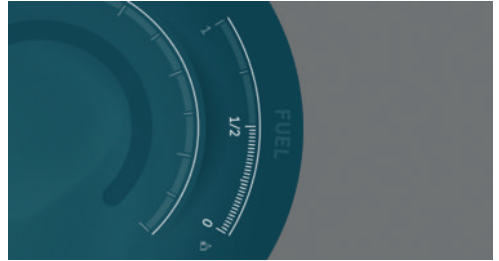

Under the fuel gauge, an arrow next to the fuel pump symbol indicates which side of the vehicle the fuel filler flap is on.

The current range is displayed as numerical value.

Indicator light



The yellow indicator light illuminates, once the fuel reserve is reached.

Vehicle status





General information

The status can be displayed and actions performed for several systems such as for Check Control.

Displaying vehicle status

To display the vehicle status, go through the menu as follows: Apps menu / "Vehicle" / "Vehicle status".

Overview

Icon	Description
	"Flat Tire Monitor": Status of the flat tire monitor, refer to page 307.
	"Tire Pressure Monitor": status of the Tire Pressure Monitor, refer to page 300.
	"Engine oil level": electronic oil measurement, refer to page 320.
	"Check Control": displaying stored Check Control messages, refer to page 133.
	"Service": display of the service notifications, refer to page 146.

ing and braking at any time, and actively intervene where appropriate.

Display



An example of active Driver Assistance: Indicator lights and warning lights for Distance Control and Assisted Driving Mode are displayed. At the same time, the Distance Control is animated in Assisted View.



Assisted View can also be activated for the Head-up display via Settings.

Assisted View

Principle

With Assisted View, information on driver assistance systems can be shown with the help of a vehicle animation.

Safety information

Warning

The system cannot serve as a substitute for the driver's personal judgment in assessing the traffic situation. Based on the limits of the system, it cannot independently react to all traffic situations. There is a risk of accident, injury, or property damage. Adjust driving style to traffic conditions. Watch the surrounding traffic situation closely, be ready to take over steer-

System limits

The system's detection capability is limited. Only objects that are detected by the system are taken into account.

Additional information:

- Cameras, refer to page 34.
- Radar sensors, refer to page 35.

Outside temperature

General information

If the indicator drops to +37°F/+3°C or lower, a signal sounds.

A Check Control message is displayed.

There is an increased risk of ice on roads.



Safety information

Warning

Even at temperatures above +37 °F/+3 °C there is a risk of icy roads, for instance on bridges or shady sections of the road. There is a risk of accident, injury, or property damage. Modify your driving style to the weather conditions at low temperatures.

Date and time

Various settings can be configured for displaying the date and time.

Depending on vehicle equipment and national-market version, the time zone can be set manually or automatically. Automatic time zone adjustment automatically updates the time, date, and time zone as necessary.

The date is set automatically based on the time zone.

1. Go through the menu as follows: Apps menu / "Vehicle" / "System settings" / "Time".
2. Select the desired settings.

Setting the units of measurement

Depending on the national-market version, you can set the units of measurement for some values, for instance consumption, distances, and temperature.

1. Go through the menu as follows: Apps menu / "Vehicle" / "System settings" / "Units".
2. Select the desired setting.

Service

Principle

The service notifications indicate recommended maintenance work.

General information

After switching on the vehicle, the Interaction Unit briefly shows the next service appointment or the distance remaining until the next required maintenance.

A service advisor can read out the maintenance work from the vehicle key.

Display

More detailed information can be displayed.

1. Go through the menu as follows: Apps menu / "Vehicle" / "Vehicle status" / "Service".
Maintenance measures as well as legally mandated inspections are displayed.
2. Select the desired entry to bring up more information.

Entering appointment dates

The dates for mandatory vehicle inspections can be entered.

Make sure that the vehicle's date and time are set correctly.

1. Go through the menu as follows: Apps menu / "Vehicle" / "Vehicle status" / "Service" / "Vehicle inspection".
2. Select the desired setting.

Light and view

Vehicle features and options

This chapter describes model-specific equipment, systems, and functions that are currently available, or may become available in the future, even if they are not present in the vehicle.

Additional information:

Vehicle equipment, refer to page 8.

Turn signal

Principle

The turn signal indicates the change in your direction of travel. To indicate a turn, the following functions can be used:

- Flashing.
- One-touch signaling.
- Brief flashing.

Turn signal in exterior mirror

To ensure that the turn signal lamps on the exterior mirror are clearly visible, do not fold in the exterior mirrors while driving and while using the turn signals or hazard warning system.

Flashing

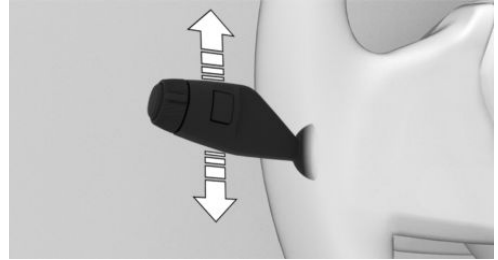

To flash the turn signal, push the turn signal lever up or down past the resistance point.

One-touch signaling

For one-touch signaling: Lightly tap the turn signal lever up or down.

The one-touch signaling duration can be adjusted.

1. Go through the menu as follows: Apps menu / "Vehicle" / "Exterior lighting" / or "Settings" / "One-touch turn signal".
2. Select the desired setting.

Brief flashing

To flash the turn signal briefly: Push the turn signal lever to the resistance point and hold it there for as long as you wish to indicate a turn.

High-beam headlights, headlight flasher

Principle

The high-beam headlights illuminate the road, also at great distances. The headlight flasher is used to emit a brief light signal



by actuating the high-beam headlights. The high-beam headlights can be switched on and off manually at any time.

High-beam headlights, turning headlight flasher on/off

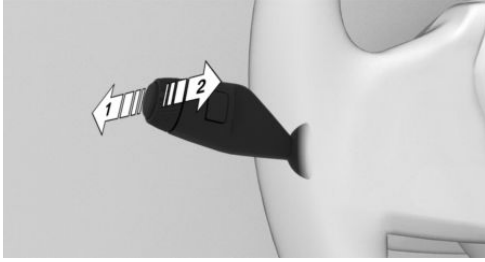

To turn on the high-beam headlights, push the turn signal lever forward, arrow 1. The high-beam headlights illuminate when the low-beam headlights are switched on.

To turn off the high-beam headlights or operate the headlight flasher, pull the turn signal lever backward, arrow 2.



The blue indicator light on the Interaction Unit illuminates when the high-beam headlights or headlight flasher are turned on.

Automatic High Beam Assistant

Principle

The Automatic High Beam Assistant promptly detects other road users as well as the ambient lighting, e.g., in towns, and automatically switches the high-beam headlights on or off depending on the traffic situation.

It may be necessary to activate the Automatic High Beam Assistant via the Interaction Unit before it can be used. You can use the turn signal lever to temporarily deacti-

vate or activate the Automatic High Beam Assistant, e.g., after turning your high-beam headlights on/off manually.

General information

In the low speed range, the high-beam headlights are not switched on by the Automatic High Beam Assistant.

Functional requirements

The following functional requirements apply to the Automatic High Beam Assistant:

- The automatic lights function is activated.
- The low-beam headlights are turned on.

Activating Automatic High Beam Assistant

The Automatic High Beam Assistant can be activated using the Interaction Unit.

1. Go through the menu as follows: Apps menu / "Vehicle" / "Exterior lighting" / "Headlights".
2. Tap the Automatic High Beam Assistant button.

The headlights are automatically changed between low-beam headlights and high-beam headlights.



The green indicator light on the Interaction Unit illuminates when the low-beam headlights are turned on.



The blue indicator light on the Interaction Unit illuminates when the system turns on the high-beam headlights.

If the Automatic High Beam Assistant is on and you continue driving after an interruption, the Automatic High Beam Assistant will remain on.

The Automatic High Beam Assistant is deactivated when manually switching the high-beam headlights on and off.

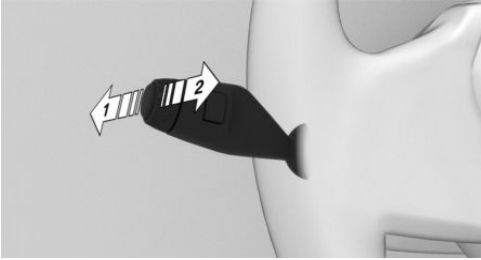

To reactivate the Automatic High Beam Assistant, press the turn signal lever up, arrow 1.

Deactivating Automatic High Beam Assistant

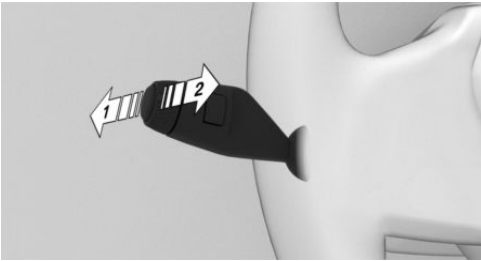

Press the turn signal lever forward, arrow 1, or pull the turn signal lever backward when the high-beam headlights are on, arrow 2.

When the Automatic High Beam Assistant is deactivated via the Interaction Unit, the high-beam headlights cannot be operated using the turn signal lever.

Sensitivity of the Automatic High Beam Assistant

General information

The sensitivity of the Automatic High Beam Assistant can be adjusted.

Safety information

Warning

If adjustments have been made or the sensitivity has been modified, oncoming traffic may be momentarily blinded. There is a risk of accident, injury, or property damage. If adjustments have been made and the sensitivity has been modified, make sure that oncoming traffic is not momentarily blinded. Switch off the high-beam headlights manually if required.

Functional requirements

The following functional requirements apply when adjusting the sensitivity of the Automatic High Beam Assistant:

- Adjustment is possible only while your vehicle is stationary.
- Drive-ready state is switched on.
- The light is switched off.

Increasing sensitivity

To increase the sensitivity of the Automatic High Beam Assistant, push the turn signal lever forward for approx. 10 seconds.

A Check Control message is displayed. The system responds more sensitively.

Resetting the sensitivity

To reset the sensitivity of the Automatic High Beam Assistant, push the turn signal lever forward again for approx. 10 seconds or switch off drive-ready state.

The sensitivity of the Automatic High Beam Assistant is reset to the factory settings.

System limits

The Automatic High Beam Assistant cannot replace the driver's personal judgment of when to use the high-beam headlights.

Therefore, when appropriate, turn off the high-beam headlights manually.

The system may not be fully operational in the following situations, and driver intervention may be necessary:

- In very unfavorable weather conditions such as fog or heavy precipitation.
- When detecting poorly-lit road users such as pedestrians, cyclists, horseback riders and wagons; when driving close to train or ship traffic; or at animal crossings.
- In tight curves, on hilltops or in depressions, in crossing traffic or half-obscured oncoming traffic on highways.
- In poorly-lit towns and cities or in the presence of highly reflective signs.
- When the windshield in the area in front of the interior mirror is fogged up, dirty or covered with stickers, etc.

Exterior lighting

Principle

The exterior lighting comprises all lighting elements on the outside of the vehicle. The exterior lighting, or individual functions of it, can be operated using the buttons in the vehicle or on the vehicle key, or via the Interactive Unit.

If the driver's door is opened when the drive-ready state is switched off, the exterior lighting is automatically switched off after a period of time.

Overview

Buttons in the vehicle

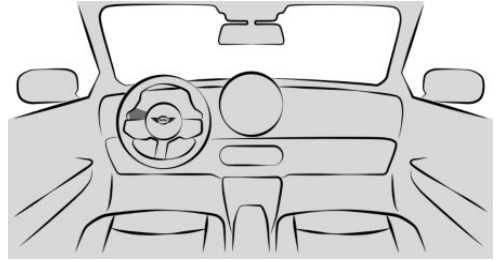





The exterior lighting switch and buttons are located on the turn signal lever, to the left of the steering wheel.



Icon	Function
	Exterior lighting menu.
	Low-beam headlights.
AUTO	Automatic headlight control.
OFF	Exterior lighting off.

Functions via the Interaction Unit

Icon	Function
AUTO	Automatic headlight control.
	Low-beam headlights.
OFF	Exterior lighting off.

Icon	Function
	Automatic High Beam Assistant.
	Parking lights.
	Left roadside parking light.
	Right roadside parking light.

Buttons on the vehicle key

Icon	Function
	Interior lighting. Parts of the exterior lighting.
	Pathway lighting.

Driving lights automatic

Principle

The automatic lights function switches the low-beam headlights on or off automatically depending on the ambient brightness, e.g., in tunnels, at dusk, or with precipitation.

General information

A blue sky with the sun low on the horizon can cause the lights to be turned on.

The automatic lights function is deactivated if you turn on the low-beam headlights manually.

Activate automatic headlight control

 To activate the automatic lights, turn the outer switch on the turn signal lever downward.

The LED under the automatic lights icon illuminates.

 The green indicator light on the Interaction Unit illuminates when the low-beam headlights are turned on.

System limits

The automatic headlight control cannot replace your personal judgment of lighting conditions.

For example, the sensors are unable to detect fog or hazy weather. In these situations, turn the lights on manually.

Low-beam headlights, parking light, and roadside parking light

Principle

The low-beam headlights are used to illuminate the road without dazzling oncoming traffic. The parking lights and roadside parking lights are used to illuminate the vehicle when stationary. These functions can be operated using the buttons in the vehicle or via the Interaction Unit.

Low-beam headlights

Turning on low-beam headlights

 To turn on the low-beam headlights, turn the outer switch on the turn signal lever upward.



The low-beam headlights illuminate when drive-ready state is switched on.



The green indicator light on the Interaction Unit illuminates when the low-beam headlights are turned on.

To turn on the low-beam headlights even when standby state is switched on, turn the outer switch on the turn signal lever upward again.

Turning off low-beam headlights

Depending on the national-market version, the low-beam headlights can be turned off in the low speed range:

-  Press the OFF button on the turn signal lever.
- Turn off the light via the Interaction Unit.

Parking lights

General information

The parking lights can only be turned on at low speeds.

Turning on parking lights

1. Go through the menu as follows: Apps menu / "Vehicle" / "Exterior lighting" / "Parking lights".
2. Tap the parking light button.



The green indicator light on the Interaction Unit illuminates when the parking light is turned on.

The vehicle is illuminated on all sides.

Do not use the parking lights for extended periods; otherwise, they might drain the vehicle battery and it would then be impossible to switch on drive-ready state.

Turning off parking lights

The following options are available to turn off the parking lights:

-  Press the OFF button on the turn signal lever.
- Turn off the light via the Interaction Unit.
- Switch on drive-ready state.

When drive-ready state is turned on, the automatic driving lights activate.

Roadside parking lights

When the vehicle is parked, a one-sided roadside parking light can be switched on.

1. Go through the menu as follows: Apps menu / "Vehicle" / "Exterior lighting" / "Parking lights".
2. Tap the roadside parking light button for the desired side of the vehicle.

Welcome lights

Principle

The welcome light turns on automatically for a limited period of time when approaching or unlocking the vehicle.

Depending on the equipment, the exterior lighting of the vehicle can be set individually.

Activating/deactivating welcome light

The welcome light can be activated or deactivated.

1. Go through the menu as follows: Apps menu / "Vehicle" / "Exterior lighting" / "Settings".
2. Select the desired setting, depending on vehicle equipment:
 - "Welcome and goodbye"

When unlocking the vehicle, individual lighting functions are turned on.

Turning on the welcome light

You can turn on the welcome light as follows:

- Automatic activation when approaching.
- Activation when unlocking vehicle.

-  With the vehicle locked, press the lock button on the vehicle key.

Depending on the settings, the interior lighting and parts of the exterior lighting will be turned on.

The function is not available for the first 10 seconds after locking.

Pathway lighting

Principle

For the pathway lighting, the exterior lighting that illuminates the vehicle's surroundings turns on for a certain period of time after leaving the vehicle.

Switching pathway lighting on

You can turn on the pathway lighting as follows:

- After switching off the drive-ready state, briefly push the turn signal lever forward.



- On the vehicle key, press and hold the panic alarm button for approx. 1 second.

Setting the duration

You can configure the duration of pathway lighting.

1. Go through the menu as follows: Apps menu / "Vehicle" / "Exterior lighting" / "Settings" / "Pathway lighting".
2. Select the desired setting.

Daytime driving lights

Principle

The daytime driving lights are used to ensure that the vehicle is more visible, e.g., in areas with sharply changing light conditions.

The daytime driving lights illuminate when drive-ready state is switched on.

Activating/deactivating daytime driving lights

In some countries, daytime driving lights are mandatory, so it may not be possible to deactivate the daytime driving lights in front.

1. Go through the menu as follows: Apps menu / "Vehicle" / "Exterior lighting" / "Settings".
2. Depending on vehicle equipment or national-market version, select the desired setting:
 - "Daytime driving lights"
 - "Rear daytime driving lights"



Adaptive lighting functions

Principle

The adaptive lighting functions provide dynamic illumination of the road.

The adaptive lighting functions may consist of one system or multiple systems, depending on the equipment version:

- Cornering light.

Activating the adaptive lighting functions

AUTO

To activate the adaptive lighting functions, turn the outer switch on the turn signal lever downward.

The LED on the turn signal lever illuminates.

The adaptive lighting functions are active when the drive-ready state is switched on.

Cornering light

In tight curves, for instance on mountainous roads or when turning, an additional cornering light is switched on that illuminates the inside of the curve when the vehicle is moving below a certain speed.

The cornering light is automatically switched on depending on the steering-wheel angle or, where applicable, the use of turn signals. When driving in reverse, the cornering lights may be automatically switched on regardless of the steering-wheel angle.

Adaptive headlight range control

The Adaptive Headlight Range Control compensates for vehicle acceleration, braking, and load conditions to prevent your headlights from dazzling oncoming traffic.

Automatic lights mode

Principle

With automatic lights mode, the appearance of the front and rear lights can be customized via the Interaction Unit.

Selecting automatic lights mode

1. To select automatic lights mode, go through the menu as follows: Apps menu / "Vehicle" / "Exterior lighting" / "Settings" / "Driving light mode".
2. Select the desired mode.

Instrument lighting

Principle

The instrument lighting illuminates switches and buttons with the individually set brightness.

The brightness of the instrument lighting can only be adjusted in darkness and when the parking lights or low-beam headlights are turned on.

Setting the brightness

The brightness of the instrument lighting can be adjusted.

1. Go through the menu as follows: Apps menu / "Vehicle" / "Interior lighting" / "Cockpit brightness".
2. Select the desired setting.

Interior lighting

Principle

The interior lighting comprises all lighting elements inside the vehicle. Depending on vehicle equipment, the interior lights, foot-well lights, entry lights, and ambient lights are controlled automatically.

Overview



The interior lighting menu button is located in the headliner.



The buttons for reading lights are located in the headliner.



The interior light button is located in the headliner.

Turning interior lights on/off

The interior lights can be turned on/off using the button in the headliner.



Press the interior light button in the headliner.

To turn off the interior light permanently, press and hold the button for approx. 3 seconds.

The interior lights in the rear of the vehicle can be switched on and off independently. The button is located in the rear headliner.

The interior lights can be turned on/off using the Interaction Unit.

1. Go through the menu as follows: Apps menu / "Vehicle" / "Interior lighting" / "Reading light".
2.  Select the interior lights icon.

Turning reading lights on/off

The reading lights can be turned on/off using the button in the headliner.



In the headliner, press the desired reading light button.

Depending on the vehicle equipment, the reading lights are located next to the interior lights in the front and rear.

The reading lights can also be turned on/off using the Interaction Unit.

1. Go through the menu as follows: Apps menu / "Vehicle" / "Interior lighting" / "Reading light".
2.  Select the icon for the desired seat reading light.

The brightness of the reading lights can be adjusted when they are turned on.



Changing settings

Depending on vehicle equipment, the brightness can be individually adjusted for specific seats.

1. Go through the menu as follows: Apps menu / "Vehicle" / "Interior lighting" / "Reading light".
2. Tap the desired seat.
3. Select the desired settings.

Ambient light

Principle

The ambient light comprises several light elements that provide diffuse light in the vehicle interior. Depending on the vehicle equipment, the Interaction Unit can be used to adjust the lighting level for some lights.

Activating/deactivating ambient light

To activate/deactivate the ambient light, go through the menu as follows: Apps menu / "Vehicle" / "Interior lighting" / "Ambient lighting" / "Ambient lighting".



Turning ambient light on/off

The ambient light is switched on when the vehicle is unlocked, and switched off when the vehicle is locked.

If the ambient light was disabled using the Interaction Unit, it will not turn on when the vehicle is unlocked.

Selecting the color

You can choose the color of the ambient light in Personal Mode.

1.  On the switch cluster, select Personal Mode using the MINI Modes switch.
2.  Tap the Settings icon on the Interaction Unit.
3. Select the desired setting.

Setting the brightness

The brightness of the ambient light can be adjusted.

1. Go through the menu as follows: Apps menu / "Vehicle" / "Interior lighting" / "Ambient lighting".
2. "Background light" or "Light projection"
3. Select the desired setting.

The light graphic is turned off in Green Mode.

Dynamic light

With Dynamic Light, certain things, e.g., obstacles detected when opening doors, are indicated by light effects. If the ambient light is disabled, the light effects are still displayed.

1. Go through the menu as follows: Apps menu / "Vehicle" / "Interior lighting" / "Ambient lighting" / "Lighting effects".
2. Select the desired setting.

Reduced lighting when driving at night

Some lights of the interior lighting are reduced when the vehicle is driven in the dark.

To activate/deactivate this function, go through the menu as follows: Apps menu /

"Vehicle" / "Interior lighting" / "Ambient lighting" / "Reduced for night driving".

Window wiper system

Principle

The wiper system makes sure that you have a clear view, e.g., in the rain. It is operated using the wiper lever on the steering wheel.

Safety information

Warning

If the wipers start moving in the folded away state, body parts can be jammed or damage may occur to parts of the vehicle. There is a risk of injury or risk of damage to property. Make sure that the vehicle is switched off when the wipers are in the folded-away state and the wipers are folded in when switching on.

NOTICE

The wiper blades can wear out or become damaged prematurely when wiping on a dry window for a longer period of time. The wiper motor can overheat. There is a risk of damage to property. Do not use the wipers when the window is dry.

NOTICE

If the wipers are frozen to the windshield, the wiper blades can be torn off and the wiper motor can overheat when switching on. There is a risk of damage to property. Defrost the windshield prior to switching the wipers on.

Turning on window wiper system

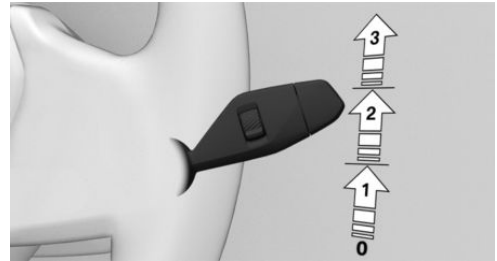

To turn on the wiper system, push the wiper lever upward to the desired position.

Position	Function
Position 0.	Rest position of wipers.
Position 1.	Rain sensor mode.
Position 2.	Normal wiper speed.
Position 3.	Fast wiper speed.

When you continue driving after stopping with the window wiper system on, the wipers will operate at the previous setting.

Turning off the window wiper system and flick wipe

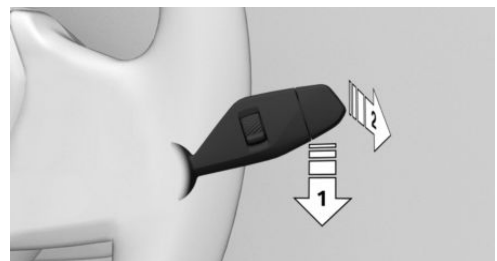

To turn off the wipers or to activate flick wiping, proceed as follows:

- To turn off: Push the wiper lever downward, arrow 1, until position 0 is reached.
- To flick wipe: Push the wiper lever downward from position 0, arrow 1, and

push the wiper lever forward to position 0 or position 1, arrow 2.

The wiper lever returns to its initial position when released.

Rain sensor

Principle

The rain sensor automatically controls the wiper operation depending on the intensity of the rainfall. The sensor is located on the windshield, directly in front of the interior mirror.

Safety information

NOTICE

If the rain sensor is activated, the wipers can accidentally start moving in car washes. There is a risk of damage to property. Deactivate the rain sensor in car washes.

Deactivating rain sensor

To deactivate the rain sensor: Push the wiper lever back to position 0.

Adjusting the rain sensor sensitivity

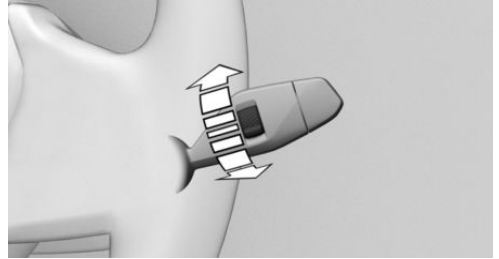

To adjust the sensitivity of the rain sensor, turn the knurled wheel on the wiper lever as follows:

- To set the rain sensor sensitivity to high, turn the knurled wheel up.
- To set the rain sensor sensitivity to low, turn the knurled wheel down.

Window washer system

Safety information

Warning

The washer fluid can freeze onto the window at low temperatures and obstruct the view. There is a risk of accident. Only use the window washer system when the washer fluid will not freeze. Use washer fluid with antifreeze, if needed.

NOTICE

When the washer fluid reservoir is empty, the washer pump cannot work as intended. There is a risk of damage to property. Do not use the washer system when the washer fluid reservoir is empty.

Activating rain sensor

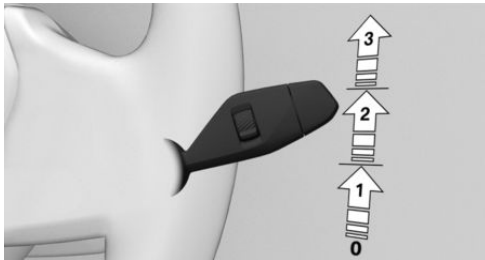

To activate the rain sensor: Push the wiper lever upward from position 0, arrow 1, once.

Wiping operation is started.

The LED in the wiper lever is illuminated.

In frosty conditions, wiping operation may not start.

Cleaning the windshield

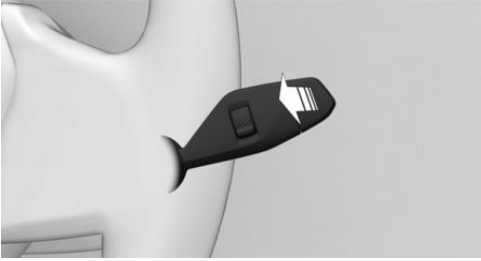

To clean the windshield, pull the wiper lever back.

The washer fluid is sprayed on the windshield, and the wipers are turned on briefly.

Windshield washer nozzles

The windshield washer nozzles are automatically heated while standby state is switched on.

Rear wiper

Switching on the rear wiper

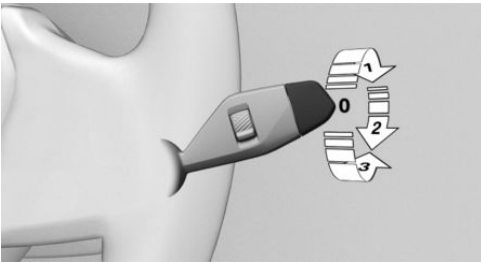

To turn on the rear wiper, rotate the outer switch on the wiper lever upward.

Switch position	Function
Position 0.	Rest position of the wiper.
Position 1.	Intermittent operation. When reverse gear is engaged, the system switches to continuous operation.

Clean the rear window

To clean the rear window, turn the outer switch on the wiper lever as follows:

- In rest position: Turn the switch downward, arrow 3. The switch returns to its rest position when released.
- In intermittent operation: Turn the switch further, arrow 2. The switch automatically returns to its interval position when released.

The function is deactivated if the washer fluid reservoir fill level is low.

Fold-out position of the wipers

Principle

In the fold-out position, the wipers can be folded out from the windshield, which is important, for instance, when changing the wiper blades or for folding away under frosty conditions.

Safety information

Warning

If the wipers start moving in the folded away state, body parts can be jammed or damage may occur to parts of the vehicle. There is a risk of injury or risk of damage to property. Make sure that the vehicle is switched off when the wipers are in

the folded-away state and the wipers are folded in when switching on.

⚠ NOTICE

If the wipers are frozen to the windshield, the wiper blades can be torn off and the wiper motor can overheat when switching on. There is a risk of damage to property. Defrost the windshield prior to switching the wipers on.

Folding in the wipers

To fold in the wipers, proceed as follows:

1. Fold the wipers back in toward the windshield.
2. Turn on standby state, then press the wiper lever down or forward again and hold it.

The wipers return to their rest position and are ready for operation.

Folding out the wipers

To fold the wipers away from the windshield, proceed as follows:

1. Activate standby state.
2. Push the wiper lever down or forward and hold it until the wipers stop in an approximately vertical position.

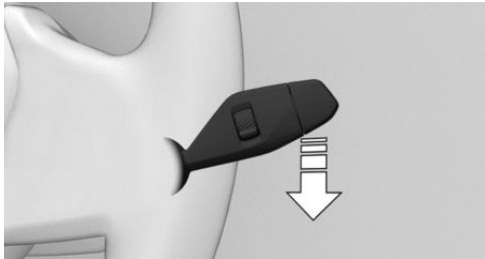

3. Fold the wipers all the way out from the windshield.



Safety

Vehicle features and options

This chapter describes model-specific equipment, systems, and functions that are currently available, or may become available in the future, even if they are not present in the vehicle.

Additional information:

Vehicle equipment, refer to page 8.

Airbags

Principle

The airbag system provides additional protection in the event of an accident, especially if the seat belt is worn correctly.

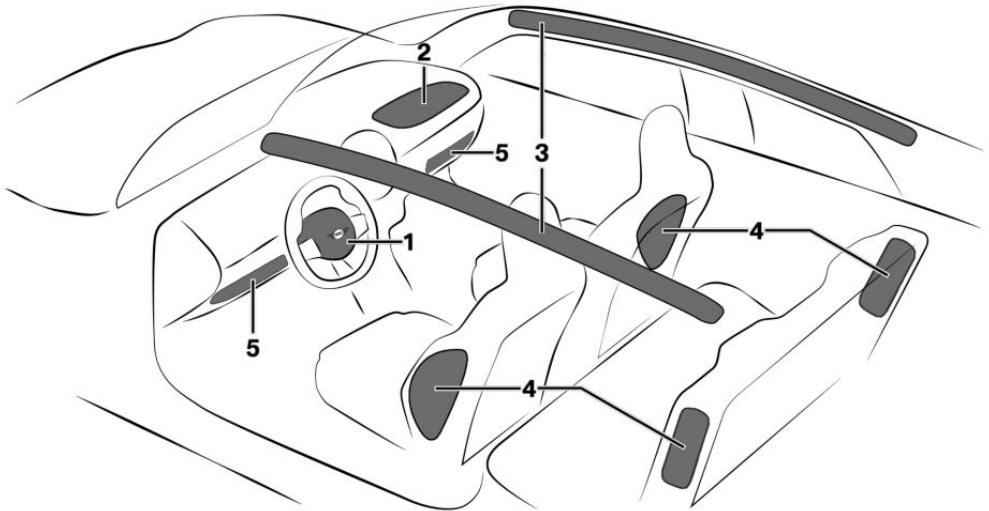

- | | |
|---------------------------------|---------------|
| 1 Front airbag, driver | 4 Side airbag |
| 2 Front airbag, front passenger | 5 Knee airbag |
| 3 Head airbag | |

Front airbags

The front airbag helps protect the driver and front passenger in the event of a frontal impact in which the seat belts alone would not provide adequate protection.

Side airbag

In the event of a side collision, the side airbag protects the side of the body in the chest and lap area.

Depending on national-market version: In the event of a side collision, the side airbag



in the rear protects the side chest and pelvic area of occupants in the outer rear seats.

Head airbag

In the event of a side collision, the head airbag protects the head.

Ejection Mitigation

The head airbag system is designed as an ejection mitigation countermeasure to reduce the likelihood of ejections of vehicle occupants through side windows during rollovers or side collision events.

Knee airbag

Depending on national-market version, the knee airbag protects occupants' legs in the event of a frontal collision.

Protective effect

General information

Airbags are not deployed in every impact situation, e.g., in less severe accidents.

Information on optimum protective effect of the airbags

Warning

If the seat position is incorrect, the seat belts are fastened incorrectly or the deployment area of the airbags is impaired, the airbag system cannot provide protection as intended and may cause additional injuries due to deployment. There is a risk of injury or danger to life. Follow the information on achieving the optimum protective effect of the airbag system.

To ensure that the airbag system has the optimal protective effect, note the following:

- Keep a distance from the airbags.
- Fasten seat belts correctly.
- Always grasp the steering wheel on the steering wheel rim. Hold hands at the 3 o'clock and 9 o'clock positions to keep the risk of injuring hands or arms as low as possible when the airbag deploys.
- Adjust seat and steering wheel so that hands can cross over the steering wheel. Select the settings so that the shoulder rests against the backrest when crossing the hands and the upper body is as far back as possible while still maintaining a comfortable grip on the steering wheel.
- Make sure that the front passenger is sitting correctly, i.e., with their feet and legs in the footwell, not resting on the dashboard.
- Make sure that occupants keep their heads away from the side airbag.
- There should be no additional persons, animals or objects between an airbag and a person.
- Keep the dashboard and windshield on the passenger's side clear, i.e., do not cover with adhesive film or other coating, and do not attach mounts for, e.g., navigation devices or mobile phones.
- Do not bond the airbag cover panels with adhesive, do not cover them, and do not modify them in any way.
- Do not use the front passenger's side airbag cover for storage.
- Keep storage compartments near the airbags closed, e.g., glove compartment or center armrest.
- Do not place slip covers, seat cushions, or other objects on the front seats unless they are specifically designed for seats with integrated airbags.
- Do not hang pieces of clothing such as jackets over the backrests.

- Do not modify individual components or wiring. This also applies to the dashboard, steering wheel covers, and seats.
- Do not disassemble the airbag system.

Even when you follow all instructions very closely, injury from contact with the airbags cannot be fully ruled out in certain situations.

The ignition and inflation noise may lead to short-term and, in most cases, temporary hearing impairment in sensitive occupants. Vehicle modifications for a person with disabilities may affect the air bag system; contact MINI Customer Relations for further information.

Warnings and information on the airbags are also found on the sun visors.

Operational readiness of the airbag system

Safety information

Warning

Individual components can be hot after deployment of the airbag system. There is a risk of injury. Do not touch individual components.

Warning

Improperly executed work can lead to failure, malfunction or unintentional deployment of the airbag system. In the case of a malfunction, the airbag system might not deploy as intended despite the accident severity. There is a risk of injury or danger to life. Have the airbag system checked, repaired, disassembled, and scrapped by an authorized service center or another qualified service center or repair shop.

Interaction Unit view



The airbag system warning light on the Interaction Unit illuminates briefly when drive-ready state is turned on, thus indicating the operational readiness of the entire airbag system and seat belt tensioners.

Malfunction



- The airbag system warning light on the Interaction Unit does not illuminate when drive-ready state is turned on.
- The airbag system warning light on the Interaction Unit illuminates continuously.

The airbag system or the seat belt tensioners may not be operational. Have the vehicle checked immediately by an authorized service center or another qualified service center or repair shop.

Setting the front seat positions

The power that deploys the driver's/front passenger airbags depends on the position of the driver's/front passenger seat.

To maintain the accuracy of this function, calibrate the electrical front seats as soon as the respective message appears on the Interaction Unit.

Additional information:

Seats, refer to page 94.

Deactivating the front passenger airbag automatically

Principle

The automatic front passenger airbag deactivation system can detect if the front passenger seat is occupied.



The front passenger airbag is activated or deactivated accordingly.

Safety information

Warning

To ensure the front passenger airbag function, the system must be able to detect whether a person is sitting in the front passenger seat. The entire seat surface must be used for this purpose. There is a risk of injury or danger to life. Make sure that the front passenger keeps his or her feet in the footwell.

Functional requirements

To ensure that occupants on the front passenger seat are detected properly, the following functional requirements apply:

- Do not attach covers, cushions, ball mats or other items to the front passenger seat unless they are specifically determined to be safe for use on the front passenger seat.
- Do not place objects under the seat that can press against the seat from below.
- Sit upright in the seat with the back against the backrest.
- Sit down with your feet touching the floor.

Installing child restraint systems

To ensure that occupants on the front passenger seat are detected properly, note the following:

- Pay attention to the specifications and the operating and safety information of the child restraint system manufacturer when using child restraint systems.
- Make sure that the seat surface of the child restraint system rests as flat as possible on the seat surface.

- Move the head restraint up or remove it to ensure that the child restraint system rests as flat as possible against the rear seat backrest.
- Observe the maximum size of the child restraint system, for example to avoid possible touching the roof.

Before transporting a child on the front passenger seat, refer to the safety information and instructions for children on the front passenger seat, see Children.

Additional information:

Install child restraint systems, refer to page 110.

Indicator light, front passenger airbag

The front passenger airbag indicator light in the headliner indicates the operating state of the front passenger airbag.

The indicator light shows whether the airbag is activated or deactivated.

After drive-ready state is turned on, the indicator light illuminates briefly and then shows whether the airbag is activated or deactivated.

Display	Function
	<p>The indicator light is continuously illuminated when the seat is not occupied or when a child is detected on the seat in a provided child restraint system as intended. The airbag on the front passenger's side is not activated.</p> <p>The indicator light does not illuminate when, for instance, a correctly seated person of sufficient size is detected on the seat. The airbag on the front passenger's side is activated.</p>

When the front passenger seat is occupied, check the indicator light in the headliner before and while driving.

Fault of the automatic deactivation system

For adolescents and adults, the front passenger airbag may deactivate in certain seat positions. In this case, the indicator light for the front passenger airbag illuminates in the headliner.

In this case, change the seat position so that the front passenger airbag activates and the indicator light goes out.

If it is not possible to activate the airbags, have the person sit in the rear seat.

Occupancy detection

The occupant detection system satisfies the legal requirements of Federal Motor Vehicle Safety Standard FMVSS 208 and deactivates the front passenger airbag under certain conditions.

Collision warning systems

Principle

The Intelligent Safety systems can help prevent an impending collision. To do so, the area around the vehicle is monitored by various sensors.

Depending on vehicle equipment, various safety and warning systems are available:

- Forward Collision Mitigation with brake intervention, refer to page 167.
- The exit warning, refer to page 176.
- The Lane Departure Warning, refer to page 178.
- The Lane Change Warning, refer to page 182.
- The rear-collision warning, refer to page 184.

The Intelligent Safety systems can be activated or deactivated on the Interaction Unit. Some functions, e.g., warning times, can be configured.

Safety information

Warning

The system cannot serve as a substitute for the driver's personal judgment in assessing the traffic situation. Based on the limits of the system, it cannot independently react to all traffic situations. There is a risk of accident, injury, or property damage. Adjust driving style to traffic conditions. Watch the surrounding traffic situation closely, be ready to take over steering and braking at any time, and actively intervene where appropriate.

**⚠ Warning**

Indicators and warnings cannot serve as a substitute for the driver's personal judgment. Due to its limits, the system may not issue warnings or responses, or these may be issued late or in a manner that is not consistent with their normal use. There is a risk of accident, injury, or property damage. Adjust driving style to traffic conditions. Watch surrounding traffic closely and actively intervene where appropriate

Sensors

Depending on vehicle equipment, the Intelligent Safety systems are controlled by the following sensors:

- Camera behind the windshield.
- Front radar sensor.
- Side radar sensors, rear.

Additional information:

Sensors of the vehicle, refer to page 34.

Activating/deactivating/adjusting Intelligent Safety systems

1. To activate/deactivate Intelligent Safety systems or configure settings, go through the menu as follows: Apps menu / "Vehicle" / "Driving settings" / "Driver Assistance" / "Safety and warnings".
2. Select the desired settings.

Depending on national-market version, some Intelligent Safety Systems are automatically activated whenever you start driving.

Resetting the settings

The settings of the collision warning systems can be reset to the default settings at vehicle outbound delivery.

Go through the menu as follows:
Apps menu / "Vehicle" / "Driving settings" / "Driver Assistance" / "Safety and warnings" / "Reset".

System limits**Safety information****⚠ Warning**

Because of system limitations, this system may either not respond, or respond too late, incorrectly, or without cause. There is a risk of accident, injury, or property damage. Actively intervene as warranted. Refer to the information in this Owner's Manual regarding the scope of the system's operation and limitations.

Detection capability

The detection capability of the collision warning systems is limited.

The system only takes into account objects that are located in the detection range of the installed sensors and are detected by the system.

Depending on the vehicle equipment, the area is monitored by cameras or radar sensors. Thus, a system response might not come or might come late.

System limits of the sensors

The Intelligent Safety systems may be restricted by the system limits of the sensors.

Additional information:

Sensors of the vehicle, refer to page 34.

Forward Collision Mitigation with brake intervention

Principle

Forward Collision Mitigation with brake intervention can help to prevent accidents within a certain speed range. To do so, the area around the vehicle is monitored by various sensors.

If an accident cannot be avoided, the system can help reduce the severity of the accident. The system can issue a warning of a possible risk of collision and activate the brakes independently, if needed. You can cancel automatic brake intervention manually, e.g., by actively moving the steering wheel.

Depending on vehicle equipment, the Forward Collision Mitigation system includes the following functions:

- The Rear-end collision warning function, refer to page 170.
- The oncoming traffic warning function, refer to page 171.
- The oncoming traffic warning function when turning, refer to page 172.
- The pedestrian warning function, refer to page 173.
- The intersection warning function, refer to page 174.
- The Evasion Assistant, refer to page 175.

Forward Collision Mitigation can be activated or deactivated using the Interaction Unit. You can also configure the warning time. Various indicator lights and warning lights are displayed on the Interaction Unit depending on the collision risk detected.

Safety information

Warning

The system cannot serve as a substitute for the driver's personal judgment in assessing the traffic situation. Based on the limits of the system, it cannot independently react to all traffic situations. There is a risk of accident, injury, or property damage. Adjust driving style to traffic conditions. Watch the surrounding traffic situation closely, be ready to take over steering and braking at any time, and actively intervene where appropriate.

Warning

Indicators and warnings cannot serve as a substitute for the driver's personal judgment. Due to its limits, the system may not issue warnings or responses, or these may be issued late or in a manner that is not consistent with their normal use. There is a risk of accident, injury, or property damage. Adjust driving style to traffic conditions. Watch surrounding traffic closely and actively intervene where appropriate.

Sensors

Depending on vehicle equipment, the Forward Collision Mitigation system is controlled by the following sensors:

- Camera behind the windshield.
- Front radar sensor.

Additional information:

Sensors of the vehicle, refer to page 34.

Speed range

The Forward Collision Mitigation system issues a warning for a possible risk of collision at speeds above approx. 3 mph/5 km/h.

If the vehicle speed exceeds approx. 155 mph/250 km/h, the system is deactivated temporarily.

Some functions are deactivated earlier.

The system is enabled as soon as the speed drops below this value again.

Activating/deactivating the Forward Collision Mitigation

Automatic activation of system

Depending on national-market version, the Forward Collision Mitigation is automatically activated whenever you start driving.

Activating the system manually

The Forward Collision Mitigation is activated by setting the warning time.

Additional information:

Set the warning time for Forward Collision Mitigation, refer to page 168.

Deactivating the system manually

Depending on national-market version, you must significantly reduce your vehicle's speed or stop your vehicle in order to deactivate the Forward Collision Mitigation manually. Forward Collision Mitigation is deactivated on the Interaction Unit.

It may be necessary to successively confirm this deactivation on the Interaction Unit.

Go through the menu as follows:

Apps menu / "Vehicle" / "Driving settings" / "Driver Assistance" / "Safety and warnings" / "Forward Collision Mitigation" / "Off".

Setting the warning time for Forward Collision Mitigation





You can configure the warning time at which Forward Collision Mitigation should issue a warning.

1. Go through the menu as follows:
Apps menu / "Vehicle" / "Driving settings" / "Driver Assistance" / "Safety and warnings" / "Forward Collision Mitigation".
2. Select the desired setting.

The more sensitive the warning time is set to be, the more warnings will be displayed. The system can therefore also issue more early or unfounded warnings and reactions.

Interaction Unit view

Forward Collision Mitigation is shown on the Interaction Unit and, depending on vehicle equipment, Head-up display by the following indicator lights and warning lights:

Icon	Meaning
	Risk of collision with a person, e.g., a pedestrian.
	Risk of collision, for instance with an oncoming or a vehicle driving ahead.
	Risk of collision, e.g., with a vehicle crossing from the right.
	Risk of collision, e.g., with a vehicle crossing from the left.
	General risk of collision.

Indicator lights and warning lights may be displayed differently since the system has detected multiple objects.

Warning function

The Forward Collision Mitigation warns on different warning levels, depending on the respective hazardous situation.

In the event of a prewarning, a warning light illuminates red. In the event of an acute warning, a warning light flashes red and a warning tone sounds.

In the event of a system warning, the driver must intervene immediately and in accordance with the situation.

- Red warning light illuminates:
A hazardous situation has been detected. Increased awareness is required.
- Red warning light flashes:
There is a risk of collision. Intervene immediately.
- A warning signal sounds:
There is a risk of collision. Intervene immediately.
- Automatic brake intervention:
Depending on the equipment and situation in case of risk of imminent collision, the system can also intervene with an automatic brake intervention and automatically decelerate the vehicle, if necessary, to a complete stop.

When the brake pedal is depressed quickly and hard, the maximum brake power of the vehicle is used.

Automatic brake intervention

If there is a risk of collision, the Forward Collision Mitigation system can assist with an automatic brake intervention, if necessary.

When the vehicle is traveling at a low speed, the vehicle may come to a complete stop.

A brake intervention can be canceled by depressing the accelerator pedal with suffi-

cient force, releasing the brake pedal, or by actively steering.

Depending on the equipment and situation, the brake intervention can occur up to approx. 155 mph/250 km/h.

At speeds above approx. 130 mph/210 km/h, only a brief brake intervention will occur.

System limits

Safety information

Warning

Because of system limitations, this system may either not respond, or respond too late, incorrectly, or without cause. There is a risk of accident, injury, or property damage. Actively intervene as warranted. Refer to the information in this Owner's Manual regarding the scope of the system's operation and limitations.

Detection capability

The detection capability of the Forward Collision Mitigation is restricted.

The system only takes into account objects that are located in the detection range of the installed sensors and are detected by the system.

Depending on the vehicle equipment, the area is monitored by cameras or radar sensors. Thus, a system response might not come or might come late.

System limits of the sensors

Forward Collision Mitigation may be restricted by the system limits of the sensors.

Additional information:

Sensors of the vehicle, refer to page 34.

Functional limitations

The Forward Collision Mitigation system may be limited in the following situations:

- In tight curves.
- With limitation of the driving stability control systems.
- Up to 10 seconds after drive-ready state is turned on via the Start/Stop switch.

Also, do not use Forward Collision Mitigation when towing.

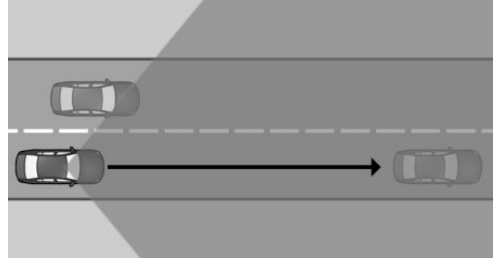

The sensors detect the traffic situation in their detection range.

Warning function in rear-end collision situations

Principle

To warn the driver of a possible risk of collision, the Rear Collision Warning function displays a warning light on the Interaction Unit and brakes automatically when necessary. You can cancel automatic brake intervention manually, e.g., by actively moving the steering wheel.

In the event of an accident, the system helps by reducing impact speed.

The time of warnings may vary depending on the current driving situation.

The system considers the driver's vehicle handling when responding. If an active driving style is detected, warnings and brake interventions occur less frequently.

Safety information



Follow the safety information in Chapter "Forward Collision Mitigation".

Speed range

The rear-end collision warning function is activated when your vehicle speed is greater than approx. 3 mph/5 km/h.

Interaction Unit view

If there is a risk of collision with a detected vehicle, a warning light is shown on the Interaction Unit and Head-up display, depending on vehicle equipment.

Icon	Meaning
	Forward Collision Warning with a detected vehicle.
	General risk of collision.

Warning function

The rear-end collision warning function issues warnings on different levels, depending on the respective hazard situation. This system prompts the driver to intervene manually.

Additional information:

Forward Collision Mitigation, refer to page 167.

System limits

General information

Follow the system limits in the "Forward Collision Mitigation" chapter.

Detection range

With the rear-end collision warning function, the following may not be detected or may be detected only with a delay in the detection range of the sensors, e.g.:

- Preceding vehicle driving slowly and being approached at high speed.
- Vehicles that suddenly swerve in front of you, or strongly decelerating vehicles.
- Vehicles with unusual rear designs.

Warning function for oncoming traffic

Principle

To warn the driver of a possible risk of collision with oncoming traffic, the Oncoming Traffic Warning function displays a warning light on the Interaction Unit and brakes automatically when necessary. You can cancel automatic brake intervention manually, e.g., by actively moving the steering wheel.

In the event of an accident, the system helps by reducing impact speed.

The time of warnings may vary depending on the current driving situation.

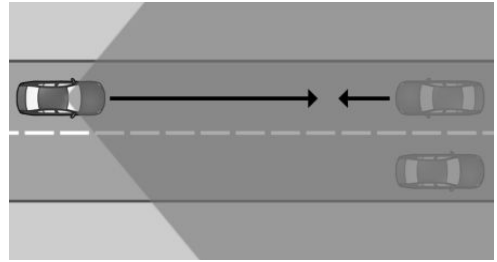

The sensors detect the traffic situation in their detection range.

Safety information



Follow the safety information in Chapter "Forward Collision Mitigation".

Speed range

The oncoming traffic warning is activated when your vehicle speed is greater than approx. 3 mph/5 km/h.

Interaction Unit view

If there is a risk of collision with a detected vehicle, a warning light is shown on the Interaction Unit and Head-up display, depending on vehicle equipment.

Icon	Meaning
	Oncoming traffic warning when a vehicle is detected.
	General risk of collision.

Warning function

The oncoming traffic warning function issues warnings on different levels, depending on the respective hazard situation. This system prompts the driver to intervene manually.

In case of a possible risk of collision, a brake intervention is triggered.

Additional information:

Forward Collision Mitigation, refer to page 167.

System limits

General information

Follow the system limits in the "Forward Collision Mitigation" chapter.

Detection range

With the oncoming traffic warning function, the following may not be detected or may be detected only with a delay in the detection range of the sensors, e.g.:

- Oncoming vehicles at a very high speed.
- Vehicles with an unusual front view.

Warning function for turning with oncoming traffic

Principle

To warn the driver of a possible risk of collision with oncoming traffic when turning, the Oncoming Traffic Warning function displays a warning light on the Interaction Unit and brakes automatically when necessary. You can cancel automatic brake intervention manually, e.g., by actively moving the steering wheel.

In the event of an accident, the system helps by reducing impact speed.

The time of warnings may vary depending on the current driving situation.

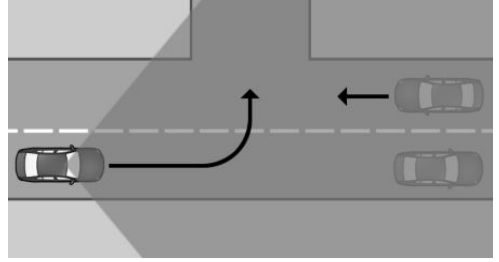

The sensors detect the traffic situation in their detection range.

Safety information

Follow the safety information in Chapter "Forward Collision Mitigation".



Speed range

The warning function for turning is activated when your vehicle speed is greater than approx. 3 mph/5 km/h.

This system reacts when your vehicle speed is less than approx. 15 mph/25 km/h.

Interaction Unit view

If there is a risk of collision with a detected vehicle, a warning light is shown on the Interaction Unit and Head-up display, depending on vehicle equipment.

Icon	Meaning
	Oncoming traffic warning when a vehicle is detected.
	General risk of collision.

Warning function

The warning function for turning with oncoming traffic issues warnings on different levels, depending on the respective hazard. This system prompts the driver to intervene manually.

Additional information:

Forward Collision Mitigation, refer to page 167.

System limits

General information

Follow the system limits in the "Forward Collision Mitigation" chapter.

Detection range

With the warning function for turning with oncoming traffic, the following may not be detected or may be detected only with a delay in the detection range of the sensors, e.g.:

- Oncoming vehicles at a very high speed.
- Vehicles that are hidden by other vehicles.
- Vehicles with an unusual front view.

Warning function for pedestrians

Principle

To warn the driver of a possible risk of collision with a pedestrian, the Pedestrian Warning function displays a warning light on the Interaction Unit and brakes automatically when necessary. You can cancel automatic brake intervention manually, e.g., by actively moving the steering wheel.

The system issues warnings for speeds that are common in towns and cities.

In the event of an accident, the system helps by reducing impact speed.

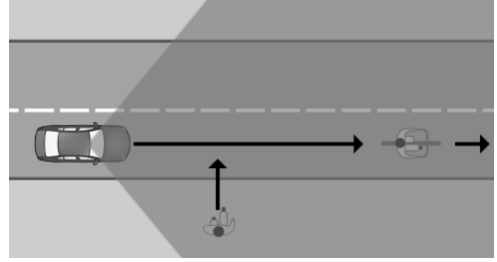

The sensors detect the traffic situation in their detection range on a straight road.

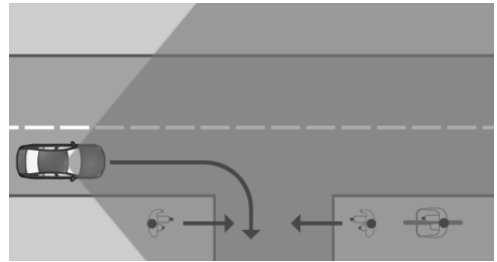

In addition, the sensors detect the traffic situation in their detection range when turning.

Safety information

Follow the safety information in Chapter "Forward Collision Mitigation".



Speed range

The Pedestrian Warning function is activated when your vehicle speed is greater than approx. 3 mph/5 km/h.

Depending on vehicle equipment, this system reacts when your vehicle speed is less than approx. 50 mph/80 km/h.

Interaction Unit view

If there is a risk of collision with a detected pedestrian or cyclist, a warning light is shown on the Interaction Unit and Head-up display, depending on vehicle equipment.

Icon	Meaning
	Risk of collision with a person, e.g., a pedestrian.
	General risk of collision.

- Partially covered pedestrians or bikes.
- Pedestrians that are not detected as such because of their contour or posture.
- Pedestrians who are too small for the sensors to detect.

Warning function

The Pedestrian Warning system issues warnings on different levels, depending on the respective hazard situation. This system prompts the driver to intervene manually.

Additional information:

Forward Collision Mitigation, refer to page 167.

System limits

General information

Follow the system limits in the "Forward Collision Mitigation" chapter.

Detection range

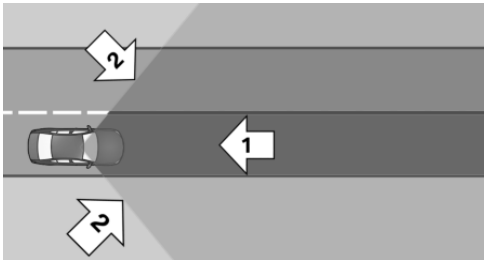

With the Pedestrian Warning, the sensor detection range consists of the following:

- From the middle area directly in front of vehicle, arrow 1.
- From the enlarged area to the right and left of the middle area, arrows 2.

The following situations may not be detected, for instance:

Warning function at intersections

Principle

To warn the driver of a possible risk of collision with crossing traffic, the Intersection Warning function displays a warning light on the Interaction Unit and brakes automatically when necessary. You can cancel automatic brake intervention manually, e.g., by actively moving the steering wheel.

At intersections and junctions, this system issues warnings for speeds that are common in towns and cities.

In the event of an accident, the system helps by reducing impact speed.

The time of warnings may vary depending on the current driving situation.

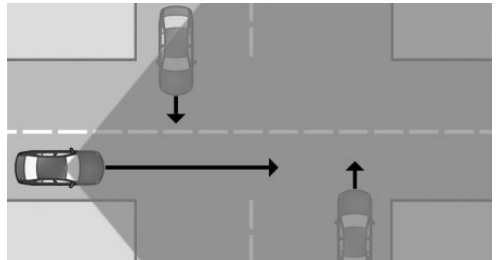

The sensors detect the traffic situation in their detection range.

Vehicles crossing your driving direction can be detected by the system as soon as these vehicles enter into detection range of the sensors.

Safety information

Follow the safety information in Chapter "Forward Collision Mitigation".



Speed range

The Intersection Warning is activated when your vehicle speed is greater than approx. 3 mph/5 km/h.

The system responds to crossing vehicles when the vehicle speed is below approx. 50 mph/80 km/h.

Interaction Unit view

If there is a risk of collision with a detected vehicle, a warning light is shown on the Interaction Unit and Head-up display, depending on vehicle equipment.

Icon	Meaning
	Risk of collision with vehicle crossing from the right.
	Risk of collision with vehicle crossing from the left.
	General risk of collision.

Warning function

The Intersection Warning system issues warnings on different levels, depending on the respective hazard. This system prompts the driver to intervene manually.

Additional information:

Forward Collision Mitigation, refer to page 167.

System limits

General information

Follow the system limits in the "Forward Collision Mitigation" chapter.

Detection range

With the Intersection Warning function, the following may not be detected or may be detected only with a delay in the detection range of the sensors, e.g.:

- Crossing vehicles when they are hidden, e.g. by buildings.
- Vehicles with an unusual side view.
- Vehicles in highly dynamic driving situations.

Evasion Assistant

Principle

The Evasion Assistant can help the driver perform evasive maneuvers in certain situations, e.g., when obstacles or pedestrians appear suddenly. This system intervenes actively to assist the driver if it is possible to make an evasive maneuver to the side.

If the system detects sufficient free space alongside the vehicle, it helps the driver perform an evasive maneuver safely.

This system warns the driver of a possible risk of collision by displaying various warning lights on the Interaction Unit.

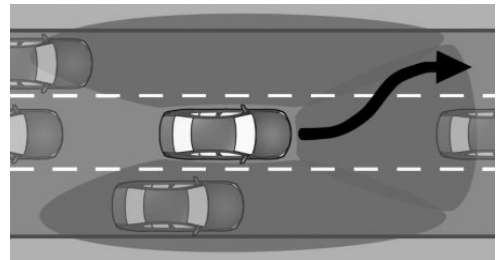

The sensors monitor and detect the clearance in front of the vehicle. Depending on the vehicle equipment, the areas next to the vehicle are also monitored.

Safety information

Follow the safety information in Chapter "Forward Collision Mitigation".

Functional requirements

The following functional requirements apply for the Evasion Assistant:



- Forward Collision Mitigation is active.
- Sensors have detected sufficient clearance around the vehicle.

Speed range

The Evasion Assistant helps the driver when the vehicle speed is between approx. 19 mph/30 km/h to 100 mph/160 km/h.

Interaction Unit view

If there is a risk of collision with a detected vehicle or person, e.g., a pedestrian, a warning light is shown on the Interaction Unit and Head-up display, depending on vehicle equipment.

Icon	Meaning
	Warning when a vehicle is detected.
	Risk of collision with a pedestrian.
	Risk of collision with unknown obstacle.

Warning function with evasion support

If the vehicle approaches another object at a high differential speed, a warning is displayed if there is an immediate risk of collision.

Intervene in case of a warning.

The system is designed to provide assistance during evasive maneuvers when there is a risk of collision.

The Evasion Assistant is signaled by a message on the Interaction Unit and Head-up display, depending on vehicle equipment.

System limits

General information

Follow the system limits in the "Forward Collision Mitigation" chapter.

Detection range

With the Evasion Assistant, the following may not be detected in the sensor detection range, e.g.:

- Preceding vehicle driving slowly and being approached at high speed.
- Vehicles that suddenly swerve in front of you, or strongly decelerating vehicles.
- Vehicles with unusual rear designs.
- Two-wheeled vehicles ahead of you.
- Partially covered pedestrians or bikes.
- Pedestrians that are not detected as such because of their contour or posture.
- Pedestrians who are too small for the sensors to detect.

Exit warning

Principle

The exit warning helps to avoid accidents.

The system monitors the vehicle's surroundings for a limited time after you get in or park. When opening doors, vehicle occupants are then warned if a risk of collision with an approaching object is detected.

A possible risk of collision is indicated by various warnings, e.g., warning light on the exterior mirror and a warning tone.

The warning light in the exterior mirror gives warnings at different levels.

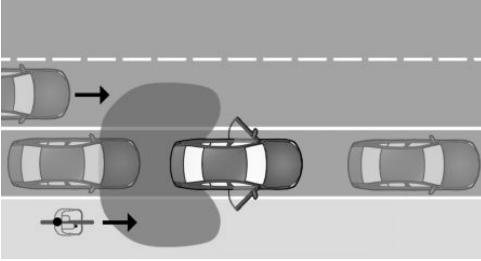

The sensors monitor the area behind the vehicle.

The exit warning can be activated or deactivated on the Interaction Unit. This warning function can also be configured.

Safety information

Follow the safety information in the "Forward Collision Mitigation" chapter.

Sensors

The Exit Warning is controlled by the side, rear radar sensors.

Activating/deactivating the exit warning

Automatic activation of system

The exit warning activates automatically whenever you start driving if this function was switched on when you completed your last trip.

Deactivating the system manually

To deactivate the Exit Warning, go through the menu as follows: Apps menu / "Vehicle" / "Driving settings" / "Driver

Assistance" / "Safety and warnings" / "Exit warning" / "Off".

Configuring the exit warning

1. To configure the Exit Warning, go through the menu as follows: Apps menu / "Vehicle" / "Driving settings" / "Driver Assistance" / "Safety and warnings" / "Exit warning".
2. Select the desired setting.

Turning the warning signal on/off

To turn the Exit Warning tone on/off, go through the menu as follows: Apps menu / "Vehicle" / "Driving settings" / "Driver Assistance" / "Safety and warnings" / "Exit warning" / "Warning tone".

Displays

Warning light in exterior mirror

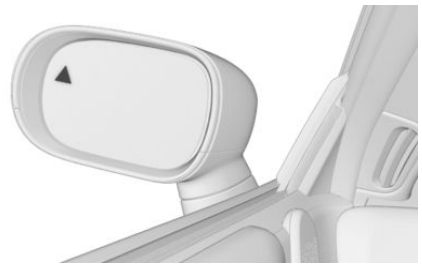

The warning light in the exterior mirror warns of a possible collision with a detected vehicle.

Ambient light

Depending on the equipment, warnings are also indicated by the ambient light in the interior.



Warning function

Prewarning

In the event of a prewarning for the Exit Warning, the warning light on the exterior mirror illuminates. Depending on the equipment, the ambient light also flashes.

An object was detected in the opening area of the doors. Increased awareness is required.

Acute warning

In the event of an acute Exit Warning, the warning light on the exterior mirror flashes, as does the ambient light, depending on vehicle equipment. In addition, a warning tone sounds.

There is a risk of collision when opening the doors.

System limits

General information

Follow the system limits in the "Collision warning systems" chapter.

Detection range

With the Exit Warning, the following may not be identified in the sensor detection range, e.g.:

- Fully or partially hidden objects.
- Stationary or very slow objects.
- Pedestrians.

Functional limitations

The exit warning system may be restricted in the following situations:

- The speed of an approaching vehicle is too fast or too slow.
- In curves.
- In case of fully or partially hidden objects.

Lane Departure Warning with active return

Principle

The Lane Departure Warning system with active return alerts the driver when their vehicle is about to leave the road or lane.

An automatic steering intervention helps to keep the vehicle in its lane.

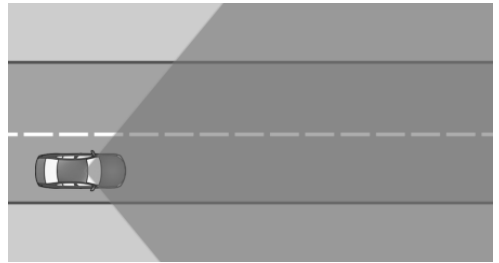

The sensors detect the traffic situation in their detection range.

The Lane Departure Warning can be activated, deactivated, and configured on the Interaction Unit.

Warnings are displayed on the Interaction Unit. In addition, the steering wheel vibrates at the set intensity.

If you set your turn signal for the corresponding direction before leaving your lane, no warnings are displayed.

Safety information

Warning

The system cannot serve as a substitute for the driver's personal judgment in assessing road and traffic situations. There is a risk of accident. Adjust driving style to traffic conditions. Watch surrounding traffic closely and actively intervene where

appropriate Do not jerk the steering wheel in response to a warning.

Warning

Indicators and warnings cannot serve as a substitute for the driver's personal judgment. Due to its limits, the system may not issue warnings or responses, or these may be issued late or in a manner that is not consistent with their normal use. There is a risk of accident, injury, or property damage. Adjust driving style to traffic conditions. Watch surrounding traffic closely and actively intervene where appropriate

Functional requirement

For the Lane Departure Warning to activate, the camera must detect the lane boundary.

Speed range

The Lane Departure Warning is activated when your vehicle exceeds a given minimum speed. The minimum speed is country-specific and displayed on the Interaction Unit.

Sensors

Depending on vehicle equipment, the Lane Departure Warning system is controlled by the following sensors:

- Camera behind the windshield.
- Front radar sensor.

Activating/deactivating the Lane Departure Warning

Automatic activation of system

Depending on national-market version, the system is automatically activated whenever you start driving.

Activating the system manually

The Lane Departure Warning is activated by setting the warning time.

Additional information:

Configuring the Lane Departure Warning, refer to page 179.

Deactivating the system manually

Depending on vehicle equipment and national-market version, deactivation of the Lane Departure Warning must be confirmed successively on the Interaction Unit.

Go through the menu as follows:

Apps menu / "Vehicle" / "Driving settings" / "Driver Assistance" / "Safety and warnings" / "Lane Departure Warning" / "Off".

Setting Lane Departure Warning

The Lane Departure Warning menu can be used to configure this function and specify when it should issue warnings.

1. Go through the menu as follows: Apps menu / "Vehicle" / "Driving settings" / "Driver Assistance" / "Safety and warnings" / "Lane Departure Warning".
2. Select the desired setting.

- "Enhanced"

If the system detects that your vehicle is about to leave your lane or cross a lane marking, a warning is issued. The system performs a steering intervention.

- "In dangerous situations"

A warning is issued if the system detects that the vehicle is about to inadvertently cross a lane marking, or if the sensors detect an oncoming vehicle. A steering intervention is performed.

Depending on national-market version, with continuous lane markings:



If the system detects that your vehicle is about to inadvertently leave your lane or cross a lane marking, a warning is issued. A steering intervention is performed.

Setting the intensity of the steering wheel vibration

1. To adjust the steering wheel vibration intensity, go through the menu as follows: Apps menu / "Vehicle" / "Driving settings" / "Driver Assistance" / "Feedback via steering wheel" / "Vibration intensity".
2. Select the desired setting.

The setting is applied to all collision warning systems.

Depending on national-market version: activate/deactivate steering intervention

Depending on national-market version, the Lane Departure Warning steering intervention can be activated or deactivated.

Go through the menu as follows: Apps menu / "Vehicle" / "Driving settings" / "Driver Assistance" / "Safety and warnings" / "Lane Departure Warning" / "Steering intervention".

Depending on the national-market version, the steering intervention is automatically active after every driving off.

Interaction Unit view

Depending on vehicle equipment and national-market version, different warnings for the Lane Departure Warning are displayed on the Interaction Unit.

Icon	Meaning
	Indicator light flashes green: System is performing a steering intervention.



Depending on vehicle equipment and national-market version, information for the system is shown in Assisted View on the Interaction Unit.

Additional information:

Assisted View, refer to page 145.

Warning function

If you leave the lane

If you leave the lane and if a lane boundary has been detected, the steering wheel vibrates in accordance with the steering wheel vibration setting.



In addition, the indicator light flashes green.

When the turn signal is switched on in the corresponding direction before changing the lane, a warning is not issued.

Steering intervention

Depending on vehicle equipment and national-market version: The Lane Departure Warning system may intervene with an active steering intervention in addition to vibration if you cross a lane marking at speeds up to 130 mph/210 km/h. The system supports the driver in keeping the vehicle within the lane. The steering intervention can be noticed on the steering wheel and can be manually overridden at any time.



When steering intervention is active, the indicator light flashes green.

For instance, the steering intervention will be suppressed in the following situations:

- With hard accelerating or braking.
- When flashing.
- With hazard warning system switched on.

- In driving situation with high driving dynamics.
- While Dynamic Stability Control regulates driving stability.
- While Dynamic Stability Control is limited.
- Immediately following a steering intervention by the vehicle systems.
- Immediately following a steering intervention by the vehicle systems.
- With manual steering intervention.
- When another driver assistance system is activated, if applicable.
- When no lane markings are detected.
- When the system limits are reached.

Warning signal

Depending on national-market version: An acoustic warning will sound if the Lane Departure Warning system performs multiple active steering interventions within 3 minutes and the driver does not operate the steering wheel themselves during the steering intervention(s). A short warning signal will sound at the second steering intervention. Beginning with the third steering intervention, a continuous warning will sound.

In addition, a Check Control message is displayed.

The warning tone and Check Control message advise the driver to pay closer attention to their lane.

The extended warning tone stops when the steering wheel is moved manually.

End of warning

The warning or active steering intervention will be canceled in the following situations, for example:

- Automatically after a few seconds.
- When returning to your own lane.
- With hard accelerating or braking.
- With hazard warning system switched on.
- When flashing.
- While Dynamic Stability Control regulates driving stability.

System limits

General information

Follow the system limits in the "Collision warning systems" chapter.

Functional limitations

The Lane Departure Warning system may be restricted in the following situations:

- In the event of missing, worn, poorly visible, merging, diverging, or multiple lane boundaries such as in construction areas.
- With lane boundaries that are covered in snow, ice, dirt or water.
- In tight corners or on narrow roads.
- With lane boundaries that are covered by objects.
- When driving very close to the vehicle in front of you.
- Up to 10 seconds after drive-ready state is turned on via the Start/Stop switch.
- While Dynamic Stability Control regulates driving stability.
- While Dynamic Stability Control is limited.

A Check Control message may be displayed when the system is limited. A yellow warning light also illuminates, depending on national-market version.

Active Blind Spot Detection with active return

Principle

The Lane Change Warning system with active return detects vehicles in your blind spot or vehicles approaching from behind in the adjacent lane.

An automatic steering intervention helps to keep the vehicle in its lane.

A possible risk of collision is indicated by various warnings, e.g., signaled by warning light on the exterior mirror.

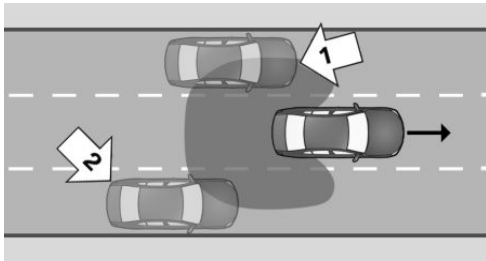

The sensors monitor the area behind and next to the vehicle.

The system indicates whether there are vehicles in your blind spot, arrow 1, or approaching from behind in an adjacent lane, arrow 2. The warning light in the exterior mirror illuminates dimly.

The system will warn in the previously named situations prior to a lane change. The warning light on the exterior mirror flashes and the steering wheel vibrates at the set intensity.

Active Blind Spot Detection can be activated, deactivated, and configured on the Interaction Unit.

Safety information

Follow the safety information in the "Forward Collision Mitigation" chapter.

Speed range

Active Blind Spot Detection is activated when your vehicle exceeds a given minimum speed. The minimum speed is country-specific and displayed in the Active Blind Spot Detection menu.

When turning at a speed of up to approx. 12 mph/20 km/h, the steering wheel will not vibrate.

This system is temporarily deactivated at speeds greater than approx. 155 mph/250 km/h.

If the vehicle speed falls below approx. 155 mph/250 km/h, the system is reactivated.

Sensors

Active Blind Spot Detection is controlled by the following sensors:

- Camera behind the windshield.
- Side radar sensors, rear.

Activating/deactivating the Lane Change Warning

1. To activate/deactivate Active Blind Spot Detection, go through the menu as follows: Apps menu / "Vehicle" / "Driving settings" / "Driver Assistance" / "Safety and warnings" / "Active Blind Spot Detection".
2. Select the desired setting.

Depending on vehicle equipment and national-market version, Active Blind Spot Detection activates automatically whenever you start driving.

Adjusting the Active Blind Spot Detection

1. To configure Active Blind Spot Detection, go through the menu as follows: Apps menu / "Vehicle" / "Driving settings" / "Driver Assistance" / "Safety

and warnings" / "Active Blind Spot Detection".

2. Select the desired setting.

You can configure how many warnings will be shown. However, there may also be an excess of unwarranted warnings of critical situations.

Setting the intensity of the steering wheel vibration

1. To adjust the steering wheel vibration intensity, go through the menu as follows: Apps menu / "Vehicle" / "Driving settings" / "Driver Assistance" / "Feedback via steering wheel" / "Vibration intensity".
2. Select the desired setting.

The setting is applied to all collision warning systems.

Depending on national-market version: activate/deactivate steering intervention

Depending on national-market version, the Lane Change Warning steering intervention can be activated or deactivated.

Go through the menu as follows:
Apps menu / "Vehicle" / "Driving settings" / "Driver Assistance" / "Safety and warnings" / "Active Blind Spot Detection" / "Steering intervention".

Warning function

Warning light in exterior mirror

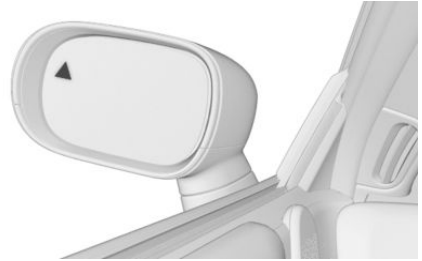

The warning light in the exterior mirror warns of a possible collision with a detected vehicle.

Prewarning

In the event of a prewarning for Active Blind Spot Detection, the dimmed warning light on the exterior mirror indicates when vehicles are in your blind spot or approaching from the rear.

Acute warning

When an acute warning is issued by Active Blind Spot Detection, the steering wheel vibrates briefly. The warning light in the exterior mirror flashes brightly.

An acute warning is issued if the following conditions are met:

- Another vehicle is located in the critical area.
- Your own vehicle is approaching the other lane.
- Depending on the system setting when the turn signal is turned on.

The warning stops when the other vehicle has left the critical area.

Steering intervention

Depending on national-market version:
The Active Blind Spot Detection system



may perform an active steering intervention when there is no response to the steering wheel vibration and a lane marking is crossed at speeds of up to 130 mph/210 km/h. The steering intervention helps return the vehicle into the lane. The steering intervention can be noticed on the steering wheel and can be manually overridden at any time.

The steering intervention is carried out from a minimum speed. This minimum speed is displayed on the Interaction Unit.

Warning light flashing

As a self-test of Active Blind Spot Detection, the warning light on the exterior mirror flashes briefly when the vehicle is unlocked.

System limits

General information

Follow the system limits in the "Collision warning systems" chapter.

Functional limitations

The Lane Change Warning system may be restricted in the following situations:

- When a vehicle is approaching at a speed much faster than your own.
- In tight corners or on narrow roads.
- The bumper is dirty, iced up or covered, for instance by stickers.

Depending on the national-market version, the steering intervention e.g. in the following situations:

- In the event of missing, worn, poorly visible, merging, diverging, or multiple lane boundaries such as in construction areas.
- With lane boundaries that are covered in snow, ice, dirt or water.

- With lane boundaries that are not white.
- With lane boundaries that are covered by objects.
- When driving very close to the vehicle in front of you.
- If the camera is impaired.
- Up to 10 seconds after drive-ready state is turned on via the Start/Stop switch.

A Check Control message may be displayed when the system is limited. A yellow warning light also illuminates, depending on national-market version.

Rear-end collision preparation

Principle

Depending on the equipment and national-market version, the rear-end collision preparation can react to vehicles approaching from behind.

Depending on the national-market version, the hazard warning flashers are switched on and PreCrash functions are triggered where applicable if a vehicle approaching at a certain speed is detected.

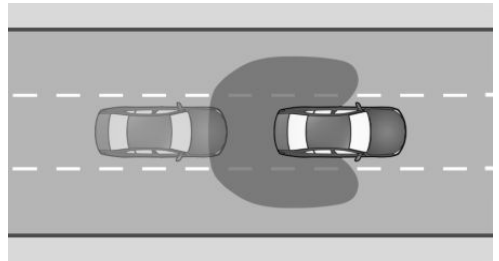

The sensors monitor the area behind the vehicle.

The rear-end collision preparation function is activated automatically when you start driving and is deactivated automatically in certain situations.

Safety information

Follow the safety information in the "Forward Collision Mitigation" chapter.

Sensors

The rear-end collision preparation function is controlled by the side, rear radar sensors.

Activating/deactivating the rear-collision warning

The rear-collision warning is automatically activated whenever you start driving.

The system is deactivated when reversing.

System limits

General information

Follow the system limits in the "Collision warning systems" chapter.

Functional limitations

The rear-collision warning may be restricted if the speed of the approaching vehicle is much higher or similar to your own speed.

Cross Traffic Warning with brake intervention

Principle

The Cross Traffic Warning with brake intervention helps the driver by providing visual and acoustic warnings when driving through confusing exits or pulling out of perpendicular parking spaces.

The system detects road users approaching from the side earlier than would be possible from the driver's seat.

If there is a risk of collision when reversing, this system provides assistance by performing an automatic brake intervention.

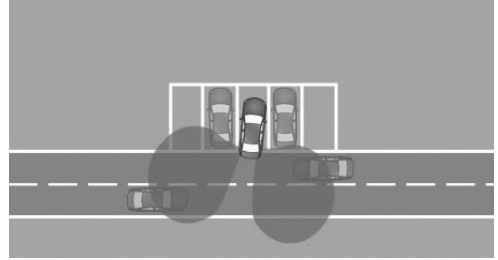

The sensors monitor the area behind the vehicle.

The system displays a warning light on the exterior mirror, for example, when other road users are approaching.

The cross traffic warning can be activated or deactivated on the Interaction Unit.

General information

Follow the information in the "Parking assistance systems" chapter.

Safety information

Warning

The system cannot serve as a substitute for the driver's personal judgment in assessing the traffic situation. Based on the limits of the system, it cannot independently react to all traffic situations. There is a risk of accident, injury, or property damage. Adjust driving style to traffic conditions. Watch the surrounding traffic situation closely, be ready to take over steering and braking at any time, and actively intervene where appropriate.

Sensors

The Cross Traffic Warning system is controlled by the side, rear radar sensors.

Activating/deactivating Cross Traffic Warning

The system must be activated on the Interaction Unit for the Cross Traffic Warning and brake intervention to switch on automatically.

1. Go through the menu as follows: Apps menu / "Vehicle" / "Driving settings" / "Driver Assistance" / "Parking".
2. Select the desired setting, depending on vehicle equipment:
 - "Rear warning"
 - "Brake intervention at rear"

Turning on the cross traffic warning automatically

The Cross Traffic Warning must be activated on the Interaction Unit. The system turns on automatically as soon as Park Distance Control or a camera view activates and you engage a gear position.

If reverse gear is engaged, the rear system is switched on.

Depending on the national-market version, the system is automatically active when the vehicle is started.

Turning off the cross traffic warning automatically

The Cross Traffic Warning switches off automatically in the following situations, for example:

- When walking speed is exceeded.
- When a certain distance covered is exceeded.

Warning function

General information

With the Cross Traffic Warning, the Interaction Unit displays the corresponding

view, an acoustic signal may sound, and the warning light on the exterior mirror flashes.

When a brake intervention is performed, a message displays on the Interaction Unit then closes after a short time.

Visual warning

Warning light in exterior mirror

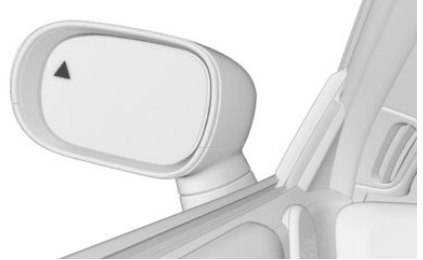

The warning light in the exterior mirror flashes if the rear sensors detect other vehicles when the vehicle is reversing.

Display in the Park Distance Control view

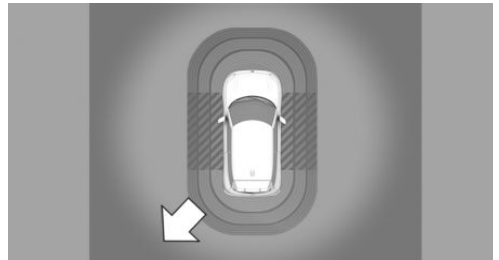

In the Park Distance Control view, the respective boundary area flashes red if vehicles are detected by the sensors.

Display in camera view

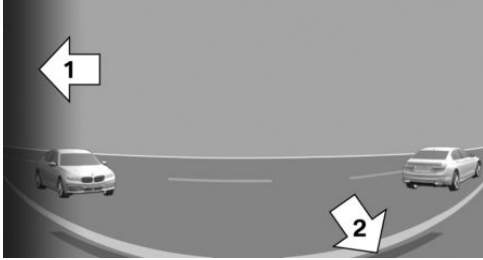

The respective boundary area, arrow 1, in the camera image flashes red if vehicles are detected by the sensors.

Yellow lines, arrow 2, mark the bumper of your own vehicle.

Acoustic warning

In addition to the visual warning of the Cross Traffic Warning function, an acoustic signal sounds if your vehicle moves in the corresponding direction.

Depending on the national-market version, the signal tone will already sound when the gear position is engaged.

System limits

System limits of the sensors

The Cross Traffic Warning may be restricted by the system limits of the sensors.

Additional information:

Sensors of the vehicle, refer to page 34.

Functional limitations

The Cross Traffic Warning system may be restricted in the following situations:

- In tight curves.
- Crossing objects are moving at a very slow or a very fast speed.
- Other objects that hide cross traffic are in the capture range of the sensors.

Drive Recorder

Principle

The Drive Recorder stores brief video recordings your vehicle's surroundings, e.g., to document surrounding traffic. To do so, the system must be activated on the Interaction Unit before using it for the first time.

The Interaction Unit can be used to configure video recording settings, e.g., recording type and duration.

Video recordings can be saved in different ways:

- Automatic storage of recordings makes it possible to document the vehicle accident or theft using the corresponding recording type configured.
- Saving recordings manually helps you document traffic situations using your set recording type.

Depending on vehicle equipment, video recordings can be saved directly to a mobile device, e.g., a smartphone or USB stick.

Assistance system cameras are used to record, e.g., panorama view cameras.

In addition, the following parameters are stored for the trip:

- Date.
- Time.
- Speed.
- GPS coordinates.

Data protection

The Drive Recorder is permitted to record and evaluate video recordings in accordance with applicable regulations of the country in which the system is to be used. The user is responsible for the use of the system and compliance with respective applicable regulations.



The vehicle manufacturer recommends that you verify there are no statutory or regulatory restrictions on using the system in your region or country prior to initial use. In addition, the laws with respect to use of the system should be verified in regular intervals, especially when borders are frequently crossed.

Other drivers of the vehicle must be informed about the system. In addition, you should inform others about the system when giving them the vehicle.

Functional requirements

The following functional requirements apply for the Drive Recorder:

- Standby or drive-ready state is switched on.
- The Drive Recorder is activated.
- The Privacy Policy has been accepted.
- The recording type has been selected.
- The recording duration has been selected.

The following functional requirements apply when using the theft alert:

- The theft notification was activated in the Data Protection menu or in the Drive Recorder menu.
- Data transfer is activated.
- The MINI app is installed on the mobile device.
- The MINI app is linked to the MINI Connected account.
- The Privacy Policy has been accepted.

Activating/deactivating the Drive Recorder

The Drive Recorder must be activated on the Interaction Unit before using the recording function for the first time.

1. Go to the Apps menu.
2. "All"
3. "Drive Recorder"
4. Accept the Privacy Policy.
5. "Settings"
6. "Allow recording"
7. Select the desired setting.

Recording functions

Starting/stopping an automatic recording

If the vehicle sensors detect an accident or theft, the Drive Recorder starts recording automatically and then saves this recording.

- In the event of an accident, the Drive Recorder saves recordings up to 30 seconds before and after storage is triggered.
- In the event of theft, the Drive Recorder saves recordings after being triggered. Recordings are stored depending on the setting selected for recording duration.

When the alarm system is triggered, a message is sent to the MINI app.

After saving the recording, the reduced quality video can be downloaded to a mobile device.

If the vehicle accelerates rapidly, an automatic recording may be taken.

Manual recording

Via the button

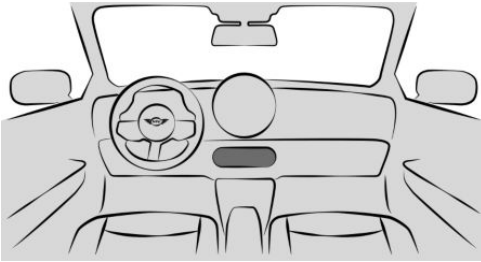

To start a manual recording with the Drive Recorder, press and hold the Park Assist key on the switch cluster.

Recordings are made for the set recording time or can be ended manually on the Interaction Unit.

Via the Interaction Unit

To start recording with Drive Recorder in the vehicle, go through the menu as follows: Apps menu / "All" / "Drive Recorder" / "Start recording" / "(vehicle)".

Recordings are made for the set recording time and can be stopped manually by reselecting the menu item on the Interaction Unit.

The system saves recordings up to 30 seconds before and after storage is triggered.

Recording playback and administration

Video recordings saved by the Drive Recorder can be played, exported, and deleted.

For your own safety, video recordings are only shown on the Interaction Unit if the vehicle speed is below approx. 2 mph/3 km/h. Depending on national-market version, video recordings are only

shown when the parking brake is applied or selector lever position P is engaged.

1. Go through the menu as follows: Apps menu / "All" / "Drive Recorder" / "Recordings".
2. Select the desired recording.
3. If necessary, select the camera.

Settings

Recording type

1. To select the recording type for Drive Recorder, go through the menu as follows: Apps menu / "All" / "Drive Recorder" / "Settings".
2. Select the desired setting.

Recording time

1. To configure the recording time for Drive Recorder, go through the menu as follows: Apps menu / "All" / "Drive Recorder" / "Settings".
2. Select the desired setting.

Recording on a mobile device

General information

The length of the video that can be stored depends on the available memory capacity on the mobile device.

Functional requirements

When recording on a mobile device, the following functional requirements apply for the Drive Recorder:

- The Privacy Policy has been accepted.
- The Drive Recorder is activated.

When sending recordings to a mobile device, the following functional requirements apply for the Drive Recorder:



- Depending on vehicle equipment, pair a mobile device with the vehicle via Wi-Fi and Bluetooth audio, or connect a USB stick.
- The MINI app is installed on the mobile device.
- The MINI app is linked to the MINI Connected account.
- The MINI app is permitted to access your photo library.

Starting/ending recording

To start recording with Drive Recorder on a mobile device, go through the menu as follows: Apps menu / "All" / "Drive Recorder" / "Start recording" / "(USB/MINI App)".

Recordings can be stopped manually by re-selecting the menu item on the Interaction Unit.

Cameras

Various Drive Recorder cameras can be selected.

1. Go through the menu as follows: Apps menu / "All" / "Drive Recorder" / "Settings" / "Camera selection".
2. Select your desired camera.

System limits

In the event of a serious accident, the Drive Recorder may not be able to store recordings if the damage to the vehicle is too great or the power supply was interrupted.

With USB sticks that have repeatedly been overwritten, it may only be possible to export recordings in a limited manner.

The preferred file system for USB storage is NTFS. Other file systems may have limitations.

In case of theft, the recording is only stored automatically when the anti-theft warning system has been triggered.

If the internet connection is weak or cannot be established, theft alerts and video downloads may be restricted or not available.

The quality of the Wi-Fi connection affects whether recordings can be saved on your smartphone. This function may be restricted or not available if the connection is weak.

Active Protection

Principle

Active Protection prepares occupants and the vehicle for a possible accident in critical driving situations.

Depending on vehicle equipment and national-market version, this system consists of various PreCrash functions.

Active Protection is used to detect certain critical driving situations that might lead to an accident. This includes the following critical driving situations:

- Emergency braking.
- Severe understeering.
- Severe oversteering.

General information

Certain functions of some vehicle systems can lead to Active Protection being triggered within their system limits:

- Automatic brake intervention by Forward Collision Mitigation.
- Brake power assistance provided by Forward Collision Mitigation.
- Detection of an impending rear collision by the Rear-collision warning.

Safety information

Warning

The system cannot serve as a substitute for the driver's personal judgment. Due to the system limits, critical situations might not be detected reliably or in time. There is a risk of accident. Adjust driving style to traffic conditions. Watch surrounding traffic closely and actively intervene where appropriate

PreCrash functions

Depending on vehicle equipment and requirements, Active Protection activates the following individual functions in critical driving situations:

- Automatic closing of the windows.
The windows remain open with a small gap.
- Automatic closing of the glass sunroof.
- Automatic positioning of the backrest for the front passenger seat.

Systems can be returned to the desired settings following a critical driving situation without accident.

PostCrash iBrake

Principle

In certain accident situations, PostCrash iBrake can automatically bring the vehicle to a stop without any need for the driver to intervene. This can reduce the risk of a further collision.

After coming to a halt, the brake is released automatically.

The driver can intervene manually to brake the vehicle more sharply or cancel automatic braking with PostCrash iBrake.

Harder vehicle deceleration

In certain situations, it may be necessary to bring the vehicle to a stop more quickly than with PostCrash iBrake automatic braking.

To do this, quickly apply extra force to the brake. The brake pressure will then be higher than the brake pressure generated by automatic braking. Automatic braking with PostCrash iBrake is canceled.

Abort automatic braking

It may be necessary to cancel PostCrash iBrake automatic braking in certain situations, e.g., when making an evasive maneuver.

Automatic braking can be canceled by doing as follows:

- By depressing the brake pedal for slightly longer.
- By pressing the accelerator pedal for slightly longer.

Fatigue alert

Principle

The Fatigue Alert system can detect when the driver is less alert using various criteria.

The Fatigue Alert break recommendation function can detect driver fatigue, e.g., during long, monotonous trips. If necessary, the system will recommend that you take a break. A notice is also displayed on the Interaction Unit.

The break recommendation can be configured on the Interaction Unit.

Safety information

Warning

The system cannot serve as a substitute for the driver's personal judgment in assessing one's physical state. An increasing lack of alertness or fatigue may not be detected or not be detected in time. There is a risk of accident, injury, or property damage. Make sure that the driver is rested and alert. Adjust driving style to traffic conditions.

Break recommendation

Function

After starting a journey, the break recommendation function is trained to the driver, enabling it to detect decreasing alertness or fatigue.

This process takes the following criteria into account:

- Personal driving style, e.g., steering behavior.
- Driving conditions, e.g., the time or duration of the drive.

This function activates at speeds greater than approx. 43 mph/70 km/h and can also display a break recommendation.

Setting break recommendation

The Distraction Warning from the Fatigue Alert system can be turned on or off or configured.

1. Go through the menu as follows:
Apps menu / "Vehicle" / "Driving settings" / "Driver Assistance" / "Safety and warnings" / "Fatigue Alert".
2. Select the desired setting.

Despite this function being off, some driver assistance systems may issue break recommendations.

Display

If the Fatigue Alert system detects that the driver is paying less attention or has become fatigued, a message is displayed on the Interaction Unit recommending that the driver take a break.

During the display, various settings can be selected.

The system is reset approx. 45 minutes after parking the vehicle. A break recommendation can only be displayed again after this time has elapsed.

System limits

The Fatigue Alert system may be limited. If the system is limited, either no warning may be issued or an unwarranted warning may be issued.

The break recommendation function may be limited in the following situations:

- If the time is set incorrectly.
- At a predominantly driven speed below approx. 43 mph/70 km/h.
- With a sporty driving style such as during rapid acceleration or when cornering fast.
- In active driving situations such as when changing lanes frequently.
- When the road condition is poor.
- In the event of strong side winds.

Driving stability control systems

Vehicle features and options

This chapter describes model-specific equipment, systems, and functions that are currently available, or may become available in the future, even if they are not present in the vehicle.

Additional information:

Vehicle equipment, refer to page 8.

Antilock Braking System

Principle

The Antilock Braking System prevents locking of the wheels during the braking process.

The vehicle maintains its steerability even during emergency braking, which increases the active driving safety.

The Antilock Braking System activates automatically whenever drive-ready state is turned on.

Malfunction



The warning light illuminates on the Interaction Unit.



A Check Control message is displayed.

- The Antilock Braking System is not available.
- The ability to steer is restricted during full braking.

Have the vehicle checked immediately by an authorized service center or another qualified service center or repair shop.

Brake assistant

The brake assistant automatically applies maximum braking assistance when the brake pedal is depressed quickly. This reduces the braking distance to a minimum for full braking.

To make full use of braking assistance, do not reduce the pressure on the brake pedal during full braking.

Dynamic Stability Control

Principle

Dynamic Stability Control can be activated or deactivated via MINI Modes. Dynamic Stability Control helps keep your vehicle safely on the road in critical driving situations. The drive power is reduced depending on the situation, and wheels can be braked individually.

The Dynamic Stability Control will detect, e.g., the following unstable driving conditions:

- Skidding, which can lead to oversteering.
- Loss of adhesion of the front wheels, which can lead to understeering.

Safety information

Warning

The system cannot serve as a substitute for the driver's personal judgment in assessing the traffic situation. Based on the limits of the system, it cannot independently react to all traffic situations. There is a risk of accident, injury, or property

damage. Adjust driving style to traffic conditions. Watch the surrounding traffic situation closely, be ready to take over steering and braking at any time, and actively intervene where appropriate.

Warning

When driving with a roof load, e.g., roof bars, the vehicle's center of gravity is higher. This increases the risk of the vehicle tipping in critical driving situations. There is a risk of accident, injury, or property damage. Drive with roof load only with activated Dynamic Stability Control.

Overview



The MINI Modes switch is located on the switch cluster and labeled EXPERIENCE.

Activating/deactivating Dynamic Stability Control

If Dynamic Stability Control is deactivated, driving stability is restricted when accelerating and cornering.

To support driving stability, reactivate Dynamic Stability Control as soon as possible.

To activate/deactivate Dynamic Stability Control, proceed as follows:

1. Select Go Kart Mode using the MINI Modes switch on the switch cluster.
2. Tap the Settings icon on the Interaction Unit.
3. Go through the menu as follows: "Driving dynamics" / "DSC OFF".

Dynamic Stability Control is deactivated.

Dynamic Stability Control reactivates automatically when changing to another drive mode.

Views on the Interaction Unit

If Dynamic Stability Control is deactivated, DSC OFF is shown on the Interaction Unit.

Dynamic Stability Control is deactivated when the indicator light illuminates.

When the warning light flashes, Dynamic Stability Control is regulating the driving and brake power. The vehicle is stabilized. Reduce the vehicle speed and adjust your driving style to the road conditions.

If the warning light illuminates, Dynamic Stability Control has failed or is initializing. Driving stabilization is restricted or has failed.

If the warning light illuminates continuously, have the vehicle checked immediately by an authorized service center or another qualified service center or repair shop.

Setting for increased driving dynamics

Principle

For a more dynamic driving experience, MINI Modes can be used to increase driving dynamics.

Dynamic Stability Control, and thus driving stability, are limited while accelerating and cornering.

Overview

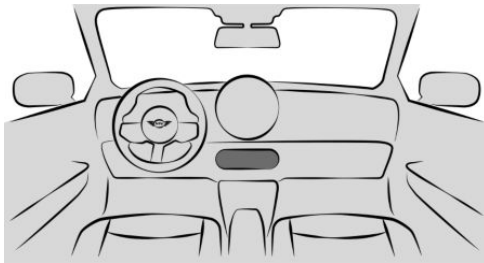



The MINI Modes switch is located on the switch cluster and labeled EXPERIENCE.

Functional requirement

To increase driving dynamics, Go Kart Mode must be selected via MINI Modes:

Activating/deactivating increased driving dynamics

To activate increased driving dynamics, proceed as follows:

1.  Select Go Kart Mode using the MINI Modes switch on the switch cluster.
2.  Tap the Settings icon on the Interaction Unit.
3. Go through the menu as follows: "Driving dynamics" / "SPORT PLUS".

Increased driving dynamics is activated.

Dynamic Stability Control automatically re-activates when changing to another drive mode.

Interaction Unit view



If increased driving dynamics is activated, the Dynamic Stability Control indicator light illuminates on the Interaction Unit.

Automatic program change

Increased driving dynamics deactivates automatically in the following situations, for example:

- When the Distance Control is activated.
- In case of a brake intervention by Forward Collision Mitigation. Deactivate Forward Collision Mitigation as necessary.
- If the suspension control system fails.
- The vehicle has a flat tire.

Additional information:

Forward Collision Mitigation with brake intervention, refer to page [167](#).



Drive-off support

Principle

Drive-off support provides the best possible traction when driving off in certain situations, e.g., on difficult surfaces like snow or sand.

This function ensures maximum drive power at low speeds with adapted driving stability.

Activating/deactivating the drive-off support

To activate drive-off support, go through the menu as follows: Apps menu / "Vehicle" / "Driving settings" / "Drivetrain and chassis" / "Activate drive-off support once".

Drive-off support remains on until it is deactivated or the driving mode is changed.

Display



If drive-off support is activated, the drive-off support indicator light illuminates on the Interaction Unit.

Servotronic

Servotronic is a speed-dependent steering support.

The system provides the steering force with more support at low speeds than at higher ones. This makes it easier to park, for instance, and makes steering firmer when driving at faster speeds.

The steering force adapts to the drive mode to convey a firm, sporty feel or a comfortable steering response.

Driver assistance systems

Vehicle features and options

This chapter describes model-specific equipment, systems, and functions that are currently available, or may become available in the future, even if they are not present in the vehicle.

Additional information:

Vehicle equipment, refer to page 8.

Speed warning

Principle

The speed warning can be used to set a speed limit. A warning will be issued when this speed limit is exceeded.

General information

Another speed warning is given when the set speed limit is exceeded again after it has dropped by 3 mph/5 km/h.

Settings

The Speed Limit Warning can be activated or deactivated. In addition, the speed limit for the warning can be configured.

1. To configure the settings, go through the menu as follows: Apps menu / "Vehicle" / "Driving settings" / "Driver Assistance" / "Safety and warnings" / "Speed warning".
2. Select the desired setting.

Speed Limit Info

Speed Limit Info

Principle

Speed Limit Info uses a camera near the interior rearview mirror to detect road signs at the edge of the road as well as overhead sign posts.

Speed Limit Info shows the current speed limit on the Interaction Unit and, where applicable, Head-up display.

Speed Limit Info may also show speed limits that apply to routes that are not signposted if the navigation system has current map data.

General information

Traffic signs with extra icons are considered and compared with the vehicle's on-board data. Depending on the situation, traffic signs can either be displayed or ignored on the Interaction Unit and, where applicable, Head-up display.

For Speed Limit Info to function correctly, current map data for the country in which the vehicle is operated must be downloaded.

For information on the current map version and map updates, see Map update in the Navigation system chapter.

Without map data, the system is subject to certain technical limitations. Traffic signs with speed limitations are detected and displayed only. Speed limits due to entering towns/cities, highway signs, etc., are not displayed. Speed limits with extra traffic signs are always displayed.

Additional information:

- Owner's Manual for Navigation, Entertainment, and Communication, refer to page 6.

Safety information

Warning





The system cannot serve as a substitute for the driver's personal judgment in assessing the traffic situation. Based on the limits of the system, it cannot independently react to all traffic situations. There is a risk of accident, injury, or property damage. Adjust driving style to traffic conditions. Watch the surrounding traffic situation closely, be ready to take over steering and braking at any time, and actively intervene where appropriate.

Sensors

The system is controlled by a camera behind the windshield.

Display

Speed Limit Info

Icon	Description
	Current speed limit. Depending on the national-market version, it is possible to switch between the units of measurement.
	
	No data on current speed limit available.
	Speed Limit Info not available.

Warning signals

Depending on the settings, an acoustic signal sounds if the detected speed limit is exceeded or the speed limit changes. The display also flashes if the detected speed limit is exceeded.

Settings

Individual settings can be configured for Speed Limit Info, e.g., warnings issued if the speed is exceeded or the permissible maximum speed changes.

1. To configure the settings for Speed Limit Info, go through the menu as follows: Apps menu / "Vehicle" / "Driving settings" / "Driver Assistance" / "Driving" / "Speed Limit Assistant".
2. Select the desired setting.

System limits

System limits of the sensors

Additional information:

- Camera, refer to page 34.

Functional limitations

Speed Limit Info may be restricted and provide incorrect information in the following situations:

- Traffic signs are fully or partially concealed by objects, stickers, or paint.
- Traffic signs do not comply with the standard.
- In areas that are not included in the navigation system map data.
- If navigation system map data is invalid, outdated, or unavailable.
- When roads deviate from the navigation such as due to changes in road layout.
- When driving very close to the vehicle in front of you.



- When passing buses or trucks with traffic signs applied to them.
- In case of electronic traffic signs.
- When traffic signs that are valid for a parallel road are detected.
- In the presence of country-specific road signs or road layouts.

Speed control systems

Principle

The speed control systems provide assistance while driving, for example, by limiting your speed, maintaining your distance, or keeping your vehicle in its lane.

These systems are operated using the buttons on the steering wheel.

Speed control system information is displayed on the Interaction Unit.

General information

Depending on vehicle equipment, the speed control systems include the following individual systems:

- Cruise Control, refer to page 201.
- Distance Control, refer to page 204.
- Assisted Driving Mode, refer to page 210.

Depending on the equipment and national-market version, the individual systems are enhanced with additional functions.

Some functions can be operated via voice control.

Additional information:

MINI Intelligent Personal Assistant, refer to page 49.





Safety information

Warning

The system cannot serve as a substitute for the driver's personal judgment in assessing the traffic situation. Based on the limits of the system, it cannot independently react to all traffic situations. There is a risk of accident, injury, or property damage. Adjust driving style to traffic conditions. Watch the surrounding traffic situation closely, be ready to take over steering and braking at any time, and actively intervene where appropriate.

Overview

Buttons on the steering wheel

Button	Function
	Turn last active speed control system on/off. Interrupt and continue speed control systems.
	Select the desired speed control system.
	Store current speed. Speed Limit Assistant: accept suggested speed manually.
	Set speed.

Turning on/selecting speed control systems

1.  To activate the speed control system, press the on/off button on the left side of the steering wheel. The Interac-





tion Unit contains a toolbar with available speed control systems.

2.  To select a different speed control system while this system is active, repeatedly press the MODE button on the left of the steering wheel until the desired system is displayed on the toolbar on the Interaction Unit.

The system is shown in white when the system can be activated.

The system is shown in green when it can be activated.

The system is grayed out if the system has failed or if the functional requirements are not met.

Icon	Speed control system
	Cruise control.
	Distance control.
	Assisted Driving Mode: Cruise Control with Distance Control, Steering Assistance with lane keeping.

Interrupting speed control systems automatically



Depending on the system, speed control systems are interrupted automatically, for instance in the following situations:

- When changing from selector lever position D to P, N, or R.
- While Dynamic Stability Control regulates driving stability.
- While Dynamic Stability Control is disabled.

- "SPORT PLUS": Upon activating the increased driving dynamics setting.
- When performing a manual braking process.

Interrupting speed control systems manually

Speed control systems can be stopped manually.

-  Press the on/off button on the left side of the steering wheel.
-  Press the MODE button on the left side of the steering wheel.

The speed control system has been stopped.

Continuing speed control systems

-  To resume the speed control system, press the on/off button on the left side of the steering wheel.

The speed control system will resume.

Switching off speed control systems

Speed control systems can be switched off manually.

-  To turn off the speed control system, press and hold the on/off button on the left side of the steering wheel until the indicators go out.

The speed control systems have been switched off.

Speed control systems switch off automatically when drive-ready state is switched off.

Adjusting speed values

The speeds for the speed control systems can be adjusted on the steering wheel.



On the left side of the steering wheel, repeatedly press the rocker button up or down until the desired value is set.

- Each time the rocker button is pressed to the resistance point, the set speed increases or decreases by 1 mph/1 km/h.
- Each time the rocker button is pressed past the resistance point, the set speed changes by a maximum of 5 mph/10 km/h.

Interaction Unit view

Displaying the set speed

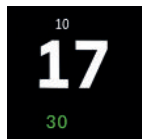

The speed set for the speed control system is shown below the speedometer. The color indicates the system status.

- The speed value illuminates green when a speed control system is activated.
- The speed value illuminates gray when the system is interrupted.
- If no value is displayed, the system turns off.

Notifications

Messages are displayed for some functions on the Interaction Unit in addition to the corresponding speed control system indicator lights.

1. To configure the notification scope, go through the menu as follows: Apps menu / "Vehicle" / "Driving settings" / "Driver Assistance" / "Driving" / "Notifications".
2. Select the desired setting.

Cruise Control

Principle

With the Cruise Control, the buttons on the left of the steering wheel can be used to adjust your set speed. The system maintains the set speed. The system accelerates and brakes automatically as needed.

Cruise control information is shown on the Interaction Unit.

General information

Cruise control can be activated starting from a vehicle speed of 20 mph/30 km/h.

Depending on the vehicle setting, the Cruise Control settings can change under certain conditions. For instance, the acceleration can change depending on the driving mode.

Safety information

Warning

The system cannot serve as a substitute for the driver's personal judgment in assessing the traffic situation. Based on the limits of the system, it cannot independently react to all traffic situations. There is a risk of accident, injury, or property damage. Adjust driving style to traffic conditions. Watch the surrounding traffic situation closely, be ready to take over steering and braking at any time, and actively intervene where appropriate.

Warning

The use of the system can lead to an increased risk of accidents in the following situations, for instance:

- On winding roads.
- With high traffic volume.
- On slippery roads, in fog, snow, or wet conditions, or on a loose road surface.





There is a risk of accident, injury, or property damage. Only use the system if driving at constant speed is possible.

Warning

The set speed can be incorrectly adjusted or called up by mistake. There is a risk of accident, injury, or property damage. Adjust the set speed to the traffic conditions. Watch surrounding traffic closely and actively intervene where appropriate

Overview

Buttons on the steering wheel



Button	Function
	Turn last active speed control system on/off. Interrupt and continue speed control systems.
	Select the desired speed control system.
	Store current speed. Speed Limit Assistant: accept suggested speed manually.
	Set speed.

Turning on the Cruise Control

Cruise Control can be switched on as follows:

For vehicles equipped with Distance Control: Change the Cruise Control mode to Cruise Control without Distance Control.

In vehicles without distance control: turn on the Cruise Control with the buttons on the steering wheel.

-  To switch on Cruise Control, press the on/off button on the left side of the steering wheel.
-  To switch on Cruise Control, press the MODE button on the left side of the steering wheel repeatedly until Cruise Control is selected.

Cruise control is active. The current speed is maintained and stored as desired speed.

The indicator lights on the Interaction Unit illuminate and the mark on the speedometer is set to the current speed.

The driving mode changes or Dynamic Stability Control activates when cruise control is switched on.

Additional information:

Distance Control, refer to page 204.

Turning the speed control system off/interrupting

The speed control system can be turned off or canceled automatically or manually.

Additional information:

Speed control systems, refer to page 199.

Adjusting the speed

Store/maintain speed

The speed can be maintained and stored using the buttons on the steering wheel.

 Press the rocker button on the left side of the steering wheel up or

down once while the system is stopped.

When cruise control is switched on, the current speed is maintained and saved as the desired speed.

The saved speed is shown on the speedometer.

If the Speed Limit Assistant is off, you can also save your current speed with the press of a button.

 Press the SET button on the left side of the steering wheel.

Changing the speed

The speed can be changed with the buttons on the steering wheel.

 On the left side of the steering wheel, repeatedly press the rocker button up or down until the desired speed is set.

If active, the displayed speed is stored and the vehicle reaches the stored speed when the road is clear.

The maximum speed that can be set depends on the vehicle.

Press rocker button to resistance point and hold: The vehicle accelerates or decelerates without the accelerator pedal being pressed.

After the rocker button is released, the vehicle maintains the final speed achieved. Pressing the switch beyond the resistance point causes the vehicle to accelerate more rapidly.

Continuing cruise control

At the stored speed

Warning

The set speed can be incorrectly adjusted or called up by mistake. There is a risk of accident, injury, or property damage. Adjust the set speed to the traffic conditions. Watch surrounding traffic closely and actively intervene where appropriate

An interrupted cruise control can be continued by calling up the stored speed. The difference between the current speed and the stored speed should be as little as possible.

 To resume Cruise Control while the system is stopped, press the on/off button on the left side of the steering wheel.

Cruise control is continued with the stored values.

In the following cases, the stored speed value is deleted and cannot be called up again:

- When the system is switched off.
- When drive-ready state is switched off.

At the current speed

 To continue using the cruise control at the current speed, press the rocker button up or down on the left side of the steering wheel.

Speed Limit Assistant: at the suggested speed

 To apply the speed suggested by the Speed Limit Assistant to the Cruise Control, press the SET button on the left of the steering wheel.

Views on the Interaction Unit

Displaying the set speed

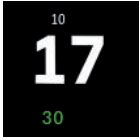

The speed set for the speed control system is shown below the speedometer. The color indicates the system status.

- The speed value illuminates green when a speed control system is activated.
- The speed value illuminates gray when the system is interrupted.
- If no value is displayed, the system turns off.

Indicator light



The cruise control status is also given by the indicator light on the Interaction Unit. The indicator light illuminates green when the system is activated.

Displays in the Head-up display

Depending on vehicle equipment, some speed control system information can also be displayed on the Head-up display.

System limits

Depending on the drive mode or drive power, the vehicle may exceed or drop below the set desired speed in some situations, e.g., when driving uphill or downhill.

Do not use Cruise Control when towing.

Distance control

Principle

With the distance control, a distance to a vehicle driving ahead can be adjusted in addition to the Cruise Control.

The distance can be adjusted at several levels. For safety reasons, it depends on the respective speed.

The system maintains the set speed on clear roads. The vehicle accelerates or brakes automatically.

If a vehicle is driving ahead of you, the system adjusts the speed of the vehicle so that the set distance to the vehicle ahead is maintained. The speed is adjusted as far as the given situation allows.

Distance Control is operated using the buttons on the left of the steering wheel. The distance is set using the Interaction Unit.

Distance Control information is shown on the Interaction Unit.

General information

If the preceding vehicle brakes to a standstill and drives off again shortly afterward, Distance Control is capable of detecting this as far as given conditions allow.

Otherwise, drive off independently such as by stepping on the accelerator pedal or by pressing the button for the speed setting on the steering wheel.

Safety information

Warning

The system cannot serve as a substitute for the driver's personal judgment in assessing the traffic situation. Based on the limits of the system, it cannot independently react to all traffic situations. There is a risk of accident, injury, or property

damage. Adjust driving style to traffic conditions. Watch the surrounding traffic situation closely, be ready to take over steering and braking at any time, and actively intervene where appropriate.

Warning

An unsecured vehicle can begin to move and possibly roll away. There is a risk of accident, injury, or property damage. Before leaving the vehicle, secure the vehicle against rolling away.

In order to ensure that the vehicle is secured against rolling away, follow the following:

- Set the parking brake.
- On uphill grades or on downhill slopes, turn the front wheels in the direction of the curb.
- On uphill grades or on downhill slopes, also secure the vehicle, for instance with a wheel chock.

Warning

The set speed can be incorrectly adjusted or called up by mistake. There is a risk of accident, injury, or property damage. Adjust the set speed to the traffic conditions. Watch surrounding traffic closely and actively intervene where appropriate

Warning







Risk of accident is greater when there is a high speed differential to other vehicles, for instance in the following situations:

- When approaching a slowly moving vehicle at speed.
- Vehicle suddenly swerving into own lane.
- When approaching stationary vehicles at speed.

There is a risk of injury or danger to life. Watch surrounding traffic closely and actively intervene where appropriate

Overview

Buttons on the steering wheel

Button	Function
	Turn last active speed control system on/off.
	Interrupt and continue speed control systems.
	Select the desired speed control system.
	Store current speed.
	Speed Limit Assistant: accept suggested speed manually.
	Set speed.

Sensors

Distance Control is controlled by the following sensors:

- Camera behind the windshield.
- Front radar sensor.

Additional information:

Sensors of the vehicle, refer to page 34.

Application range

Distance Control is best when used on well-maintained roads.





The maximum speed that can be set is limited and depends, for example, on the vehicle and the vehicle equipment.

The system can also be activated when stationary.

Do not use Cruise Control and Distance Control when towing.

Turning on Cruise Control with Distance Control

Switch on Cruise Control with Distance Control using the buttons on the steering wheel.

-  To switch on Cruise Control with Distance Control, press the on/off button on the left side of the steering wheel.
-  If necessary, press the MODE button on the left side of the steering wheel repeatedly until Distance Control is selected.

Cruise Control with Distance Control is active. The current speed is maintained and stored as desired speed.

The selected distance to a vehicle driving ahead is maintained.

The indicator lights on the Interaction Unit illuminate and the mark on the speedometer is set to the current speed.

The driving mode changes or Dynamic Stability Control activates when Distance Control is switched on.

Adjusting the speed

The speed can be set with the buttons on the steering wheel.

Additional information:

Cruise control, refer to page [201](#).

Interrupting Cruise Control with Distance Control automatically

Cruise Control with Distance Control is interrupted automatically in the following situations, for example:

- When performing a manual braking process.
- When selector lever position D is disengaged.
- While Dynamic Stability Control is disabled.
- "SPORT PLUS": When the setting for enhanced driving dynamics is enabled.
- While Dynamic Stability Control regulates driving stability.
- When the driver's seat belt and driver's door are opened.
- If the system has not detected objects for an extended period, for instance on a road with very little traffic without curb or shoulder markings.
- If the detection range of the radar is impaired, for instance by contamination or heavy precipitation.
- After a longer stationary period when the vehicle has been braked to a stop by the system.

Turning the speed control system off/interrupting

The speed control system can be turned off or canceled automatically or manually.

Additional information:

Speed control systems, refer to page [199](#).



Continuing cruise control while driving

Warning

The set speed can be incorrectly adjusted or called up by mistake. There is a risk of accident, injury, or property damage. Adjust the set speed to the traffic conditions. Watch surrounding traffic closely and actively intervene where appropriate

An interrupted cruise control can be continued by calling up the stored speed. The difference between the current speed and the stored speed should be as little as possible.

Additional information:

Cruise control, refer to page 201.

Continuing cruise control while vehicle is stationary

If the cruise control is stopped, the driver may need to confirm their intention to drive off in certain situations.

The displays show the following:

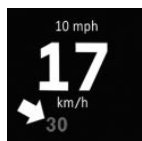

The speed set for the speed control system is shown in gray below the speedometer.



The indicator light illuminates green.

Cruise control can be continued as follows:

- Pressing the accelerator pedal.



- Press the rocker button on the left side of the steering wheel.



- Press the button on the left side of the steering wheel.

Distance

Safety information

Warning

The system cannot serve as a substitute for the driver's personal judgment. Due to the system limits, deceleration can be late. There may be a risk of accidents or risk of damage to property. Be aware of the surrounding traffic situation at all times. Adjust the distance to the traffic and weather conditions and maintain the prescribed safety distance, possibly by braking.

Adjusting the distance

1. To adjust the distance, go through the menu as follows: Apps menu / "Vehicle" / "Driving settings" / "Driver Assistance" / "Driving" / "Distance control" / "Distance".
2. Select the desired setting.

Automatic adaptation of the distance

Depending on vehicle equipment and national-market version, Distance Control can be configured to automatically adjust the distance to the preceding vehicle within the set distance. The system analyzes the traffic situation and ambient conditions, e.g., poor visibility.

To have the distance adjusted automatically, go through the menu as follows: Apps menu / "Vehicle" / "Driving settings" / "Driver Assistance" / "Driving" / "Distance control" / "Situational distance control".

Changing between Cruise Control with/without Distance Control

Safety information

Warning

The system does not react to traffic driving ahead of you, but instead maintains the stored speed. There is a risk of accident, injury, or property damage. Adjust the set speed to the traffic conditions and brake as needed.

Changing over the Cruise Control mode

To switch between cruise control with/without Distance Control, go through the menu as follows: Apps menu / "Vehicle" / "Driving settings" / "Driver Assistance" / "Driving" / "Distance control" / "Switch to Cruise Control".

The setting is reset when the vehicle is parked.

Views on the Interaction Unit



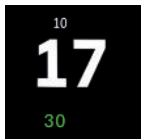

Displaying the set speed



The speed set for the speed control system is shown below the speedometer. The color indicates the system status.

- The speed value illuminates green when a speed control system is activated.
- The speed value illuminates gray when the system is interrupted.
- If no value is displayed, the system turns off.

Indicator lights and warning lights

Icon	Description
	Indicator light illuminates white: No Distance Control because accelerator pedal is being pressed.
	Indicator light illuminates green: Vehicle has been detected ahead of you. The vehicle icon goes out if no vehicle has been detected ahead of you. Indicator light flashes green: Preceding vehicle has driven off.
	Indicator light flashes gray: Conditions are not adequate for the system to work. The system was deactivated but applies the brakes until you actively resume control by pressing on the brake pedal or accelerator pedal.
	Warning light flashes red and acoustic signal sounds: Brake and make an evasive maneuver, if necessary.

Assisted View

Depending on vehicle equipment and national-market version, in Assisted View, Distance Control information is shown in the central display area on the Interaction Unit.

Additional information:

Assisted View, refer to page [145](#).



Displays in the Head-up display

Set speed

Depending on vehicle equipment, some speed control system information can also be displayed on the Head-up display.

Distance information



The distance information icon appears when the distance from the preceding vehicle is too short.

The distance information is active in the following situations:

- Cruise Control with Distance Control is switched off.
- The view on the Head-up display is selected.
- Distance to preceding vehicle is too short.
- Vehicle speed is greater than approx. 40 mph/70 km/h.

Additional information:

Head-up display, refer to page [132](#).

System limits

System limits of the sensors

Distance Control is subject to the system limits of the sensors.

Additional information:

- Cameras, refer to page [34](#).
- Radar sensors, refer to page [35](#).

Detection range

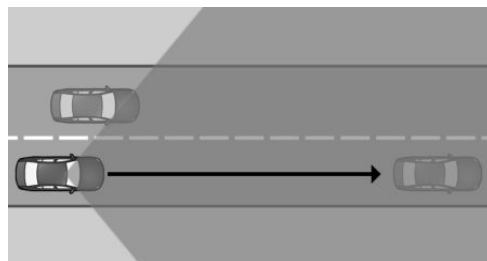

The vehicle sensors detect the traffic situation in their detection range.

The sensor detection capability and automatic braking power are limited.

For instance, two-wheeled vehicles may not be detected.

Deceleration

Distance Control does not decelerate in the following situations:

- For pedestrians or similarly slow-moving road users.
- For cross traffic.
- For oncoming traffic.

Merging vehicles

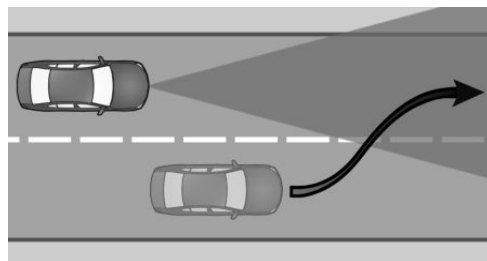

Distance Control may not be able automatically restore your chosen distance if a preceding vehicle suddenly cuts into your lane. It may not be possible to restore the selected distance in certain situations, including if you are driving significantly faster than vehicles driving ahead of you, for in-

stance when rapidly approaching a truck. When a vehicle has been detected ahead of you, the system requests that the driver intervene by braking and making an evasive maneuver, if needed.

Cornering

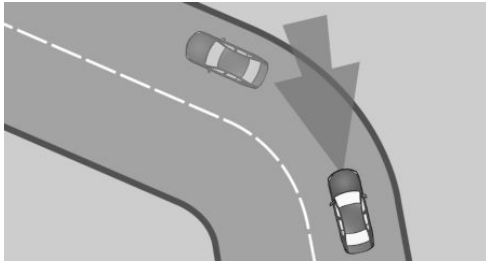

When Distance Control is on, if your set speed is too high for a bend, your vehicle will be slowed slightly in the bend. Because curves may not be anticipated in advance, drive into a curve at an appropriate speed.

Distance Control has a limited detection range. Situations can arise in tight curves where a vehicle driving ahead will not be detected or will be detected very late.

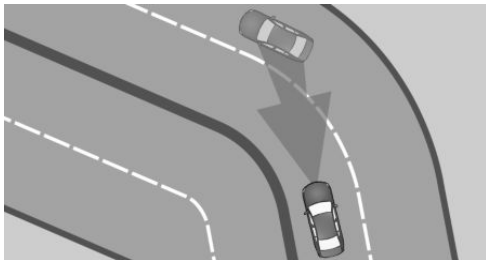

When you approach a curve the system may briefly report vehicles in the next lane due to the bend of the curve. If the system decelerates you may compensate for it by briefly accelerating. After releasing the accelerator pedal the system is reactivated and controls speed independently.

Driving off

Your vehicle cannot drive off automatically using Distance Control in the following situations, for example:

- On steep uphill grades.
- In front of bumps in the road.

In these cases, step on the accelerator pedal.

Weather

Under unfavorable weather or light conditions, Distance Control may be limited in the following ways:

- Poorer vehicle detection.
- Short-term interruptions for vehicles that are already recognized.

Drive attentively, and react to the current surrounding traffic situation. If necessary, intervene actively, for instance by braking, steering or making an evasive maneuver.

Drive power

Depending on the drive mode or drive power, the vehicle may exceed or drop below the set desired speed in some situations, e.g., when driving uphill or downhill.

Assisted Driving Mode

Principle

Assisted Driving Mode enhances Distance Control with Steering Assistance and lane keeping. The system assists the driver in keeping the vehicle within the lane. For this purpose, the system executes supporting steering movements, for instance when cornering.

Assisted Driving Mode is operated using the buttons on the steering wheel.



Depending on vehicle speed, Assisted Driving Mode orients itself using the lane markings or preceding vehicles.

Sensors in the steering wheel detect whether the steering wheel is being touched.

System information is given in the Interaction Unit views and indicated the steering wheel LEDs.

If a lane boundary is crossed, the system issues a warning by vibrating the steering wheel. The steering wheel vibration intensity can be adjusted.

Safety information

Warning

The system cannot serve as a substitute for the driver's personal judgment in assessing the traffic situation. Based on the limits of the system, it cannot independently react to all traffic situations. There is a risk of accident, injury, or property damage. Adjust driving style to traffic conditions. Watch the surrounding traffic situation closely, be ready to take over steering and braking at any time, and actively intervene where appropriate.





The Cruise Control and Distance Control alerts also apply.

Additional information:

- Cruise control, refer to page 201.
- Distance Control, refer to page 204.

Overview

Buttons on the steering wheel

Button	Function
	Turn last active speed control system on/off. Interrupt and continue speed control systems.
	Select the desired speed control system.
	Store current speed. Speed Limit Assistant: accept suggested speed manually.
	Set speed.

Sensors

Assisted Driving Mode is controlled by the following sensors:

- Camera behind the windshield.
- Front radar sensor.
- Depending on vehicle equipment, via the rear, side radar sensors.
- The sensors in the steering wheel.

Additional information:

- Sensors of the vehicle, refer to page 34.



Functional requirements

The following functional requirements apply for Assisted Driving Mode:

- Vehicle speed must remain below 110 mph/180 km/h.
- The lane is sufficiently wide.
- Hands are on the steering wheel rim.
- The bend radius is sufficiently large.
- The vehicle is driving in the center of the lane.

- The sensor system calibration process is complete.
- Distance Control is active.
- The seat belt on the driver's side is fastened.
- Forward Collision Mitigation is active.

Switching on Assisted Driving Mode

1.  To switch Assisted Driving Mode on, press the on/off button on the left side of the steering wheel.
2.  If necessary, press the MODE button on the left side of the steering wheel until Assisted Driving Mode is selected on the Interaction Unit toolbar.

System activates automatically as soon as all function conditions are fulfilled.

The status of Assisted Driving Mode is displayed on the Interaction Unit.

 The indicator light illuminates gray when the system is ready and not performing any steering movement.

 The indicator light illuminates green when the system is activated.

When this system is on, Forward Collision Mitigation activates.

Stopping Assisted Driving Mode automatically

Assisted Driving Mode automatically interrupts steering support in the following situations, for example:





- At a vehicle speed above 110 mph/180 km/h.
- After releasing the steering wheel.
- With a strong steering intervention.

- When leaving own lane.
- Turn signal is on.
- Lane is too narrow.
- If a lane boundary is not detected and there is no vehicle driving in front.
- The Cruise Control with Distance Control is interrupted.
- The seat belt on the driver's side is unfastened.



 The indicator light illuminates gray when the system is ready and not performing any steering movement.

System activates automatically as soon as all function conditions are fulfilled.

Views on the Interaction Unit

Icon	Description
	Indicator light illuminates gray: The system is ready.
	Indicator light illuminates green: The system is activated. The system supports the driver in keeping the vehicle within the lane.
	Warning light flashes yellow and steering wheel vibrates: A lane boundary has been crossed.
	Warning light illuminates yellow and acoustic signal sounds: System interruption is imminent.
	Warning light flashes red and acoustic signal sounds: The system is switched off or will be interrupted very soon.



Icon	Description
	<p>Warning light illuminates yellow: Hands are not grasping the steering wheel. The system is still active.</p> <p>Grab the steering wheel with your hands.</p>
	<p>Warning light illuminates red, acoustic signal sounds: Hands are not grasping the steering wheel. System interruption is imminent.</p> <p>The system reduces the speed to a standstill if applicable.</p> <p>It is possible that the system will not execute any supporting steering movements.</p> <p>Grab the steering wheel immediately with your hands.</p>

Depending on vehicle equipment and national-market version, in Assisted View, Assisted Driving Mode information is shown in the central display area on the Interaction Unit.

Additional information:

Assisted View, refer to page 145.

Displays on the steering wheel



Similar to the displays for Assisted Driving Mode on the Interaction Unit, the two LEDs

above the keypads on the steering wheel illuminate.

1. To turn the steering wheel displays on/off, go through the menu as follows: Apps menu / "Vehicle" / "Driving settings" / "Driver Assistance" / "Feedback via steering wheel" / "Light elements".
2. Select the desired setting.

Displays in the Head-up display

Depending on vehicle equipment, Assisted Driving Mode information can also be shown on the Head-up display.

Setting the intensity of the steering wheel vibration

1. To adjust the steering wheel vibration intensity, go through the menu as follows: Apps menu / "Vehicle" / "Driving settings" / "Driver Assistance" / "Feedback via steering wheel" / "Vibration intensity".
2. Select the desired setting.

This setting is applied to all collision warning systems.

System limits

General information

Assisted Driving Mode cannot be activated or used sensibly in certain situations.

Safety information

Warning

Because of system limitations, this system may either not respond, or respond too late, incorrectly, or without cause. There is a risk of accident, injury, or property damage. Actively intervene as warranted. Refer to the information in this Owner's



Manual regarding the scope of the system's operation and limitations.

The Cruise Control and Distance Control alerts also apply.

Additional information:

- Cruise control, refer to page 201.
- Distance Control, refer to page 204.

System limits of the sensors

Assisted Driving Mode is subject to the system limits of the sensors.

Additional information:

- Cameras, refer to page 34.
- Radar sensors, refer to page 35.

Hands on the steering wheel

The sensors cannot detect hand-steering wheel contact in the following situations:

- Driving with gloves.
- Protective covers on the steering wheel.

Weather

With unfavorable weather or light conditions, Assisted Driving Mode may be limited as follows:

- Poorer recognition of vehicles and lane boundaries.
- Short-term interruptions in case of already detected vehicles and lane boundaries.

Drive attentively, and react to the current surrounding traffic situation. If necessary, intervene actively, for instance by braking, steering or making an evasive maneuver.

Speed Limit Assistant

Principle

Speed Limit Assistant supports driving at the speed limit. You can have speeds suggested by the Speed Limit Assistant adopted by your vehicle's speed control systems.

The Speed Limit Assistant is turned on/off using the Interaction Unit and operated using the buttons on the steering wheel.

Suggested speeds can be adjusted by entering tolerances.

System information is shown on the Interaction Unit.

General information

When the systems in the vehicle, e.g., Speed Limit Info, detect a change of the speed limit, this new speed value can be applied for the following systems:

- Cruise control.
- Distance Control.
- Assisted Driving Mode.

The speed value is suggested as the new desired speed to be applied. To apply the speed value, the corresponding system must be activated.

Safety information

Warning

The system cannot serve as a substitute for the driver's personal judgment in assessing the traffic situation. Based on the limits of the system, it cannot independently react to all traffic situations. There is a risk of accident, injury, or property damage. Adjust driving style to traffic conditions. Watch the surrounding traffic situation closely, be ready to take over steer-



ing and braking at any time, and actively intervene where appropriate.

Warning

The set speed can be incorrectly adjusted or called up by mistake. There is a risk of accident, injury, or property damage. Adjust the set speed to the traffic conditions. Watch surrounding traffic closely and actively intervene where appropriate

Overview

Buttons on the steering wheel

Button	Function
	Accept suggested speed manually.
	Set speed, refer to Cruise Control.

Turning Speed Limit Assistant on/off

- To configure the settings for Speed Limit Assist, go through the menu as follows: Apps menu / "Vehicle" / "Driving settings" / "Driver Assistance" / "Driving" / "Speed Limit Assistant".
- Select the desired setting:
 - "Adjust manually": detected speed limits can be applied manually.
 - "Show current limit": Current speed limits are displayed on the Interaction Unit without being applied.
 - "Off": depending on the national-market version, Speed Limit Info and Speed Limit Assistant will be turned off.



If necessary, other anticipatory comfort functions will be turned off.

Additional information:

Speed Limit Info, refer to page 197.

Views on the Interaction Unit

A message is displayed on the Interaction Unit when the Speed Limit Assistant and a speed control system activate.

Icon	Function
	Detected change of a speed limit with immediate effect. Depending on the national-market version, it is possible to switch between the units of measurement.
	
	Indicator light illuminates green: The detected speed limit can be applied with the SET button. After it has been applied, a green checkmark is displayed.

Manual adoption

A detected speed limit can be applied manually to the active speed control system.

 When the SET icon is displayed, press the SET button on the left side of the steering wheel.

Speed adjustment

General information

Speed Limit Assist can be configured to adopt the speed limit 1:1 or with a tolerance.

A speed adaptation for all speed limits and an additional speed adaptation for speed limits up to 40 mph/60 km/h can be set up.



The additional speed adaptation for speed limits up to 40 mph/60 km/h can be activated or deactivated.

Setting the speed adjustment

1. To adjust the speed for Speed Limit Assist, go through the menu as follows: Apps menu / "Vehicle" / "Driving settings" / "Driver Assistance" / "Driving" / "Speed Limit Assistant".
2. Select the desired setting:
 - "Adjust speed limits": Set a tolerance for a speed adjustment. This tolerance applies to all speed limits.
 - "2nd adjustment up to ": Activate or deactivate additional speed adjustment.
 - "Adjust speed limits": First activate additional speed adjustment, then set a tolerance for speed limits up to 40 mph/60 km/h.

System limits

Speed Limit Assistant is based on the Speed Limit Info system.

Note the system limits for Speed Limit Info.

Additional information:

- System limits of Speed Limit Info, refer to page 198.
- System limits of the sensors, refer to page 34.

Adapting the speed to the route

Principle

The cruise control can be configured to automatically adjust the vehicle speed to the route when Distance Control is active.

For instance, the speed will be reduced in the following situations as necessary:

- Before making turns.
- Before a roundabout.
- Before a curve.
- In front of an exit ramp on highways or highway-like roads.

This function is operated via the Interaction Unit.

Safety information

Warning

The system cannot serve as a substitute for the driver's personal judgment in assessing the traffic situation. Based on the limits of the system, it cannot independently react to all traffic situations. There is a risk of accident, injury, or property damage. Adjust driving style to traffic conditions. Watch the surrounding traffic situation closely, be ready to take over steering and braking at any time, and actively intervene where appropriate.

The Cruise Control, Distance Control, Assisted Driving Mode, and Speed Limit Assist alerts also apply.

Additional information:

- Cruise control, refer to page 201.
- Distance Control, refer to page 204.
- Assisted Driving Mode, refer to page 210.
- Speed Limit Assistant, refer to page 214.

Functional requirements

The following functional requirements apply when adapting vehicle speed to the route:



- Cruise Control and Distance Control are activated.
- Driving on a highway or highway-like road.
- Guidance is activated in the navigation system.

The use of navigation software via Apple CarPlay or Android Auto may lead to functional limitations, for instance deviations with navigation instructions.

- The function must be available in the country in which the vehicle is driven.

Adapting speed automatically to route

To activate/deactivate automatic speed adjustment, go through the menu as follows: Apps menu / "Vehicle" / "Driving settings" / "Driver Assistance" / "Driving" / "Route speed control" / "Adjust speed automatically".

Adjusting the cornering speed

The cornering speed can be adjusted depending on national-market version.

1. Go through the menu as follows: Apps menu / "Vehicle" / "Driving settings" / "Driver Assistance" / "Driving" / "Route speed control" / "Cornering speed".
2. Select the desired setting.

Views on the Interaction Unit

Depending on vehicle equipment and national-market version, in Assisted View, Route-Ahead Assistant information is shown in the central display area on the Interaction Unit.

Additional information:

Assisted View, refer to page [145](#).

System limits

Depending on national-market version or the country in which the vehicle is currently being driven, the Route-Ahead Assistant may not be available.

The system does not react or reacts to a limited extent to the route ahead in the following situations:

- If the vehicle location cannot be clearly determined by the navigation system.
- On wintry roads.

Additionally, the limits for Cruise Control, Distance Control, Assisted Driving, and Speed Limit Assist systems apply.

Additional information:

- Cruise control, refer to page [201](#).
- Distance Control, refer to page [204](#).
- Assisted Driving Mode, refer to page [210](#).
- Speed Limit Assistant, refer to page [214](#).

Parking

Vehicle features and options

This chapter describes model-specific equipment, systems, and functions that are currently available, or may become available in the future, even if they are not present in the vehicle.

Additional information:

Vehicle equipment, refer to page 8.

Parking assistance systems

Principle

With the Park Distance Control display and various camera views, the parking assistance systems help to park, maneuver, and reverse the vehicle. Parking assistance systems are operated using the Park Assist key or via the Parking menu.

When parking or reversing, the following individual systems provide active support with assistance functions and sensors:

- Park Distance Control, refer to page 230.
- Active Park Distance Control, refer to page 233.
- Drive-off monitoring, refer to page 234.
- Park Assist, refer to page 235.
- Reversing Assistant, refer to page 240.

Various camera views and camera perspectives provide excellent visibility of the vehicle surroundings while parking and maneuvering. Depending on vehicle equipment, different camera views are available.

The following camera views can be used with the basic version:

- Rearview camera, refer to page 223.
- Panorama view, rear, refer to page 227.

Depending on vehicle equipment, additional camera views can be used with parking view:

- Semi-automatic camera perspective, refer to page 224.
- Automatic camera perspective, refer to page 224.
- Side view, refer to page 225.
- 3D view, refer to page 226.
- Car wash view, refer to page 226.
- Panorama view, front, refer to page 227.
- Activating panorama view using activation points, refer to page 227.
- Door opening angle, refer to page 228.
- Remote 3D View, refer to page 229.

The individual camera-based systems are operated by selecting camera views on the Interaction Unit. The camera views can be turned on and off by selecting the corresponding icon. Additional views with parking assistance lines or obstacle markings can be shown.

Safety information

Warning

The system cannot serve as a substitute for the driver's personal judgment in assessing the traffic situation. Based on the limits of the system, it cannot independently react to all traffic situations. There is a risk of accident, injury, or property damage. Adjust driving style to traffic conditions. Watch the surrounding traffic situation closely, be ready to take over steering and braking at any time, and actively intervene where appropriate.

Overview

Button in the vehicle

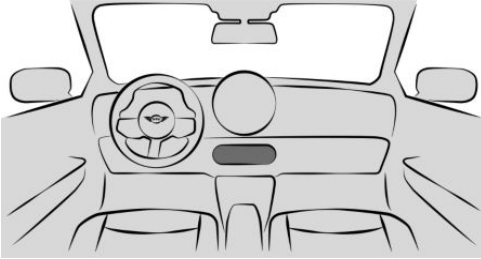

The Park Assist key is located on the switch cluster.

Sensors

The parking assistance systems are controlled by the following sensors:

- Ultrasonic sensors in the front/rear bumpers.
- Ultrasonic sensors at the sides.
- Front camera.
- Exterior mirror cameras.
- Rearview camera.

Additional information:

Sensors of the vehicle, refer to page [34](#).

Calling up Park menu

Some parking assistance systems can be set individually in the Park menu.

1. To bring up the Parking menu, go through the menu as follows: Apps menu / "Vehicle" / "Driving settings" / "Driver Assistance" / "Parking".
2. Select the desired settings.

Display

Turning display on/off

General information

The parking assistance systems view switches off automatically when driving forwards or if a certain distance or speed is exceeded.

With reverse gear

When drive-ready state is on, the parking assistance systems display is automatically turned on when you engage selector lever position R.

With the Park Assist key



To turn on the parking assistance system display, press the Park Assist key on the switch cluster.

On the Interaction Unit

To turn on the parking assistance systems display, go through the menu as follows: Apps menu / "Vehicle" / "Parking".

Interaction Unit view

General information

The parking assistance system view on the Interaction Unit varies depending on vehicle equipment and the active parking assistance system.

Assistance view

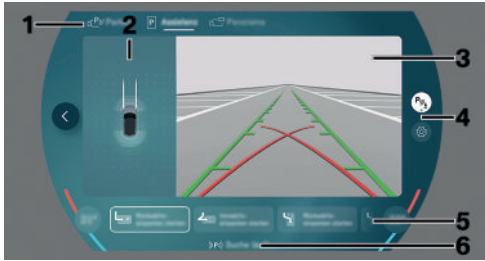

- 1 Selecting a camera view
- 2 Vehicle top view
- 3 Camera image
- 4 Settings
- 5 Toolbar, bottom
- 6 Status of parking assistance systems

Parking view

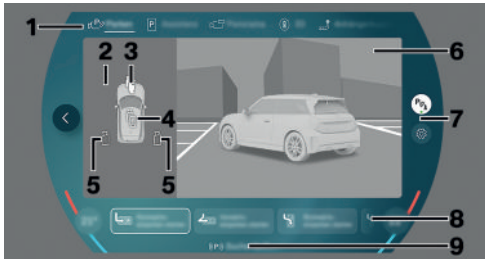

- 1 Selecting a camera view
- 2 Selection window
- 3 Automatic camera perspective
- 4 Semi-automatic camera perspective
- 5 Side view
- 6 Camera image
- 7 Settings
- 8 Toolbar, bottom
- 9 Status of parking assistance systems

Camera image

Depending on the equipment, one or more cameras capture the area from different selectable perspectives.

Depending on the view, the vehicle's surroundings or a part of it is depicted.

Depending on the national-market version, either the automatic or the semi-automatic camera perspective is displayed.

Selecting a camera view

Depending on vehicle equipment, various camera views can be selected at the top of the Interaction Unit:

- "Parking"
Depending on vehicle equipment, camera views or the Park Distance Control view are displayed.
- "Assistance"
A stylized top view of the vehicle is displayed.
- "Panorama"
The cross traffic view is displayed.
- "3D"
A three-dimensional view of the vehicle is displayed.
- "Car wash"
Your own lane can be displayed to make it easier to drive into a car wash.

Settings

Various settings are provided on the right side of the Interaction Unit:

- Depending on national-market version, the acoustic warning for Park Distance Control can be turned on/off.
- Settings can be configured in the Parking menu.

Toolbar, bottom

Parking Assistant functions are displayed on the bottom toolbar:



- Available parking methods of the Automatic Parking Assistant.
- Functions of the Back-up Assistant.
- Additional information in case of malfunctions.

Status of parking assistance systems

The status of the parking assistance systems is indicated by the icons at the bottom of the Interaction Unit, near the driving information, and on the Head-up display, depending on vehicle equipment. In addition to this icon, supplementary text appears at the bottom of the Interaction Unit.

The following parking assistance systems are displayed:

- Automatic Parking Assistant.
- Back-up Assistant.

Icon	Meaning
	No search for parking assistance system offers. No other parking assistance systems available. Parking assistance systems have failed.
	Searching for parking assistance system offers is active.
	White: an available maneuver is selected but is not being performed. Functional requirements have not been met or the function transfer is complete. Green: A parking assistance system is on. Functions are controlled depending on the system activated.

Additional displays

General information

Additional views can be shown in the camera image for the parking assistance systems display, e.g., parking aid lines. This makes parking and maneuvering easier.

Several additional displays can be active at the same time.

Turning additional displays on/off

1. To turn additional displays in the camera view on/off, go through the menu as follows: Apps menu / "Vehicle" / "Driving settings" / "Driver Assistance" / "Parking".
2. Select the desired setting.

Parking aid lines

Pathway lines

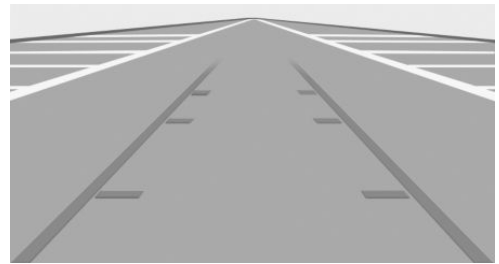

The pathway lines help to estimate the required space when parking and maneuvering on level roads.

Depending on engaged gear position, the Interaction Unit camera view provides pathway lines in front of or behind the vehicle.

The pathway lines are continuously adjusted to the steering movements depending on the steering-wheel angle.



Turning circle lines

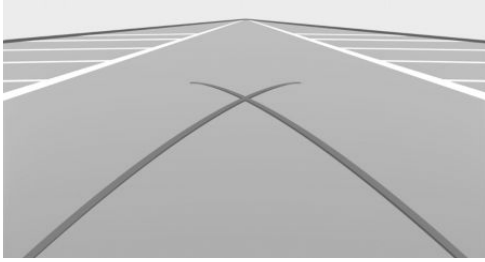

The Interaction Unit camera view includes turning circle lines that show the path with the smallest possible turning circle on a level road.

Only one turning circle line is displayed after the steering wheel is turned past a certain angle.

Turning circle lines can only be superimposed on the camera image together with pathway lines.

Using parking aid lines

1. Position the vehicle so that the red turning circle line leads into the boundaries of the parking space.
2. Turn the steering wheel so that the green pathway line covers the corresponding turning circle line.

Obstacle marking

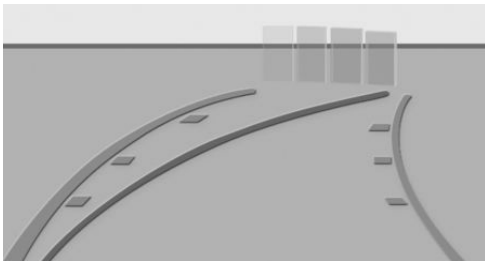

The sensors detect obstacles when parking.

Obstacles detected by Park Distance Control are shown and marked in the camera view on the Interaction Unit.

Colored gradients for the obstacle markings in green, yellow and red indicate the distances.

Functional limitations

The parking assistance systems can only be used to a limited extent in the following situations:

- With a door open.
- With open cargo area.
- With exterior mirrors folded in.

Areas with gray hatching with an icon in the camera image identify areas that are currently not shown such as an open door.

System limits

Safety information

Warning

Because of system limitations, this system may either not respond, or respond too late, incorrectly, or without cause. There is a risk of accident, injury, or property damage. Actively intervene as warranted. Refer to the information in this Owner's Manual regarding the scope of the system's operation and limitations.

System limits of the sensors

Parking assistance systems may be restricted by the system limits of the sensors.

Additional information:

Sensors of the vehicle, refer to page 34.

Field of view

Because of the camera angle, the areas under the vehicle cannot be viewed by the cameras.

Detection of objects

The sensors may not detect very low obstacles as well as high, protruding objects, e.g., wall ledges.

Objects shown on the Interaction Unit may be closer than they appear. Do not estimate the distance to objects shown on the Interaction Unit.

The camera's detection range can be limited by protruding cargo or a rear carrier.

Malfunction

A camera failure is indicated on the Interaction Unit.

The malfunctioning camera's detection range is shaded.

Rearview camera

Principle

The rearview camera helps when reverse parking and maneuvering. The area behind the vehicle is shown in the camera view on the Interaction Unit. The rearview camera turns on when reversing and can be operated via the Interaction Unit or Park Assist key.

Additional displays can be shown on the camera view, e.g., parking assistance lines and obstacle markings.

General information

Follow the information in the "Parking assistance systems" chapter.

Functional requirements

The following functional requirements apply for the rearview camera:

- The trunk is fully closed.
- The camera area is clean and clear.

Turning the rearview camera on/off



Turning the camera view on automatically

The rearview camera is automatically turned on if selector lever position R is engaged while drive-ready state is on.

Turning the camera view off automatically

The rearview camera turns off automatically when driving forward or when a certain distance or speed is exceeded.

Turning the camera view on/off manually

1.  To manually turn on the rearview camera, press the Park Assist key on the switch cluster.
The parking assistance systems view is displayed.
2. Engage selector lever position R.
The rearview camera view is switched on.
 Depending on vehicle equipment: The icon for automatic camera perspective is automatically selected in the selection window.

To exit rearview camera view, select another camera view in the selection window or press the Park Assist key again.



Deactivated rearview camera

When the rearview camera is deactivated, for instance when the trunk is open, the camera image is displayed with gray shading.

Semi-automatic camera perspective

Principle



Depending on the parking direction and engaged selector lever position, the semi-automatic camera perspective shows a fixed camera perspective with the areas in front of or behind the vehicle.

The camera perspective can be turned on/off using the Interaction Unit.

General information

Follow the information in the "Parking assistance systems" chapter.

Turning the semi-automatic camera perspective on/off

-  To turn on semi-automatic camera perspective, press the Park Assist key on the switch cluster.
The parking assistance systems view is displayed.
-  Select the semi-automatic camera perspective icon in the selection window.

To exit the fixed camera view, select another camera view in the selection window.

Automatic camera perspective

Principle

The automatic camera perspective shows a steering-dependent view in the respective driving direction. This perspective adapts to the respective driving situation.

As soon as obstacles are detected, the view changes to a fixed display of the area in front of or behind the bumper, or switches to side Park Distance Control as necessary.

The side Park Distance Control is automatically displayed when the automatic camera perspective is turned on. The function shows obstacles located next to the vehicle.

The camera perspective can be turned on/off using the Interaction Unit.

General information

Follow the information in the "Parking assistance systems" chapter.

Turning the automatic camera perspective on/off

Turning the camera view on/off automatically

When the parking assistance systems' display is turned on, automatic camera perspective is selected automatically.



 The icon for automatic camera perspective is automatically selected in the selection window.

To exit the steering-dependent camera view, select another camera view in the selection window.

When reverse gear is engaged, the automatic camera perspective is, if necessary, exited and the system uses a semi-automatic camera perspective to the rear. If necessary, select the automatic camera perspective when reverse gear is engaged. The

automatic camera perspective will then be maintained for the current parking operation.

Turning the camera view on/off manually

-  To turn on automatic camera perspective manually, press the Park Assist key on the switch cluster.
The parking assistance systems view is displayed.
-  The icon for automatic camera perspective is automatically selected in the selection window.

To exit the steering-dependent camera view, select another camera view in the selection window or press the Park Assist key again.

Lateral Parking Aid display



To protect the sides of the vehicle, obstacle markings are displayed on the sides of the vehicle.

Colored obstacle markings warn the driver when obstacles have been detected.

If no obstacle markings are displayed, no obstacles have been detected.

Limits of the side protection

The Lateral Parking Aid only displays stationary obstacles that were previously detected by the sensors while passing them.

The system does not detect whether an obstacle moves later on. For this reason, at standstill, the marks are not shown anymore in the display after a certain time. The area next to the vehicle must be newly captured.

Side view

Principle

Side view shows the vehicle's side surroundings, making it easier to position the vehicle at the curb or with other obstacles on the side.

The camera view looks from the rear to the front and, if there is a hazard, focuses automatically on potential obstacles.



The side view can be turned on/off using the Interaction Unit.

General information

Follow the information in the "Parking assistance systems" chapter.

Turning the side view on/off

The selection window lets you choose the side view for the left or right side of the vehicle.

-  To turn on side view, press the Park Assist key on the switch cluster.
The parking assistance systems view is displayed.
-  Select the camera icon for the desired vehicle side in the selection window.

To exit the side view, select another camera view in the selection window.



3D view

Principle

With 3D view, a circle is displayed around the vehicle top view in the selection window.

Fixed perspectives can be selected directly on the circular path in the selection window, or by swiping the vehicle in the middle of the camera image.

The current perspective is marked with a camera icon on the circular path.

3D view can be turned on/off using the Interaction Unit.

General information

Follow the information in the "Parking assistance systems" chapter.

Turning the 3D view on/off

-  To turn on 3D view, press the Park Assist key on the switch cluster.
The parking assistance systems view is displayed.
- In the upper selection area, select the following camera view: "3D".

To exit 3D view, select another camera view from the selection at the top.

Car wash view

Principle

The car wash view assists when entering a car wash.

This function can be turned on/off using the Interaction Unit.

General information

Follow the information in the "Parking assistance systems" chapter.

Turning the car wash view on/off

-  To turn on car wash view, press the Park Assist key on the switch cluster.
The parking assistance systems view is displayed.
- In the upper selection area, select the following camera view: "Car wash".

To exit car wash view, select another camera view from the selection at the top.

Display

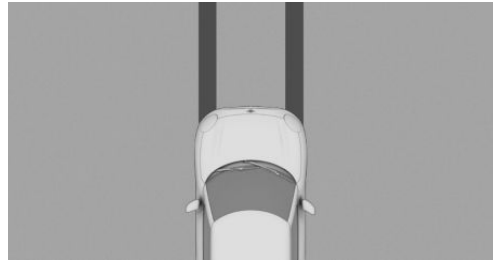

Your own lane is displayed for easier driving into a car wash.

This view can be used to position the vehicle correctly within the washing system guide rails.

In a car wash, the vehicle must be able to roll freely forward.

Additional information:

Rolling or pushing the vehicle, refer to page [119](#).

Panorama View

Principle

The panoramic view gives you an earlier view of crossing traffic at blind driveway exits and intersections.

Road users concealed by obstacles to the left and right of the vehicle can only be detected relatively late from the driver's seat. To provide greater visibility, the front camera and, depending on vehicle equipment, rearview camera cover the side of the vehicle.

Depending on vehicle equipment, this function can be used when reversing or driving forward.

Panorama view can be turned on/off using the Interaction Unit.

Depending on vehicle equipment, this function can be activated automatically by saving activation points.

General information

The camera image shows different levels of distortion in some areas and is thus not suitable for distance estimations.

Follow the information in the "Parking assistance systems" chapter.

Sensors

Panorama view is controlled by the following sensors:

- Rearview camera.
- Depending on if vehicle is equipped with front camera.

Turning the panoramic view on/off

1.  To turn on panorama view, press the Park Assist key on the switch cluster.

The parking assistance systems view is displayed.

2. In the upper selection area, select the following camera view: "Panorama".

To exit panorama view, select another camera view from the selection at the top.

Display

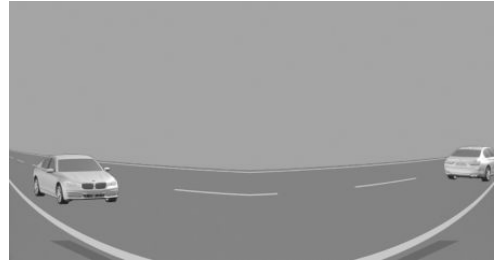

Yellow lines on the screen display identify the bumpers of your own vehicle.

When reverse gear is engaged, the reversing camera view is displayed. Depending on vehicle equipment, the front camera view is displayed when forward gear is engaged.

Automatic activation of panorama view

Principle

Positions at which panorama view should switch on automatically can be saved as activation points.

Up to ten activation points can be saved and edited.

The activation points can be used when driving forward and, depending on national-market version, when reversing.

General information

Follow instructions in the Parking assistance systems chapter.



Functional requirements

The following functional requirements apply for automatic activation of panorama view:

- A GPS signal must be received.
- Depending on national-market version: A MINI ID or driver profile must be activated.
- The reversing camera and front camera must be installed.
- The direction of travel, the selector lever position, and the vehicle angle must match a stored activation point.

Storing activation points

Desired activation points can be saved.

1. Drive your vehicle to the location where you want panorama view to switch on automatically, then stop.



2. Press the Park Assist key on the switch cluster.

The parking assistance systems view is displayed.

3. Go through the menu as follows: "Panorama" / "Activation point" / "Save activation point".

Activation points are saved with the following information, for example:

- With the city/town.
- With the city/town and the street.
- A default name.

You can rename the location and street information created automatically.

Using activation points

To enable/disable the use of activation points, go through the menu as follows: Apps menu / "Vehicle" / "Driving settings" / "Driver Assistance" / "Parking" / "GPS-based".

Editing activation points

Activation points can be renamed or deleted, individually or collectively.

1.  Press the Park Assist key on the switch cluster.

The parking assistance systems view is displayed.

2. Go through the menu as follows: "Panorama" / "Manage points".

A list of all saved activation points is displayed.

- To edit an activation point, press and hold the desired activation point.
- To delete an activation point, swipe over the desired activation point.

Door opening angle

Principle

Depending on vehicle equipment, the door opening angle display is shown automatically when stationary.

This display helps estimate how far the doors can be opened when parking.

If obstacle marking is activated, the parking view indicates fixed obstacles that obstruct the opening angles of the doors.

General information

Follow the information in the "Parking assistance systems" chapter.

Display

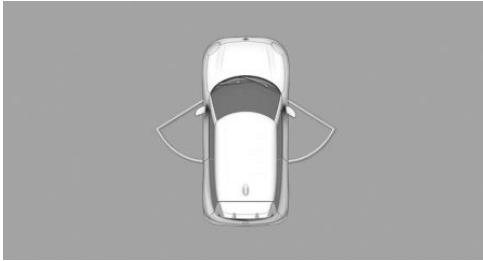

The maximum opening angle of the doors is displayed in selector lever position P.

System limits

The door opening angle view does not warn you of approaching road users.

The vehicle's surroundings are distorted in the display for technical reasons.

Even if no objects are visible in the door opening angle view on the Interaction Unit, park carefully when near other objects.

Because of the perspective, higher, protruding objects may be closer than they appear on the Interaction Unit.

Remote 3D View

Principle

The MINI app and parking camera views, e.g., automatic camera perspective, can be used to display the vehicle's surroundings on a mobile device.

Remote 3D View shows a snapshot of the situation.

General information

For reasons of data protection, Remote 3D View can only be used three times within two hours.

Follow the information in the "Parking assistance systems" chapter.

Sensors

Remote 3D View is controlled by the following sensors:

- Front camera.
- Exterior mirror cameras.
- Rearview camera.

Functional requirements

The following functional requirements apply for Remote 3D View:

- Data transfer must be activated.
- The MINI app must be installed on the mobile end device.
- In MINI Connected countries, an existing MINI Connected account must be used to activate a MINI ID.

Additional information:

- Data protection, refer to page 59.
- MINI ID, refer to page 60.

Activating/deactivating Remote 3D View

Remote 3D View can be activated or deactivated individually or together with other functions.

1. Go through the menu as follows: Apps menu / "All" / "Data privacy".
2. Select the desired setting.
After activating, Remote 3D View can be accessed in the MINI app.

Functional limitations

Remote 3D View may not be fully operational or may not be available in the following situations:



- With a door or the cargo area open. Dark fields in the display indicate areas that are not recorded by the system.
- With manually folded-in exterior mirrors.
- When other camera functions are being performed in the vehicle.
- The vehicle moves faster than walking speed.
- In case of missing or weak Internet connection.

Park Distance Control

Principle

Park Distance Control assists with parking. Acoustic and visual warnings signal obstacles in front of or behind the vehicle.

Obstacles that are detected by the side ultrasonic sensors can also be reported.

The range of Park Distance Control, depending on obstacles and environmental conditions, is approx. 6 ft/2 m.

Park Distance Control turns on and off automatically in certain situations: The Interaction Unit is used to enable/disable automatic activation.

General information

Follow the information in the "Parking assistance systems" chapter.

Safety information

Warning

The system cannot serve as a substitute for the driver's personal judgment in assessing the traffic situation. Based on the limits of the system, it cannot independently react to all traffic situations. There is a risk of accident, injury, or property

damage. Adjust driving style to traffic conditions. Watch the surrounding traffic situation closely, be ready to take over steering and braking at any time, and actively intervene where appropriate.

Warning

Due to high speeds when the Park Distance Control is activated, the warning can be delayed due to physical circumstances. There is a risk of injury or risk of damage to property. Avoid approaching an object too fast. Avoid driving off quickly while Park Distance Control is not yet active.

Sensors

Park Distance Control is controlled by the following sensors:

- Ultrasonic sensors in the front/rear bumpers.
- Ultrasonic sensors at the sides.

Turning Park Distance Control on/off

Turning on the system automatically

Park Distance Control switches on automatically in the following situations:

- When drive-ready state is switched on when selector lever position R is engaged.
- While approaching detected obstacles if the speed is lower than approx. 2.5 mph/4 km/h. The activation distance depends on the situation in question.

To activate/deactivate automatic activation when obstacles are detected, go through the menu as follows: Apps menu / "Vehicle" / "Driving settings" / "Driver Assistance" / "Parking" / "Automatic PDC activation".

Turning off the system automatically

Park Distance Control switches off automatically when driving forward or if a certain distance or speed is exceeded.

Turning the system on/off manually



To manually turn on Park Distance Control, press the Park Assist key on the switch cluster.

The parking assistance systems view is displayed.

When the LED above the Park Assist key illuminates, the system is on. When the LED goes out, the system is off.

If the system is manually switched on when the reverse gear is engaged, the rearview camera image is displayed.

Depending on the national-market version, the system cannot be turned off manually when the reverse gear is engaged.

Acoustic warning

General information

An intermittent tone is given as acoustic warning for Park Distance Control to signal an approaching object. E.g., when an object is detected at the rear left of the vehicle, a sound is heard from the rear left speaker.

The shorter the distance to the object, the shorter the intervals of the intermittent tones.

An acoustic warning sounds in case of an impending collision at a distance to the object of approx. 27 in/70 cm.

For objects behind the vehicle, the acoustic warning is issued as early as a distance to the object of approx. 5 ft/1.50 m.

When the distance to a detected object is less than approx. 8 in/20 cm, a continuous tone is sounded.

When there are objects in front of and behind the vehicle at the same time, at a distance smaller than approx. 8 in/20 cm, an alternating continuous tone will sound between the front and rear speakers.

The intermittent tones and the continuous tone are turned off when selector lever position P is engaged.

Depending on national-market version, the intermittent tones are switched off after a short time when the vehicle is stationary.

If an object approaches when the vehicle is stationary, the acoustic signal is reactivated.

Adjusting the volume

1. To adjust the volume of the acoustic warning, go through the menu as follows: Apps menu / "Vehicle" / "Driving settings" / "Driver Assistance" / "Parking" / "PDC signal volume".
2. Set the desired value.

Depending on national-market version: Turn off acoustic warning

Depending on national-market version, the acoustic warning can be turned off while performing a parking maneuver.

 Tap the acoustic warning icon on the right edge of the Interaction Unit. The icon turns gray and the LED below the icon goes out.

When the Park Distance Control is switched on again, the acoustic warning is automatically switched on again.

Visual warning

General information

If Park Distance Control is activated, the Interaction Unit will indicate when the vehicle is approaching an object.

Objects that are farther away are already displayed before a signal sounds.

Depending on the view, pathway lines, turning circle lines and obstacle markings are shown for a better estimation of the space required.

Depending on vehicle equipment, the sensor detection range is shown by the shaded, ring-shaped area. Green, yellow, and red markings indicate when obstacles are detected within the detection range.

If your vehicle is equipped with the Cross Traffic Warning, a warning is also shown on the display for vehicles approaching from the rear.

To protect the sides of the vehicle, obstacle markings are displayed on the sides of the vehicle.

Display

Depending on vehicle equipment, warnings may be displayed in front of, next to, and behind the vehicle.

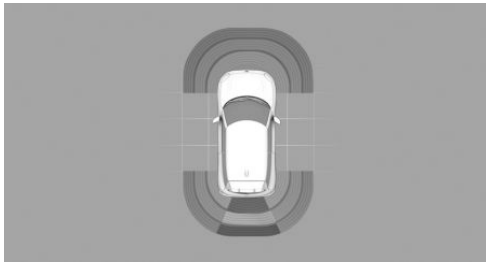

Example display of warnings behind the vehicle.



Example display of warnings next to the vehicle.

The shaded area indicates the sensor detection range.

If this area is shaded gray, no obstacles have been detected within the detection range.

Colored markings in the shaded area indicate that obstacles have been detected within the detection range.

If the shaded area is not continuous, the area next to the vehicle has not been scanned yet.

System limits

General information

The function for protecting the vehicle sides only shows stationary obstacles that were previously detected by the sensors when passing by.

Park Distance Control does not detect when an obstacle moves later. When the vehicle is stationary, the gray shaded areas on the sides are hidden after a certain time. The area on the side of the vehicle must be newly captured.

Also follow the information on system limits in the "Parking assistance systems" chapter.

Unwarranted warnings

Unwarranted warnings may be given if the system limits of Park Distance Control are reached.

To prevent unwarranted warnings, for instance in car washes, turn off automatic Park Distance Control activation on obstacle detection.

Malfunction



If Park Distance Control malfunctions, the Attention icon appears on the Interaction Unit.

Depending on vehicle equipment, the sensor detection range may not be shown.

A Check Control message is displayed. Park Distance Control has failed. Have the vehicle checked by an authorized service center or another qualified service center or repair shop.

Active Park Distance Control

Principle

Active Park Distance Control is the brake function of Park Distance Control and initiates emergency braking in the event of an acute risk of collision.

The system can be used below walking speed when reversing or coasting backward.

Due to system limits, a collision cannot be prevented under all circumstances.

Pressing the accelerator pedal interrupts the brake intervention. Emergency braking is not performed.

The Interaction Unit can be used to temporarily deactivate Active Park Distance Control as well as configure the settings for this system.

General information

Follow the information in the "Parking assistance systems" chapter.

Safety information

Warning

The system cannot serve as a substitute for the driver's personal judgment in assessing the traffic situation. Based on the limits of the system, it cannot independently react to all traffic situations. There is a risk of accident, injury, or property damage. Adjust driving style to traffic conditions. Watch the surrounding traffic situation closely, be ready to take over steering and braking at any time, and actively intervene where appropriate.

Sensors

Active Park Distance Control is controlled by the following sensors:

- Ultrasonic sensors in rear bumpers.
- Ultrasonic sensors at the sides.

Driving off after emergency braking

After emergency braking to a stop, further creeping toward an obstacle is possible. Proceed with caution. To move forward, lightly press the accelerator pedal and release as needed.

If the accelerator pedal is depressed longer, the vehicle drives off. Manual braking is possible at any time.

Deactivating Active Park Distance Control temporarily

After emergency braking, Active Park Distance Control can be temporarily deactivated on the Interaction Unit. A corresponding message is displayed.

Go through the menu as follows: "Configure" / "Deactivate temporarily".



No further emergency braking will be performed in this situation as you continue driving.

The function is automatically reactivated when Park Distance Control is switched on again.

Settings

You can configure which areas of your vehicle to protect with the Park Distance Control system.

1. Go through the menu as follows: Apps menu / "Vehicle" / "Driving settings" / "Driver Assistance" / "Parking" / "Active PDC emergency braking".
2. Select the desired setting.

Display



As soon as the system engages, an icon is displayed with a corresponding message.

System limits

General information

Follow the system limits in the "Parking assistance systems" chapter.

Drive-off monitoring

Principle

In case of a risk of collision, the start-up monitoring reduces the drive power when driving off.

When obstacles are detected in close range in front of the vehicle, the acceleration will be reduced. If necessary, this permits timely manual braking.

When obstacles are detected behind the vehicle, the system will brake.

Drive-Off Monitoring can be activated/deactivated on the Interaction Unit.

You can cancel reduced acceleration, e.g., by pressing the accelerator twice.

General information

Follow the information in the "Parking assistance systems" chapter.

Safety information

Warning

The system cannot serve as a substitute for the driver's personal judgment in assessing the traffic situation. Based on the limits of the system, it cannot independently react to all traffic situations. There is a risk of accident, injury, or property damage. Adjust driving style to traffic conditions. Watch the surrounding traffic situation closely, be ready to take over steering and braking at any time, and actively intervene where appropriate.

Sensors

Drive-off monitoring is controlled by the following sensors:

- Ultrasonic sensors in the front/rear bumpers.
- Ultrasonic sensors at the sides.

Functional requirements

The following functional requirements apply for drive-off monitoring:

- Selector lever position D or R is engaged when the vehicle is stationary.
- Obstacles in the immediate vicinity are detected in front of or behind the vehicle.

- The accelerator pedal is heavily applied, nearly to the end point.
- The accelerator pedal is immediately applied after engaging the selector lever position and obstacle detection.

Activating/deactivating Drive-Off Monitoring

To activate/deactivate Drive-Off Monitoring, go through the menu as follows: Apps menu / "Vehicle" / "Driving settings" / "Driver Assistance" / "Parking" / "Drive off monitoring".

A Check Control message is displayed where applicable.

Depending on national-market version, this system turns on automatically for the next drive.

Canceling reduced drive power

The reduction of the drive power is canceled in the following situations:

- The accelerator pedal is released.
- After the accelerator pedal has been depressed completely twice.
- A specific distance has been traveled.

If the reduction in drive power is canceled by covering a certain distance, the drive power is released gradually.

Display



As soon as the system engages, an icon is displayed with a corresponding message.

System limits

General information

Follow the system limits in the "Parking assistance systems" chapter.

Automatic Parking Assistant

Principle

Automatic Parking Assistant provides support when parallel parking and parking transverse to the road.

In addition, the system makes it easier to park out of parallel and perpendicular parking spaces.

The ultrasonic sensors measure both sides of the vehicle when driving slowly forward. Suitable parking spaces are calculated based on the objects detected, e.g., parking vehicles. The system status is displayed.

The system calculates the best possible parking line for driving in or out of parking spaces, and takes control of the vehicle while parking.

The operating principle and operation of Park Assist is divided into the following steps:

- Parking space search.
- Turning on.
- Parking.
- Driving out of parking spaces.

The parking manoeuvre while parking is performed automatically.

When driving out of parallel parking spaces, the vehicle maneuvers automatically until it reaches a position where it can be driven out of the parking space without further steering movements.

When driving out of perpendicular parking spaces, the vehicle is maneuvered out of the parking space to enable continued driving in the desired direction.

A parking maneuver can be interrupted and continued manually.

Settings can be customized as desired, e.g., to adjust how parking maneuvers are displayed or to set a sound for suitable parking spaces.

General information

Follow the information in the "Parking assistance systems" chapter.

Safety information

Warning

The system cannot serve as a substitute for the driver's personal judgment in assessing the traffic situation. Based on the limits of the system, it cannot independently react to all traffic situations. There is a risk of accident, injury, or property damage. Adjust driving style to traffic conditions. Watch the surrounding traffic situation closely, be ready to take over steering and braking at any time, and actively intervene where appropriate.

Warning

The system can steer the vehicle over or onto curbs. There is a risk of injury or risk of damage to property. Watch surrounding traffic closely and actively intervene where appropriate

Parking methods

Park Assist supports the following functions:

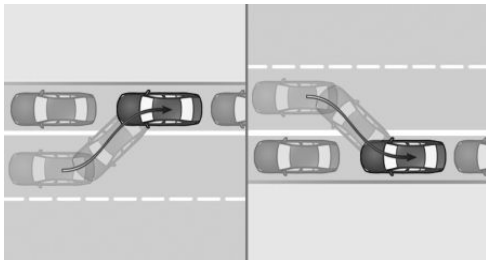

When parallel parking: Parking in reverse, parallel to the road.

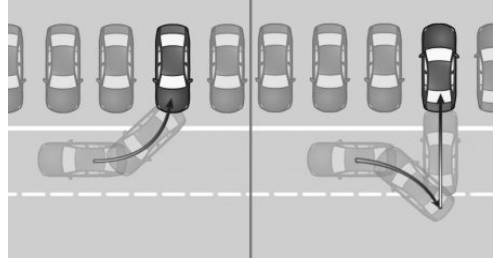

When perpendicular parking: Parking forward or in reverse, perpendicular to the road.

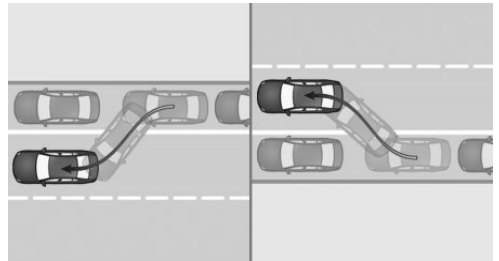

When driving out of parallel parking spaces.

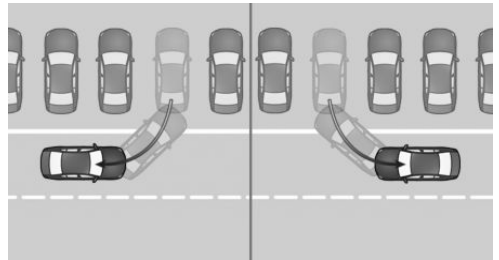

When driving out of perpendicular parking spaces.

Sensors

The Automatic Parking Assistant is controlled by the following sensors:

- Ultrasonic sensors in the front/rear bumpers.
- Ultrasonic sensors at the sides.

Functional requirements

Measurement of parking spaces

The following functional requirements apply when measuring parking spaces:

- Driving forward: up to approx. 22 mph/35 km/h.
- Maximum distance to row of parked vehicles: approx. 5 ft/1.5 m.

Suitable parking space

The following functional requirements apply for suitable parking spaces:

Longitudinal parking:

- Minimum length of detected object, e.g., parking vehicle: approx. 3 ft/1 m.
- Minimum length of gap between two objects: vehicle length plus approx. 2.6 ft/0.8 m.
- Minimum depth: approx. 5 ft/1.5 m.

Perpendicular parking:

- Minimum length of detected object, e.g., parking vehicle: approx. 3 ft/1 m.
- Minimum width of gap: vehicle width plus approx. 2.3 ft/0.7 m.
- The minimum depth corresponds to your vehicle's length.

The depth of perpendicular parking spaces must be estimated by the driver. Due to technical limitations, the system is only able to approximate the depth of perpendicular parking spaces.

Parking operation

The following functional requirements apply when pulling into a parking space:

- The doors and cargo area are closed.
- The driver's seat belt is fastened.

Leaving parking spaces

The following functional requirements apply when pulling out of a parking space:

- The vehicle was parked using the Automatic Parking Assistant, and an object has been detected in the area around the vehicle.
- The vehicle was manually parked in reverse, and objects have been detected in the immediate vicinity of the vehicle. The distance to a detected curb is at least 6 inches/15 cm.
- The parking space is at least 2.6 ft/0.8 m longer than the vehicle.

Displays





General information

The current status of the Automatic Parking Assistant is shown on the Interaction Unit and Head-up display, depending on vehicle equipment.

Various icons are shown when selecting the parking method.

The sequence of the displayed icons corresponds to the prioritized parking option.

The direction of the arrow changes for the icons for parking methods for driving out of a parking space.

Icon	Meaning
	Reverse lengthwise parking, right.
	Reverse lengthwise parking, left.
	Reverse perpendicular parking.
	Forward perpendicular parking.



Turning parking operation display on/off

When the Automatic Parking Assistant is enabled, the parking maneuver is displayed in the camera view on the Interaction Unit.

To turn the parking maneuver display on/off, go through the menu as follows: Apps menu / "Vehicle" / "Driving settings" / "Driver Assistance" / "Parking" / "Show assistance information".

Turning the signal tone on/off

To turn the signal tone for suitable parking spaces on/off, go through the menu as follows: Apps menu / "Vehicle" / "Driving settings" / "Driver Assistance" / "Parking" / "Sound when available".

Parking using the Automatic Parking Assistant

When parking with Park Assist, you must select a parking method depending on the available parking spaces.

1. For the parking space search when driving past parked vehicles at a speed of up to approx. 22 mph/35 km/h and a distance of max. 5 ft/1.5 m.

 The parking space search is activated.

2.  Press the Park Assist key on the switch cluster or engage reverse gear. The parking assistance systems view is displayed.

The parking space search and possible parking spaces are shown on the Interaction Unit.

3. Select one of the parking methods offered on the Interaction Unit. You can switch to another parking maneuver as necessary.

 The status symbol for the Automatic Parking Assistant illuminates green. The system takes control of the parking operation.

4. Follow the instructions on the Interaction Unit.

The speed can be reduced with the brake. Other interventions will cancel the system.

Depending on national-market version, an intermittent or continuous tone sounds for Park Distance Control.

At the end of the parking operation, selector lever position P is set.

The end of the parking maneuver is indicated on the Interaction Unit.

5. Adjust the parking position yourself, if needed.

Driving out of a parking space using the Automatic Parking Assistant

1. Switch on drive-ready state to pull out of the parking space using Park Assist.



2.  When your vehicle is stopped, press the Park Assist key on the switch cluster or engage reverse gear.

The parking assistance systems view is displayed.

3. On the Interaction Unit, select the desired parking method.
4. Follow the instructions on the Interaction Unit.

 The status symbol for the Automatic Parking Assistant illuminates green. The system takes control of the maneuver.

The speed can be reduced with the brake. Other interventions will cancel the system.

A message will be displayed at the end of the maneuver.

5. Make sure that the traffic situation permits driving out of parking space and driving off as usual.

The Automatic Parking Assistant is turned off automatically.

Canceling Automatic Parking Assistant manually

The Automatic Parking Assistant can be canceled manually at any time, e.g.:

- Step lightly on the accelerator pedal twice in succession.
- Step lightly on the accelerator pedal and move the steering wheel slightly at the same time.
- Depress the brake pedal and operate the selector lever at the same time.

The Automatic Parking Assistant is canceled without engaging selector lever position P. Driving can continue immediately.

Canceling Automatic Parking Assistant automatically

Park Assist is canceled automatically in situations such as the following:

- When the driver grasps the steering wheel or takes over steering.
- When operating the accelerator pedal or the selector lever.
- When setting the parking brake.
- When unfastening the driver's seat belt.
- With open cargo area.
- With open hood.
- With the doors open.
- During activation or intervention by driver assistance systems.
- When switching to other functions on the Interaction Unit.

- When overlaying messages on the Interaction Unit display.
- On snow-covered or slippery road.
- On steep uphill or downhill grades.
- When there are obstacles that are hard to overcome such as curbs.
- When there are obstacles that suddenly appear.
- With insufficient distances, which are indicated by Park Distance Control.
- When a maximum number of parking attempts or the time taken for parking is exceeded.

When the system is automatically aborted, selector lever position P is engaged.

A Check Control message is displayed where applicable.

Continuing the parking operation

If parking or leaving a parking space has been interrupted, the operation can be continued, if needed.

Restart the Automatic Parking Assistant and follow the instructions on the Interaction Unit.

System limits

General information

Follow the system limits in the "Parking assistance systems" chapter.

No parking assistance

The Automatic Parking Assistant does not offer assistance in the following situations:

- In tight curves.
- For diagonal parking spaces.



- For parking spaces that are only marked with lines on the ground. The system orients itself according to objects.
- For special parking spaces, e.g., metered parking spaces with automatic locking mechanisms, or mechanical parking systems.

Functional limitations

Park Assist may be restricted in the following situations:

- On bumpy road surfaces such as gravel roads.
- On slippery ground.
- On steep uphill or downhill grades.
- With accumulations of leaves/snow in the parking space.
- In case of changes to an already-measured parking space.
- With ditches or edges, for instance an edge of a port.
- Parking spaces that are not suitable may be detected or suitable parking spaces may not be detected at all.

Malfunction

A Check Control message is displayed.

The Automatic Parking Assistant has malfunctioned. Have the vehicle checked by an authorized service center or another qualified service center or repair shop.

Back-up assistant

Principle

The Back-up Assistant helps when reversing, e.g., when pulling out of tight or unclear parking or road situations.

The vehicle stores the driving movements of the last distance covered. This stored

distance can be driven in reverse with automated steering.

The Reversing Assistant takes control of steering. The driver must control the speed using the accelerator and brake pedals.

With Back-up Assistant: a maximum distance of 164 ft/50 m is saved.

General information

Follow the information in the "Parking assistance systems" chapter.

Safety information

Warning

The system cannot serve as a substitute for the driver's personal judgment in assessing the traffic situation. Based on the limits of the system, it cannot independently react to all traffic situations. There is a risk of accident, injury, or property damage. Adjust driving style to traffic conditions. Watch the surrounding traffic situation closely, be ready to take over steering and braking at any time, and actively intervene where appropriate.

Warning



The system can steer the vehicle over or onto curbs. There is a risk of injury or risk of damage to property. Watch surrounding traffic closely and actively intervene where appropriate.

Functional requirements

The following functional requirements apply for the Reversing Assistant:

- Drive forward without interruption to store the distance covered.
- To store the distance covered, do not drive faster than 22 mph/35 km/h.

Driving in reverse with automated steering

- To reverse with automatic steering, switch on drive-ready state.
-  When your vehicle is stopped, press the Park Assist key on the switch cluster or engage reverse gear.
The parking assistance systems view is displayed.
- On the bottom toolbar, select the following function: "Back-up Assistant".
The length of the saved distance is displayed on the Interaction Unit.
Follow the instructions on the Interaction Unit as necessary.
- Take your hands off the steering wheel and carefully drive in reverse with the accelerator pedal and the brake.
 The status symbol for the Back-up Assistant illuminates green. The system takes over the steering.
When driving in reverse, observe the vehicle's surroundings.
In case of obstacles, stop immediately and take over control of the vehicle. Follow the instructions for Park Distance Control.
- Right before the end of the stored distance covered, a signal tone will sound and a message is displayed.
Stop no later than when normal road traffic is reached and take control of the vehicle such as by shifting to forward gear.

Canceling the Back-up Assistant manually

The assisted reversing by the Back-up Assistant can be canceled manually:

- On the bottom toolbar, select the following function: "Cancel".
-  Press the Park Assist key on the switch cluster.

Canceling the Back-up Assistant automatically

The Reversing Assistant is canceled automatically in situations such as the following:

- When the driver grasps the steering wheel or takes over steering.
- When shifting from reverse gear to another selector lever position.
- During activation or intervention by driver assistance systems.
- After an extended period of time when the vehicle is stationary.
- When exiting the stored lane when reversing, for instance with maximum steering-wheel angle.
- When overlaying messages on the Interaction Unit display.
- In case of a slippery surface.
- When the vehicle is rolling such as on a slope.
- In case of changed ambient conditions.
- If the vehicle speed exceeds approx. 6 mph/10 km/h.

System limits

Speed threshold

The maximum speed when reversing is limited to approx. 6 mph/10 km/h.

A warning is issued at a speed of approx. 4 mph/7 km/h.

If the maximum speed is exceeded, the function is interrupted.



Functional limitations

Different influences can lead to side deviations when driving the stored distance covered in reverse. For example, this includes the following factors:

- Steering movements when the vehicle is stationary while storing the distance covered.
- The speed is not adapted to the distance covered.
- Certain road characteristics such as gradients, inclines or slippery road surface.
- Greatly deviating conditions when storing and driving the route, for instance other tires or changed ambient conditions like weather.

Also follow the information on system limits in the "Parking assistance systems" chapter.

Driving comfort

Vehicle features and options

This chapter describes model-specific equipment, systems, and functions that are currently available, or may become available in the future, even if they are not present in the vehicle.

Additional information:

Vehicle equipment, refer to page 8.

Adaptive suspension

The adaptive suspension is a variable, mechanically controlled sport suspension that reduces movement of the vehicle body while driving with a sporty style or on uneven roads.

Driving dynamics and driving comfort are increased through the adjustment of the chassis.

MINI Sound

Depending on vehicle equipment and national-market version, the vehicle drive sound can be adjusted using MINI Sound.

1. To configure MINI Sound, go through the menu as follows: Apps menu / "Vehicle" / "Driving settings" / "Drivetrain and chassis" / "MINI Sound".
2. Select the desired setting.

Climate control

Vehicle features and options

This chapter describes model-specific equipment, systems, and functions that are currently available, or may become available in the future, even if they are not present in the vehicle.

Additional information:







Vehicle equipment, refer to page 8.







Climate control

Overview

Functions in the Climate menu

Some climate control functions, e.g., seat heating or air flow, can be configured using the Climate Control menu on the Interaction Unit.



Icon	Function
	Turn the climate control system on/off.
	Automatic program.
	Temperature.
	Air flow.
	Air distribution.
	Air conditioning.

Icon	Function
	Maximum cooling.
	Air recirculation mode.
	Automatic recirculated-air control.
	Fresh air.
	SYNC program.
	Seat heating.
	Steering wheel heating.

Buttons, automatic climate control



The defrost and rear window heating functions can be turned on/off using the switch cluster.

Icon	Function
	Defrost function.
	Rear window defroster.

Calling up climate control functions

Access the Climate menu via the Interaction Unit:



 Select the Climate menu icon on the menu bar.

Or:

Go through the menu as follows: Apps menu / "Vehicle" / "Climate control".

Turning the air conditioning system on/off

The climate control system can be turned on/off using the Interaction Unit.



-  Select the Climate menu icon on the menu bar.
-  Tap the power button.

The entire climate control system is turned on or off with the last settings applied.

When the air conditioning system is turned on, individual climate control functions can be turned off.

Settings

Individual settings for climate control functions, e.g., seat heating intensity, can be configured using the Interaction Unit.

-  To configure the climate control functions individually, select the icon for the Climate Control menu on the menu bar.
-  Tap the settings button.
- Select the desired setting.

Automatic program

Principle

The automatic program ensures a comfortable climate, which can be modified with the desired temperature and individual settings.

The AUTO program cools, ventilates, and heats the vehicle interior automatically.

Depending on the equipment, the automatic program provides the best possible settings for climate control functions depending on the outside temperature, interior temperature, sunlight, seat occupancy and the desired temperature setting:

- Air flow.
- Air distribution.
- Temperature.
- Seat heating.
- Steering wheel heating.

General information

The automatic program takes seat occupancy into account, regulating the climate in an energy-efficient manner that is tailored to the occupants.

At the same time, a condensation sensor controls the automatic program in order to prevent window condensation to the extent possible.



Overview



- 1 Temperature
Seat heating
Steering wheel heating
- 2 Air flow intensity
- 3 Climate control functions bar
- 4 Settings

Turning the automatic program on/off



The AUTO program can be turned on/off using the Interaction Unit.

1.  Select the Climate menu icon on the menu bar.
2.  Tap the automatic program button.

Setting the intensity

When the automatic program is activated, the intensity of individual climate control

functions, e.g., seat heating, is adjusted individually.

1.  Select the Climate menu icon on the menu bar.
2.  Tap the settings button.
3. Select the desired setting.

Each level has a specific control range of the intensity.

Based on the stored data models, the intensities are dynamically adjusted while driving. It is not necessary to manually change the desired intensity to lower or higher levels while driving.

Custom settings for climate control functions are saved and applied automatically, e.g., after the vehicle is started.

Display

The indicator on the temperature display provides information about the temperature difference between the set desired temperature and the current interior temperature.

- The flashing red or blue bar next to the temperature display indicates that the interior temperature is being adjusted.
- Once the bar stops flashing, the desired interior temperature has been reached.

Temperature

Principle

The automatic climate control cools or heats to the configured temperature and then keeps the temperature constant.

Setting the temperature

The driver and front passenger can each adjust the temperature as they prefer.

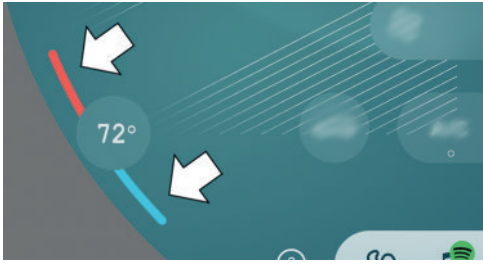

1. Tap the button with temperature display.
2. Set the desired temperature.
 - + Raise the temperature.
 - – Lower the temperature.

Do not rapidly switch between different temperature settings. Otherwise, the automatic climate control will not have sufficient time to adjust the set temperature.

Air flow



Principle

The air flow generated by the blower can be adjusted as needed.

The air flow may be reduced to preserve the vehicle battery.

Adjusting the air flow

The air flow can be configured using the Interaction Unit:

1.  Select the Climate menu icon on the menu bar.
2. Select the desired setting.
 -  Tap the large air flow icon to increase the air flow.
 -  Tap the small air flow icon to reduce the air flow.

Air distribution settings

Principle

The air distribution can be adjusted as required in manual mode.

Adjusting the air distribution

The air distribution can be adjusted via the Interaction Unit:

1.  Select the Climate menu icon on the menu bar.
2. Select the desired setting:
 - Aim the air flow downward, arrow 1.
 - Aim the air flow upward, arrow 2.
 - Aim the air flow at the windshield, arrow 3.

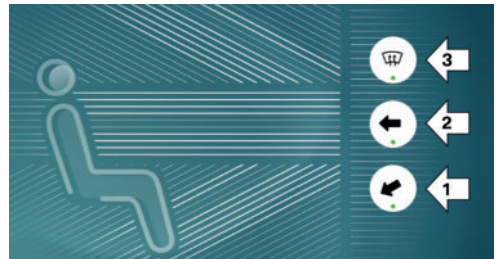

The selected air distribution is displayed.

Air conditioning

Principle

With the climate control function, the air inside the vehicle is cooled and dehumidified, then warmed again depending on the temperature settings.



Functional requirement

The climate control function can be used with standby or drive-ready state.



Switching the cooling function on/off

The air conditioning can be turned on/off using the Interaction Unit:

-  Select the Climate menu icon on the menu bar.
-  Tap the climate control function button.

In recirculated-air mode, the air conditioning is automatically turned on to dry the air and avoid window condensation.

Depending on the weather, the windshield and the side windows may fog up briefly when drive-ready state is switched on.

When using the cooling mode, condensation that will exit below the vehicle.

Maximum cooling

Principle

Maximum cooling is used to cool the vehicle interior quickly and effectively.



The lowest temperature and the maximum air flow are set automatically.

Functional requirement

Maximum cooling can be used when the outside temperature exceeds approx. 32 °F/0 °C and when drive-ready state is on.

Turning maximum cooling on/off

Maximum cooling can be turned on/off using the Interaction Unit:

-  Select the Climate menu icon on the menu bar.
-  Tap the maximum cooling button.

The air vents open. Air flows out of the air vents to the upper body area.

Air recirculation mode

Principle

With air recirculation, if unpleasant odors or pollutants are detected in the outside air, the outside air supply can be temporarily stopped. The system then recirculates the interior air.

With automatic air recirculation, outside air is fed in, or the interior air is recirculated, depending on the outside air quality.

When air recirculation is off, outside air is channeled into the interior.





The interior filter cleans the incoming fresh air or the circulated interior air in recirculation mode.

General information

If there is window condensation, turn off the air recirculation.

Turning air recirculation on/off

Air recirculation can be turned on/off using the Interaction Unit:

-  Select the Climate menu icon on the menu bar.
- The current operating mode is displayed on the climate control functions bar. Tap the button and select the desired operating mode.
 -  Recirculating air.
 -  Fresh air.
 -  Automatic recirculated-air control.

In recirculated-air mode, the air conditioning turns on automatically to dry the air and prevent condensation.

Depending on vehicle equipment, the air recirculation turns off automatically after some time based on the ambient conditions in order to prevent condensation.

SYNC program

Principle



If SYNC program is activated, the temperature settings on the driver's side are transferred to the passenger's side.

If the SYNC program is deactivated, the following settings are made automatically in the automatic program depending on the seat occupancy:

If the front passenger's seat is not occupied, the settings on the driver's side are applied.

Turning the SYNC program on/off

The SYNC program can be turned on/off using the Interaction Unit:

-  Select the Climate menu icon on the menu bar.
-  Tap the SYNC program button.

If the temperature settings for the front passenger's side are changed, the SYNC program turns off automatically.

Defrost function

Principle

With the defrost function, ice and condensation are quickly removed from the windshield and the front side windows.

The air flow and air temperature are automatically optimized for the removal of ice and condensation.

The air distribution is directed toward the windshield and front side windows.

If there is window condensation, turn on the automatic program to take advantage of the condensation sensor.

Turning the defrost function on/off

-  To turn the defrost function on/off, press the defrost button on the switch cluster.

The LED of the button is illuminated when the system is switched on.

Make sure that air is able to flow to the windshield and front side windows.



Rear window defroster

Principle

With the rear window defroster, ice and condensation are quickly removed from the rear window.

Functional requirement

The rear window heating can be used when standby or drive-ready state is on.

Turning the rear window defroster on/off



To turn the rear window heating on/off, press the rear window heating button on the switch cluster.

The LED illuminates when the rear window heating is turned on.

The rear window defroster switches off automatically after a certain period of time.

Seat heating

Principle

When the seat heating is used, seats are heated depending on the outside temperature and the interior temperature.

The intensity can be stored using the automatic program. This function can be adjusted as necessary.

General information

If the trip is continued within approx. 15 minutes after an intermediate stop, the functions are turned on automatically with the temperature that was last set.

Adjusting seat heating

Automatic program

When the automatic program is activated, the intensity of seat heating can be adjusted: As you drive, the heater output is automatically adjusted according to your set intensity.

Adjusting seat heating manually

The heater output level can be adjusted manually:

1. Tap the button with temperature display.

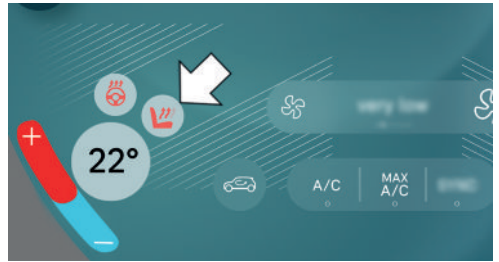

2. Press the seat heating button repeatedly until the desired level is selected, arrow.

If a consumption-optimized drive mode is selected, the heater output is reduced.

Steering wheel heating

Principle

When the steering wheel heating is used, the steering wheel is heated depending on the outside temperature and the interior temperature.

The intensity can be stored using the automatic program. This function can be adjusted as necessary.

Adjusting steering wheel heating

Automatic program

When the automatic program is activated, the intensity of steering wheel heating can be adjusted. As you drive, the heater output is automatically adjusted according to your set intensity.

Adjusting steering wheel heating manually

The heater output level can be adjusted manually:

1. Tap the button with temperature display.



2. Press the steering wheel heating button repeatedly until the desired level is selected, arrow.

If a consumption-optimized drive mode is selected, the heater output is reduced.

Ventilation

Principle

The ventilation system has different options for direct or indirect ventilation to optimize air flow in the vehicle.

The air flow heats or cools noticeably, depending on the set desired temperature.

Front ventilation

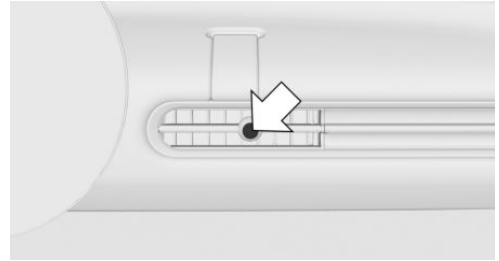

- To adjust the air flow direction, push the button in the desired direction.
- To adjust the air flow, turn the knob to open and close the vents variably.

Setting the ventilation

Depending on the desired ventilation, align the air flow directly or indirectly toward the passengers.

Open the air vents and position them to ensure effective climate control.

Air quality

General information

The following components improve the air quality inside the vehicle:

- Emissions-tested vehicle interior.
- Interior filter.
- Air conditioning system to control the temperature, air flow, and air recirculation.
- Pre-ventilation.

Interior filter

The interior filter cleans the incoming fresh air or the circulated interior air in recirculation mode.

Depending on the equipment:



- Dust and pollen is filtered out from the inflowing air.
- Nano-particle emissions are reduced.
- Gaseous pollutants are filtered.
- Microbial particles, viruses and allergens are filtered.

The manufacturer of the vehicle recommends having the interior filter changed during vehicle maintenance.

Pre-ventilation

Principle

Pre-ventilation is used to cool or heat the vehicle interior before beginning a drive. The vehicle interior is ventilated or heated as necessary using residual engine heat, depending on the set temperature and ambient temperature.

The system can be switched on and off directly or via a preset departure time.

The activation time is determined based on the outside temperature. The system promptly switches on before the selected departure time.

The system switches off automatically after a certain period of time. The system continues to run for some time after being switched off.

Functional requirements

The following functional requirements apply for pre-ventilation:

- The vehicle is in idle state or standby state.
- The vehicle battery is sufficiently charged.



If pre-ventilation is switched on, the vehicle battery will be discharged. Thus, limit the maximum activation time to save the vehicle battery. System can be

used again once engine is started or after a short drive.

- Time and date are set correctly.
- The ventilation air vents are open.

Turning pre-ventilation on/off

Pre-ventilation can be turned on/off using the Interaction Unit:

1.  Select the Climate menu icon on the menu bar.
2.  Tap the settings button.
3. "Pre-ventilation"
4. Select the desired setting.

Departure time

Principle

Different departure times can be set to ensure a comfortable interior temperature in the vehicle at the time of departure:

- One-time departure time: the time can be set.
The system is switched on once.
- Departure time with weekday: Time and day of week can be set.
On the desired weekdays, the system will be switched on before the set departure time.



The departure time is preselected in two steps:

- Set the departure time.
- Activate departure times.

Allow for at least 10 minutes between setting and activating the departure time and departing at the planned time. This gives the air conditioning sufficient time to prepare the vehicle interior.



Setting the departure time

The departure time can be set on the Interaction Unit:

1.  Select the Climate menu icon on the menu bar.
2.  Tap the settings button.
3. "Pre-ventilation"
4. "Departure plan"
5. Select the desired departure time.
6. Set the desired departure time.
7. Select the day of the week, as necessary.

Activating the departure time

The departure time can be activated on the Interaction Unit:

1.  Select the Climate menu icon on the menu bar.
2.  Tap the settings button.
3. "Pre-ventilation"
4. "Departure plan"
5. Activate the desired departure time.

Activating with the MINI app

Depending on vehicle equipment, the MINI app with remote functionality can be used to turn on preventilation at a preset departure time or immediately.

Pre-conditioning through Remote Engine Start

Principle

Pre-conditioning cools or heats the vehicle interior to a comfortable temperature prior to departure. This system automatically cools, ventilates, and heats depending on the inside/outside temperature and set temperature. Snow and ice may be removed more easily.

The system starts the engine automatically and allows it to run for a limited period of time.

Safety information

DANGER

If the exhaust pipe is blocked or ventilation is insufficient, harmful exhaust gases can pollute the area in and around the vehicle or penetrate the vehicle. The exhaust gases contain pollutants which are colorless and odorless. In enclosed areas or areas with insufficient ventilation, exhaust gases can also accumulate outside of the vehicle. There is a danger to life. Keep the exhaust pipe free and ensure sufficient ventilation. Do not switch on stationary climate control in enclosed areas or areas with insufficient ventilation, e.g. in enclosed garages.

Warning

When stationary climate control is in operation, high temperatures can occur underneath the body, for instance caused by the exhaust system. If combustible materials such as leaves or grass come in contact with hot parts of the exhaust system, these materials can ignite. There is a risk of fire. Make sure that no combustible mate-



Materials can come in contact with hot vehicle parts during stationary climate control operation, e.g. leaves, grass, gas, gasoline, oil or other combustible objects.

Functional requirements



The following functional requirements apply for pre-conditioning:

- The vehicle is in idle state or standby state.
- The battery is sufficiently charged.
- The tank capacity is sufficient.
- The hood is closed.
- Time and date are set correctly.
- The ventilation air vents are open.

Enabling the automatic engine start function

The automatic engine start must be enabled before using the system. Otherwise, the engine cannot switch on automatically to air-condition the vehicle interior.

Automatic engine start can be enabled on the Interaction Unit:

1.  Select the Climate menu icon on the menu bar.
2.  Tap the settings button.
3. "Pre-conditioning"
4. "Remote Engine Start"
5. "Start engine for climate control"
6. Confirm the legal disclaimer.

Turning on/turning off the pre-conditioning

General information



The pre-conditioning turns off automatically after max. 15 minutes for safety reasons.

The pre-conditioning can only be activated twice in a row.

Pre-conditioning can be used again as soon as drive-ready state is activated and then deactivated again.

Turning on pre-conditioning via the Interaction Unit

Pre-conditioning can be turned on/off using the Interaction Unit:

1.  Select the Climate menu icon on the menu bar.
2.  Tap the settings button.
3. "Pre-conditioning"
4. "Start now"

Switching on/off via vehicle key

Pre-conditioning can be turned on/off using the vehicle key.

1.  Press the button on the vehicle key three times within 1 second.
After operating the vehicle key, it takes approx. 3 seconds for the engine to switch on.

To turn off pre-conditioning, press the button again three times.

Switching off with the Start/Stop button

Pre-conditioning can be turned off directly by pushing the Start/Stop button without depressing the brake pedal.

Climate control for departure time

Principle

Scheduled departure times can be set up in the system to ensure a comfortable interior temperature in the vehicle at the time of departure:

- One-time departure time: the time of the scheduled departure can be set.

Pre-conditioning is turned on once.

- Departure time with weekday: Time and day of week for the scheduled departure can be set.

The departure time is preselected in two steps:

- Set the departure time.
- Activate departure times.

Pre-conditioning activates automatically a few minutes before the set departure time. Pre-conditioning stays on for a short time after the set departure time.

For safety reasons, the air conditioning can only be activated once for the departure time.

Pre-conditioning can be used again as soon as drive-ready state is activated and then deactivated again.



Observe the information about the intended use of the vehicle.

Additional information:

For Your Own Safety, refer to page 9.

Setting the departure time



The departure time can be set on the Interaction Unit:

-  Select the Climate menu icon on the menu bar.
-  Tap the settings button.

3. "Pre-conditioning"
4. "Departure plan"
5. Set the departure time.
6. Select the day of the week, as necessary.

Activating the departure time

The departure time can be activated on the Interaction Unit:

-  Select the Climate menu icon on the menu bar.
-  Tap the settings button.
3. "Pre-conditioning"
4. "Departure plan"
5. Activate the desired departure time.

Display



The activated pre-conditioning temperature is displayed on the instrument cluster.

The engine runs for the purpose of operating the pre-conditioning. The vehicle is not ready to drive.

Confirmation signals from the vehicle

Activation of the pre-conditioning is confirmed by the light flashing twice.

The parking light turns on while the pre-conditioning is on.



Interior equipment

Vehicle features and options

This chapter describes model-specific equipment, systems, and functions that are currently available, or may become available in the future, even if they are not present in the vehicle.

Additional information:

Vehicle equipment, refer to page 8.

Sun visor

Glare shield

To prevent glare, fold the sun visor up or down.

Glare shield from the side

Folding the sun visor out

To prevent glare from the side window, proceed as follows:

1. Fold down the sun visor.
2. Detach the sun visor from its mount and swing it toward the side window.

Folding the sun visor in

Proceed in the reverse order to close the sun visor.

Vanity mirror

A vanity mirror is located in the sun visor behind a cover.

Sockets

Principle

The socket can be used for electronic devices when the standby or drive-ready state is switched on.

General information

The total load of all sockets must not exceed 140 watts at 12 volts.

Do not damage the socket by using unsuitable connectors.

Safety information

Warning

Devices and cables in the unfolding area of the airbags such as portable navigation devices can hinder the unfolding of the airbag or be thrown around in the car's interior while unfolding. There is a risk of injury and risk of damage to property. Make sure that devices and cables are not in the airbag's area of unfolding.

Warning

Battery chargers that charge the vehicle battery via sockets or cigarette lighters in the vehicle may overload or damage the 12 V electrical system. There is a risk of injury or risk of damage to property. Only connect battery chargers for the vehicle battery to the jump-start terminals in the engine compartment.

⚠ Warning

If metal objects fall or are plugged into electronic interfaces, e.g., sockets or USB ports, these objects can cause a short circuit and destroy the interface. There is a risk of injury and risk of damage to property. Make sure to prevent metal objects from falling or being plugged into electronic interfaces. Insert the cigarette lighter or socket cover again after using the socket.

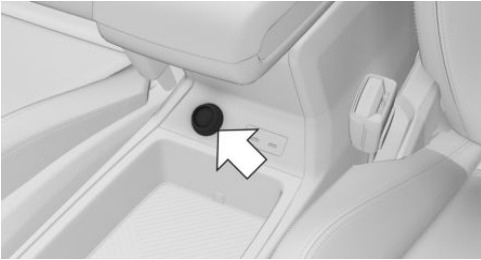
Front center console

A socket is provided on the center console under a cover. Pull off the cover before using the socket.

USB port**Principle**

The USB port is an interface used to connect mobile devices to the vehicle via USB cable. When connected, data can be sent or the mobile device can be charged.

General information

Follow the instructions for connecting mobile devices to the USB port given in section “USB connection”.

Additional information:

USB connection, see Owner's Manual for Navigation, Entertainment, Communication;

Safety information**⚠ Warning**

If metal objects fall or are plugged into electronic interfaces, e.g., sockets or USB ports, these objects can cause a short circuit and destroy the interface. There is a risk of injury and risk of damage to property. Make sure to prevent metal objects from falling or being plugged into electronic interfaces. Insert the cigarette lighter or socket cover again after using the socket.

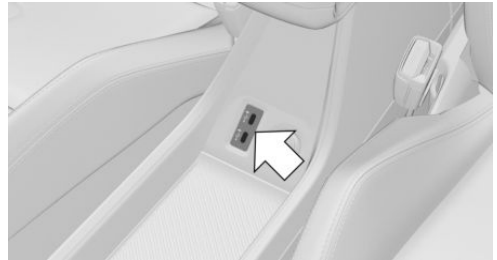
Front center console

Two USB ports are located on the front center console.

Properties:

- USB port Type C.
- For charging mobile devices and for data transfer.
- Charge current: maximum 3 A per port.

Wireless charging tray**Principle**

The wireless charging tray is used to wirelessly charge Qi-certified smartphones.

General information

Quick charging functions are supported depending on the smartphone.

The integrated fan cools the smartphone being charged.

When inserting the smartphone to be charged, make sure that there is nothing between the smartphone to be charged and the wireless charging tray.

(⚡) The charging process is shown by the charge indicator on the Interaction Unit.

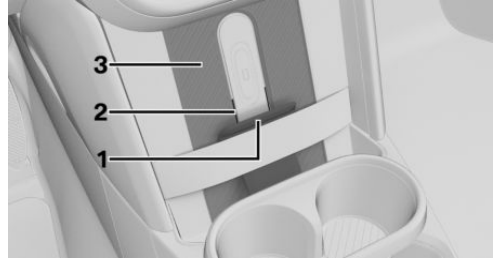

- 1 Car mount
- 2 Fan
- 3 Storage area

Safety information

⚠ Warning

When charging a Qi-compatible device in the wireless charging tray, any metal objects on the tray together with the device can become very hot. Storage media or electronic cards, e.g., chip cards, cards with magnetic strips, or cards for transmitting signals, may not function correctly when placed together on the tray with the device. There is a risk of injury and risk of damage to property. When charging mobile devices, make sure there are no objects on the tray together with the device.

⚠ NOTICE

The tray is intended for mobile phones up to a particular size. Forceful inserting of the mobile phone into the tray can damage the tray or the mobile phone. There is a risk of damage to property. Observe the maximum dimensions for mobile phones. Do not force the mobile phone into the tray.

Functional requirements

The following functional requirements apply for the wireless charging tray:

- The smartphone to be charged must be Qi-certified.
- Standby state is switched on.
- The charging function is on.
- The smartphone cannot exceed maximum dimensions of approx. 6.69 x 3.34 x 0.7 in/170 x 85 x 18 mm.
- Protective sleeves and covers must be suitable for wireless charging.
- Place the smartphone to be charged upright in the center of the tray. The smartphone display is facing up.

Activating/deactivating charging

To activate/deactivate charging, go through the menu as follows: Apps menu / "Vehicle" / "System settings" / "Wireless charging tray" / "Wireless charging".

Overview

The wireless charging tray is located in the center console.

Inserting/removing a smartphone



Insert the smartphone upright and in the center, behind the holder, and slide it down to the stop. The smartphone display must point upward.

To remove, pull the smartphone out behind the holder.

- If storage media or electronic cards, e.g., chip cards, cards with magnetic strips, or cards for signal transmission, are located between the smartphone and wireless charging tray.
- Due to protective sleeves and covers that exceed a thickness of 0.07 in/2 mm
- Due to protective sleeves and covers made of unsuitable material, e.g., with magnetic parts.
- Due to add-on parts for the smartphone, e.g., holders.
- By configuring the smartphone settings, e.g., for charging. Follow the instructions given on the Interaction Unit and smartphone, where applicable.

Forgotten warning

General information

A warning may be issued if a Qi-certified smartphone was forgotten in the wireless charging tray when leaving the vehicle.

The Forgotten Warning is displayed on the Interaction Unit.

Enable/Disable Forgotten Warning

To activate/deactivate the Forgotten Warning, go through the menu as follows: Apps menu / "Vehicle" / "System settings" / "Wireless charging tray" / "Mobile phone reminder".

System limits

The charge current may be reduced or charging may be temporarily interrupted in the wireless charging tray in the following situations:

- Due to excessive temperatures on the tray and smartphone.
- If there are objects between the smartphone and wireless charging tray.

Interior camera

Principle

The interior camera can be used to record the vehicle interior.

Prior to the first use of the interior camera, the recording function and, if necessary, data transfer must be activated. To do so, confirm on the Interaction Unit. Additional activation may be required for some system functions.

The interior camera can provide the following functions:

- Interior camera.
Media can be recorded, saved, and played.
- Remote Inside View.
The vehicle interior can be recorded using the MINI app.
- Anti-theft recorder.
If the alarm system is triggered, the vehicle interior is automatically recorded. Recordings can be shown using the MINI app.



Follow applicable legal requirements when using this system.

Data protection

General information

The permissibility of making and evaluating recordings for the interior camera depends on the applicable regulations of the country in which the system is to be used. The user is responsible for the use of the system and compliance with the respective regulations.

The vehicle manufacturer recommends that you verify there are no statutory or regulatory restrictions on using the system in your region or country prior to initial use. In addition, the laws with respect to use of the system should be verified in regular intervals, especially when borders are frequently crossed.

Other users and occupants of the vehicle must be informed about the system. In addition, information about the system is required when handing off the vehicle.

Data transfer and data storage

Whether recording data will be sent or stored depends on the recording function.

The following applies for the interior camera function:

- Data is sent to a mobile device. It must be possible to connect to the vehicle over Wi-Fi.
- Data is saved to the vehicle and assigned to the MINI ID or driver profile.

The following applies for Remote Inside View:

- Data is sent to a mobile device via the MINI app. The MINI app must be linked to the MINI Connected account.
- Data is saved to the MINI app and, after data is sent, to the mobile device.

The following applies for the Anti-Theft Recorder:

- Data is sent to a mobile device via the MINI app. The MINI app must be linked to the MINI Connected account.
- Data is saved to the vehicle and, after data is sent, to the mobile device.

More information on the scope and content of data processing is available online in the MINI Connected privacy notices or service descriptions.

Overview

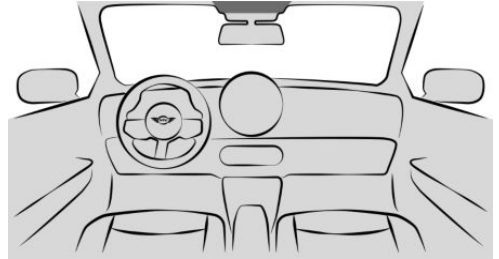

The interior camera is located in the headliner.

Additional information:

Around the headliner, refer to page [33](#).

Functional requirements

The following functional requirements apply for the interior camera function:

- The Privacy Policy has been accepted.
- The camera is activated.

When sending recordings to mobile devices, the following functional requirements apply:

- Data transfer is activated.
- A mobile device is connected to the vehicle via Wi-Fi.

The following functional requirements apply for the Remote Inside View and Anti-Theft Recorder functions:

- The Privacy Policy has been accepted.
- The MINI app is installed on the mobile device.
- The MINI app is linked to the MINI Connected account.
- The vehicle is parked and locked.
- The Anti-Theft Recorder can only be used if vehicle is equipped with an alarm system.

Ensure that the faces of occupants are visible and are not partially or completely covered, for instance by face masks.

Additional information:

Data protection, refer to page 59.

Activating/deactivating interior camera

The interior camera can record and send data when activated, then be deactivated.

1. Go through the menu as follows: Apps menu / "All" / "Interior camera" / "Settings".
2. Select the desired setting.

Interior camera

Recording mode

Recording mode	Function
"Single photo"	Shortly after triggering, a photo will be taken.
"Smile"	When the system detects a smile, a picture will be taken.
"Self-timer (3 sec.)"	After the timer has expired, a photo will be taken.
"Burst mode"	Shortly after triggering, a series of pictures will be taken.

Take picture

A photo can be taken as follows:

1. Go through the menu as follows: Apps menu / "All" / "Interior camera" / "Camera".
2. Select the desired recording mode.
3. Trigger a photo.

Depending on the recording mode selected, photos are taken shortly after being triggered, when a smile is detected, or when the timer elapses.

For burst shots, the series of pictures will be displayed as a preview.

Recording video

Videos can be recorded as follows:

1. Go through the menu as follows: Apps menu / "All" / "Interior camera" / "Camera".
2. Select the recording mode for video recording.
3. Start the video recording.

You can only record video for a certain time.

Displaying and managing recordings

Saved recordings can be played, sent, and deleted in the vehicle.

In some national-market versions, recordings are only shown on the Interaction Unit for up to approx. 2 mph/3 km/h for safety purposes.

1. Go through the menu as follows: Apps menu / "All" / "Interior camera" / "Gallery".
2. Select the desired recording.
3. Select the desired setting.

Scan the QR code shown on the Interaction Unit to send recordings to a mobile device.



The recording is transferred when the pop-up on the mobile device is opened. The mobile device must be connected to the vehicle via WLAN.

camera lens illuminate while the interior camera is active. Depending on the lighting conditions, the infrared light sources may be visible.

Settings

1. To configure the settings for the interior camera, go through the menu as follows: Apps menu / "All" / "Interior camera" / "Settings".
2. Select the desired setting.

Remote Inside View

With Remote Inside View, recordings of the vehicle interior can be played on a mobile device using the MINI app. The vehicle interior can be checked, e.g., for forgotten items.

The function is not suitable for monitoring people or animals left behind.

Anti-theft recorder

The Anti-Theft Recorder automatically records the vehicle interior when the alarm system is triggered. The MINI app sends a notification when a recording is being taken. The recording can be shown on a mobile device.

Up to three media recordings can be saved to the vehicle and synchronized with the MINI app. If the vehicle is reset to factory settings, recordings saved to the vehicle are deleted.

Occupying the seats

The interior camera is also used to detect occupied seats.

The interior camera turns on automatically at regular intervals when all doors are closed. This system analyzes the vehicle interior to detect which seats are occupied. No media recordings are made in the process. Two infrared light sources next to the

Storage compartments

Vehicle features and options

This chapter describes model-specific equipment, systems, and functions that are currently available, or may become available in the future, even if they are not present in the vehicle.

Additional information:

Vehicle equipment, refer to page 8.

Storage compartments

Principle

The vehicle has various options for storing or stowing objects, e.g., the glove compartment or door storage compartments.

Safety information

Warning

When driving, loose items or devices connected to the vehicle with a cable, i.e., mobile phones, may be thrown around the vehicle, e.g., in the event of an accident or when braking or performing evasive maneuvers. There is a risk of injury and risk of damage to property. Secure loose objects or devices that are connected to the vehicle via a cable.

Warning

Open flaps of the storage compartments, e.g., glove compartment or center armrest, protrude into the interior when folded open and may be in the way of an airbag that deploys. In addition, objects in the open storage compartment can be thrown

into the vehicle interior during the trip, for instance, in the event of an accident or when braking or making an evasive maneuver. There is a risk of injury. Always close storage compartments immediately after use.

Warning

Anti-slip pads such as anti-slip mats can damage the dashboard. Attached objects could come loose. There is a risk of injury or risk of damage to property. Do not use anti-slip pads.

Glove compartment

Overview

The glove compartment is located at the bottom of the instrument panel on the front passenger's side.

Opening the glove compartment



Pull the handle on the glove compartment.



Closing the glove compartment

To close the glove compartment, press the glove compartment lid down until it engages.

Locking the glove compartment

The glove compartment can be locked with an integrated key. This prevents access to the glove compartment.

After the glove compartment has been locked, the vehicle key can be given to someone without the integrated key, for example, when the car is being parked by a parking attendant.

Additional information:

Integrated key, refer to page [67](#).

Storage compartments in the doors

Safety information

Warning

Breakable objects such as glass bottles or glasses can break in the event of an accident, braking or an evasive maneuver. Broken glass can be scattered in the car's interior. There is a risk of injury or risk of damage to property. Do not use any breakable objects while driving. Only stow breakable objects in closed storage compartments.

Overview

The storage compartments are located in the doors.

Storage tray in center console

Overview

The storage compartments are located in the center console.

Additional information:

Wireless charging tray, refer to page [257](#).

Opening the storage compartment

To open the storage compartment, proceed as follows:

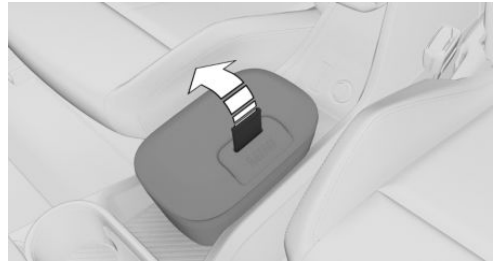

Use the loop on the storage compartment to open the lid, arrow.

Closing the storage compartment

To close the storage compartment, press the lid down until it engages.

Front cup holder

Safety information

Warning

Unsuitable containers in the cup holders may damage the cup holders or be thrown about the car's interior in the event of an accident, an evasive maneuver, or forceful braking. Spilled liquids can distract from the surrounding traffic conditions, lead to an accident and damage vehicle components. Hot drinks can damage the cup

holder or lead to scalding. There is a risk of injury or risk of damage to property. Do not force objects into the cup holder. Make sure that drink containers are secured firmly in the cup holder. Use lightweight, shatterproof, and sealable containers. Clean up spilled liquids immediately. Do not transport hot beverages.

Overview



The center console includes two cup holders.

Rear cup holder

Safety information

Warning

Unsuitable containers in the cup holders may damage the cup holders or be thrown about the car's interior in the event of an accident, an evasive maneuver, or forceful braking. Spilled liquids can distract from the surrounding traffic conditions, lead to an accident and damage vehicle components. Hot drinks can damage the cup holder or lead to scalding. There is a risk of injury or risk of damage to property. Do not force objects into the cup holder. Make sure that drink containers are secured firmly in the cup holder. Use lightweight, shatterproof, and sealable contain-

ers. Clean up spilled liquids immediately. Do not transport hot beverages.

Overview



A cup holder is provided in the rear center console.

Coat hooks

Safety information

Warning

Clothing articles on the coat hooks can obstruct the view while driving. There is a risk of accident. When suspending clothing articles from the coat hooks, ensure that they will not obstruct the driver's view.

Warning

Improper use of the coat hooks can lead to a risk of objects flying about during braking and evasive maneuvers. There is a risk of injury and risk of damage to property. Only hang lightweight objects, for instance clothing articles, from the coat hooks.



Overview

The coat hooks are located on the headliner, above the side windows in the rear.

Cargo area

Vehicle features and options

This chapter describes model-specific equipment, systems, and functions that are currently available, or may become available in the future, even if they are not present in the vehicle.

Additional information:

Vehicle equipment, refer to page 8.

Loading

Principle

When loading the vehicle, items and cargo must be stowed and secured properly. Do not exceed the permissible weights and loads.

Safety information

Warning

High gross vehicle weight can overheat the tires, damage them internally and cause a sudden tire pressure loss. Driving characteristics may be negatively impacted, reducing directional stability, lengthening the braking distances and changing the steering response. There is a risk of accident, injury, or property damage. Pay attention to the permitted load-carrying capacity of the tires and never exceed the permitted gross vehicle weight.

Warning

When driving, loose items or devices connected to the vehicle with a cable, i.e., mobile phones, may be thrown around the vehicle, e.g., in the event of an accident or when braking or performing evasive maneuvers. There is a risk of injury and risk of damage to property. Secure loose objects or devices that are connected to the vehicle via a cable.

Warning

Improperly stowed objects can slip and be thrown into the car's interior, for instance in the event of an accident, braking or an evasive maneuver. Vehicle occupants can be hit and injured. There is a risk of injury and risk of damage to property. Stow and secure objects and cargo properly.

NOTICE

Fluids in the cargo area can cause damage. There is a risk of damage to property. Make sure that no fluids leak in the cargo area.

Steps for determining correct load limit

1. Locate the statement “The combined weight of occupants and cargo should never exceed XXX kg or XXX lbs” on the vehicle's placard.
2. Determine the combined weight of the driver and passengers that will be riding in the vehicle.

3. Subtract the combined weight of the driver and passengers from XXX kg or XXX lbs
4. The resulting figure equals the available amount of cargo and luggage load capacity. For example, if the “XXX” amount equals 1,400 lbs and there will be five 150 lbs passengers in the vehicle, the amount of available cargo and luggage load capacity is 650 lbs (1,400 - 750 (5 x 150) = 650 lbs)
5. Determine the combined weight of luggage and cargo being loaded on the vehicle. That weight may not safely exceed the available cargo and luggage load capacity calculated in Step 4.
6. If the vehicle will be towing a trailer, load from your trailer will be transferred to the vehicle. Consult this manual to determine how this reduces the available cargo and luggage load capacity of the vehicle.

- Cover sharp edges and corners on the cargo.
- Do not stack cargo above the upper edge of the backrests.
- If stowing sufficiently large items in the cargo area, fold down the rear seat backrests completely.
- Small, light-weight cargo: Secure with tensioning/draw straps or with a cargo net.
- Larger, heavy cargo: Secure with cargo straps.
- Stow particularly heavy cargo as far forward as possible, directly behind and below the rear seat backrests. When the rear seat is not occupied, secure each of the outer seat belts in the opposite buckle.

Payload

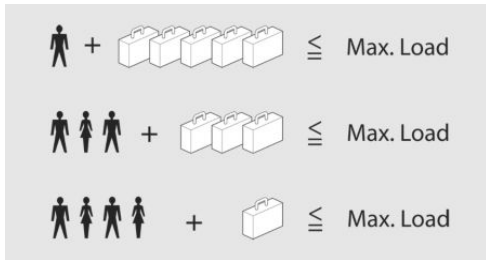

The maximum payload is the sum of the weight of the occupants and the cargo. The greater the weight of the occupants, the less cargo that can be transported.

Stowing and securing cargo

To stow and secure cargo, note the following:

Cargo floor panel

Principle

To stow cargo, a storage compartment is provided under the cargo area floor. The cargo area floor can be folded up and removed.

Safety information

Warning

Improper use of the cargo area floor can lead to a risk of objects flying about during braking and evasive maneuvers, for example. There is a risk of injury and risk of damage to property.

- Do not use the cargo area floor to separate the cargo area and vehicle interior in the sense of a luggage net.
- Only use the cargo area floor in the folded-up position when the rear seat backrests are folded up and locked.

- Fold down the cargo area floor before driving off.
- Always secure cargo against slipping, using straps, belts and lashing eyes, for instance.

NOTICE

The storage space under the cargo floor panel is only suitable for soft objects. Hard objects may result in damage to the vehicle electrical system in the event of an accident. There is a risk of damage to property. Only stow soft objects under the cargo floor panel.

Opening the storage compartment



To open the storage compartment, pull the cargo area floor upward using the loop and fold it open.

Removing the cargo floor panel

The cargo area floor can be removed as follows:

1. Remove the cargo cover as necessary.
2. Grip the cargo area floor by the loop and fold it up.
3. Pull the trunk floor back and up, out of the mounts, then remove.

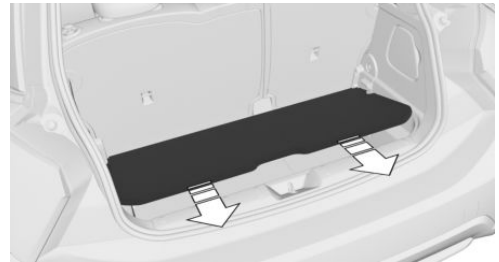

Additional information:

Remove cargo cover, refer to page [272](#).

Inserting the cargo floor panel

Proceed in reverse order to insert the cargo area floor:

1. Insert the trunk floor into the mount from behind.
2. Fold the cargo area floor down.

Cargo area floor positions

Principle

Depending on vehicle equipment, the cargo area floor can be placed in two different positions to adapt the cargo area to the cargo.

Upper position

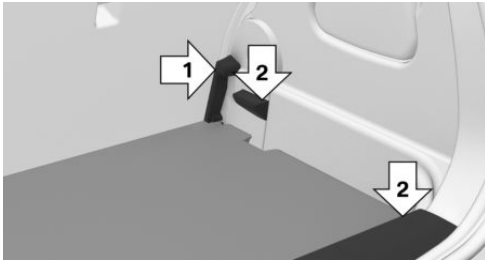

Insert the cargo area floor into the upper position of the holder, arrow 1, then place it on the console and edge of the rear wall, arrow 2.

- With the backrests folded down, a long, flat loading platform is produced.
- There is space under the cargo area floor for additional cargo.

Lower position

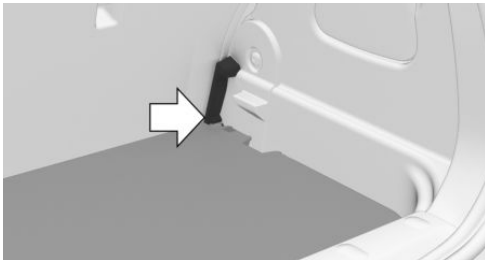

Insert the cargo area floor from above into the lower position of the holder, then fold it down.

- Larger objects can be transported.
- There is space under the cargo area floor for smaller cargo.

Enlarging the cargo area

Principle

The cargo area can be enlarged by folding down the rear seat backrests.

General information

The rear seat backrest is divided at a ratio of 60 to 40.

The rear seat backrests can be folded down from the rear.

Safety information

⚠ Warning

There is a danger of jamming with folding down the rear seat backrests. There is a risk of injury or risk of damage to property. Make sure that the area of movement of the rear seat backrest and the of the head restraint is clear prior to folding down.

⚠ Warning

If a rear seat backrest is not locked, unsecured cargo can be thrown about the car's interior; for instance, in the event of an accident, braking or an evasive maneuver. There is a risk of injury. Make sure that the rear seat backrest is locked after folding it back.

⚠ Warning

The stability of the child restraint system is limited or compromised with incorrect seat setting or improper installation of the child seat. There is a risk of injury or danger to life. Make sure that the child restraint system fits securely against the backrest. If possible, adjust the backrest

tilt for all affected backrests and correctly adjust the seats. Make sure that seats and backrests are securely engaged or locked. If possible and necessary, adjust the height of the head restraints or remove them.

Folding down the rear seat backrest

To fold in the rear seat backrests, proceed as follows:

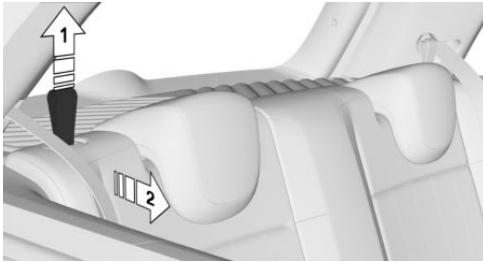

On the rear seat backrest, pull the loop, arrow 1, and fold the rear seat backrest forward, arrow 2.

Folding back the backrest

To fold back the rear seat backrests, proceed as follows:

Fold back the rear seat backrest and push it into the locking mechanism. Make sure that the seat belt is not caught behind the backrest or in between the backrest and the rear seats.

Cargo cover

Principle

The cargo cover separates the cargo area from the seat rows and is used to secure cargo. The cargo cover can be removed.

Safety information

Warning

When driving, loose items or devices connected to the vehicle with a cable, i.e., mobile phones, may be thrown around the vehicle, e.g., in the event of an accident or when braking or performing evasive maneuvers. There is a risk of injury and risk of damage to property. Secure loose objects or devices that are connected to the vehicle via a cable.

Warning

An incorrectly inserted cargo cover can be thrown about the car's interior such as in the event of an accident or a braking or evasive maneuver. There is a risk of injury and risk of damage to property. Make sure the cargo cover is securely engaged in the brackets.

Warning

Body parts can become trapped when the folding cargo cover is operated. There is a risk of injury. When operating the folding cargo cover, make sure that the travel path of the cover is clear.

Removing the cargo cover

The cover can be removed to load bulky luggage.

1. Detach the retaining straps on the tail-gate.
2. Grasp the cover, with both hands on the rear edge, and lift slightly.

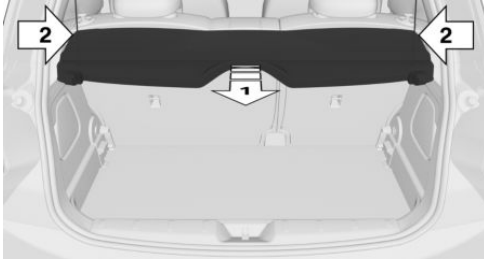

3. Pull the cover backward, arrow 1, out of the mounts, arrow 2.

Inserting the cargo cover

Install the cargo cover in reverse order. Make sure that the cargo cover is positioned correctly in the brackets and that it is engaged.



Things to remember when driving

Vehicle features and options

This chapter describes model-specific equipment, systems, and functions that are currently available, or may become available in the future, even if they are not present in the vehicle.

Additional information:

Vehicle equipment, refer to page 8.

Break-in procedures

General information

Moving parts need to work together smoothly.

The following break-in procedures will help the vehicle achieve a long service life and good efficiency.

During break-in, do not use the Launch Control.

Safety information

Warning

Due to new parts and components, safety and driver assistance systems can react with a delay. There is a risk of accident, injury, or property damage. After installing new parts or with a new vehicle, drive conservatively and intervene early if necessary. Observe the break-in procedures of the respective parts and components.

Engine, transmission, and axle drive

Up to 1,200 miles/2,000 km

Do not exceed the maximum engine and road speed:

- For gasoline engine 4,500 rpm and 100 mph/160 km/h.

Avoid full throttle or kickdown under all circumstances.

From 1,200 miles/2,000 km

The engine and vehicle speed can gradually be increased.

Tires

Tire traction is not optimal due to manufacturing circumstances when tires are brand new.

Drive conservatively for the first 200 miles/300 km.

Brake system

Brake disks and brake pads must be broken in to avoid the conditions that can lead to brake noise. Drive carefully for the first approx. 300 miles/500 km.

Following part replacement

Observe the break-in procedures again if components mentioned above are replaced.

General driving notes

Closing the tailgate

Safety information

Warning

An open tailgate protrudes from the vehicle and can endanger occupants and other road users or damage the vehicle in the event of an accident, braking or evasive maneuvers. In addition, exhaust gas or water may enter the vehicle interior. There is a risk of injury or risk of damage to property. Do not drive with the tailgate open.

Driving with the tailgate open

If the vehicle still needs to be driven with the tailgate open:

- Close all windows and the glass sunroof.
- Greatly increase the blower output.
- Drive moderately.
- Secure the tailgate, e.g., with a tensioning belt.

Hot exhaust system

Warning

High temperatures can occur underneath the body, for instance caused by the exhaust system, while driving. Contact with the exhaust system can cause burns. There is a risk of injury. Do not touch the exhaust system, including the exhaust pipe, when hot.

Warning

If combustible materials such as leaves or grass come in contact with hot parts of the exhaust system, these materials can ignite. There is a risk of fire and an injury hazard. Do not remove the heat shields installed and never apply undercoating to them. Make sure that no combustible materials can come in contact with hot vehicle parts while driving, in Neutral or during parking.

Exhaust gas particulate filter

Principle

The exhaust gas particulate filter collects soot particles. The soot particles are burned at high temperatures to clean the exhaust gas particulate filter as necessary.

General information

Depending on vehicle equipment and national-market version, the vehicle is equipped with an exhaust particulate filter. For more information on the exhaust particulate filter, contact an authorized service center or another qualified service center or repair shop.

The following may occur when cleaning for several minutes:

- The engine may not run as smoothly for a short time.
- A somewhat higher RPM is necessary to reach usual power development.
- Fuel consumption may be higher. The higher fuel consumption is included as mean value in the display for the current consumption.

- Exhaust system may smoke slightly, even after the engine is switched off.
- Noises such as those caused by the radiator fan running, even several minutes after the engine is switched off.

Overrun of the radiator fan for several minutes is normal even after short trips.

Cleaning the exhaust gas particulate filter while driving

The self-cleaning function of the diesel particulate filter takes place automatically. There are no other measures, e.g., an adjustment of the driving style.

Vehicle laminated glass

The vehicle laminated glass provides complete protection against the harmful effects of ultraviolet radiation on the skin.

Mobile communications in the vehicle

⚠ Warning

Vehicle electronics and mobile communication devices can influence one another. There is radiation due to the transmission operations of mobile communication devices. There is a risk of injury or risk of damage to property. If possible, only use mobile communication devices, e.g., mobile phones, when connected directly to an external antenna or Personal eSIM in order to prevent mutual interference and to deflect radiation from the vehicle interior.

Aquaplaning

On wet or slushy roads, a wedge of water can form between the tires and road surface.

This phenomenon is referred to as aquaplaning. It is characterized by a partial or

complete loss of contact between the tires and the road surface, ultimately undermining your ability to steer and brake the vehicle.

Driving through water

General information

When driving through water, note the following:

- Only drive through when the engine is running.
- Engage selector lever position S or L, depending on vehicle equipment, to prevent the engine from shutting off.
- The engine also does not switch off in selector lever position R.
- Drive through calm water only.
- Drive through water only up to a maximum height of 9.8 inches/25 cm.
- Drive through water at walking speed, max. 3 mph/5 km/h.

Additional information:

Auto Start/Stop function, refer to page [115](#).

Safety information

⚠ NOTICE

When driving too quickly through deep water, the water can penetrate the engine compartment, the electrical system, or the transmission. There is a risk of damage to property. When driving through water, do not exceed the maximum indicated water level and the maximum speed for driving through water.

Braking safely

General information

The vehicle is equipped with an Antilock Braking System as a standard feature.

Perform full braking when appropriate. To achieve the best possible braking assistance, do not reduce the pressure on the brake pedal during full braking.

Steering is still responsive. You can still avoid any obstacles with a minimum of steering movement.

Sounds from the hydraulic circuits indicate that the Antilock Braking System is regulating.

Objects in the travel path of the pedals

Warning

Objects in the driver's footwell can limit the pedal travel or block a depressed pedal. There is a risk of accident. Stow objects in the vehicle such that they are secured and cannot enter into the driver's footwell. Use floor mats that are suitable for the vehicle and can be safely attached to the floor. Do not use loose floor mats and do not layer several floor mats. Make sure that there is sufficient clearance for the pedals. Ensure that the floor mats are securely fastened again after they were removed, for instance for cleaning.

Pedal feel when driving off

After turning on drive-ready state from idle state, the pedal may feel unusual, e.g., the pedal travel path may feel short or long. After the brake pedal has been fully released, the pedal will feel as usual again.

Driving in wet conditions

In case of wet roads, exposure to road salt or in heavy rain, gently depress the brake pedal every few kilometers. Ensure that this action does not endanger other road users.

The heat generated while braking dries brake disks and brake pads and protects them against corrosion.

In this way the brake power will be available when you need it.

Hills

General information

Drive long or steep downhill gradients in the gear that requires least braking effort. Otherwise, the brake system may overheat and reduce braking effect.

You can increase the engine braking effect by downshifting, going all the way to first gear, if needed.

Safety information

Warning

Light but constant pressure on the brake pedal can lead to high temperatures, brake wear, and even failure of the brake system. There is a risk of accident, injury, or property damage. Avoid placing excessive stress on the brake system.

Warning

In Neutral or with drive-ready state switched off, safety functions, for instance engine braking effect, braking assistance and steering assistance, may be restricted or not available. There is a risk of accident, injury, or property damage. Do not attempt to drive in Neutral or with drive-ready state switched off.

Brake disk corrosion

Corrosion on the brake disks and contamination on the brake pads are increased by the following circumstances:

- Low mileage.
- Extended stationary periods.
- Low load.
- Aggressive, acidic, or alkaline cleaning agents.

Corrosion buildup on the brake disks will cause a pulsating effect on the brakes when braking slowly - generally this cannot be corrected.

Condensation water under the parked vehicle

When using the automatic climate control, condensation water develops and collects underneath the vehicle.

Roof bars

Principle

Roof bars are devices that are mounted on the vehicle to facilitate the transport of luggage. When driving with a roof bar, various specifications, e.g., correct load, must be followed.

General information

The roof bar can only be installed if the vehicle has a roof rail.

Roof racks are available as optional accessories.

Safety information

Warning

When driving with a roof load, e.g., roof bars, the vehicle's center of gravity is higher. This increases the risk of the vehicle tipping in critical driving situations. There is a risk of accident, injury, or property damage. Drive with roof load only with activated Dynamic Stability Control.

Installation

Follow the installation instructions for roof bars when installing.

Be sure that adequate clearance is maintained for tilting and opening the glass sunroof.

Loading

Because roof racks raise the vehicle's center of gravity when loaded, they have a significant effect on vehicle handling and steering.

When loading and driving, note the following:

- Do not exceed the permissible roof load, axle load, and gross vehicle weight.
- Distribute the roof load evenly.
- The roof load should not extend past the vehicle sides.
- Always place the heaviest pieces on the bottom.
- Secure roof luggage firmly, for instance using tie-down straps.
- Do not let objects project into the swiveling range of the tailgate.
- Drive carefully. Do not drive off or brake suddenly or take corners at speed.

Driving on racetracks

Warning

The vehicle is not designed for use in M Sport or motorsport-like competition. There is a risk of accident, injury, or property damage. Do not use the vehicle for M Sport or motorsport-like competitions.

Higher mechanical and thermal loads during racetrack operation lead to increased wear. Use of the vehicle in M Sport or motor sport type competition is an improper use of the vehicle and may affect your warranty coverage. Please consult the New Vehicle Limited Warranty Booklet for further information on warranty matters.

The vehicle manufacturer recommends using special sport tires, e.g., high-performance tires. Sport tires are designed for the specific requirements of driving on the racetrack. For more information on sport tires, contact an authorized service center or another qualified service center or repair shop.

Before and after driving on a racetrack, have the vehicle checked by an authorized service center or another qualified service center or repair shop.

Saving fuel

Vehicle features and options

This chapter describes model-specific equipment, systems, and functions that are currently available, or may become available in the future, even if they are not present in the vehicle.

Additional information:

Vehicle equipment, refer to page 8.

Reducing fuel consumption

Principle

The vehicle contains advanced technologies for the reduction of consumption and emission values.

There are some actions you can take to change your fuel consumption and environmental impact:

- Remove unnecessary cargo from the vehicle.
- Remove add-on parts, e.g., a rear carrier, after use.
- Close the windows and glass sunroof while driving.
- Check the tire pressure regularly and increase it as necessary.
- Switch off the engine if the vehicle is to remain stationary for a longer period.
- Practice anticipatory driving and let the vehicle coast more often.
- Deactivate functions that are not required, e.g., rear window heating.
- Have the vehicle serviced regularly.

Coasting

Principle

The drive system allows the vehicle to coast freely with minimal deceleration in selector lever position D. This driving condition is referred to as coasting. This reduces fuel consumption.

General information

An anticipatory driving style helps the driver use the coasting function often and enhances the consumption-reducing effect of coasting.

Coasting is automatically adapted to the respective driving situation.

Exemplary driving situations

If you can travel a certain distance without any foreseeable need to brake, it is beneficial to coast.

The following example driving situations may be suitable for coasting:

- Coasting on a straight downhill gradient with no obstacles.
- Coasting on a distance without obstacles.

Avoid late or strong braking.

Functional requirements

Note the following functional requirements when coasting:

- Selector lever position D is engaged.
- The brake has not been applied.
- The accelerator pedal has not been pressed.
- The engine and transmission are at operating temperature.

The function is available in the speed range from approx. 16 mph/25 km/h to 100 mph/160 km/h.

Operation via shift paddles

Principle

Depending on the vehicle's equipment, the Coasting mode can be influenced with the shift paddles.

Activating/deactivating coasting via shift paddles

To activate coasting, operate the right shift paddle.

To deactivate, actuate the left shift paddle.

System limits

In the following situations, coasting cannot be used at all or only to a limited extent:

- When Active Cruise Control is on.
- Sensors are defective, dirty, or covered.
- Driving in the dynamic limit range and on steep uphill/downhill grades.
- If the battery charge level is too low temporarily, or if the electrical system requires too much power.

Green Mode

Principle

Green Mode helps promote an efficient driving style.

In addition, the efficiency trainer displays situation dependent notes to assist with an efficient driving style.

The extended range achieved can be displayed as a bonus range on the Interaction Unit.

Overview

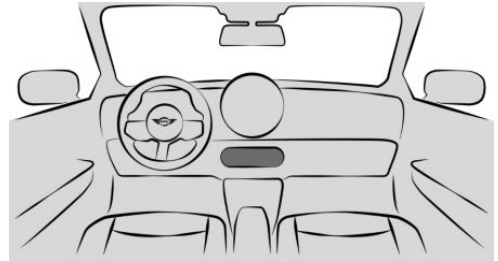



The MINI Modes switch is located on the switch cluster and labeled EXPERIENCE.

Configuring Green Mode



General information

To configure Green Mode, proceed as follows:

1.  On the switch cluster, select Green Mode using the MINI Modes switch.
2.  Tap the Settings icon on the Interaction Unit.
3. Select the desired setting.

Resetting the settings

To reset the settings, proceed as follows:

1.  On the switch cluster, select Green Mode using the MINI Modes switch.
2.  Tap the Settings icon on the Interaction Unit.
3. "Reset settings".

Efficiency trainer

Principle

The Efficiency Coach supports an anticipatory and comfort-oriented driving style. To do so, map and sensor data is used to analyze the current driving situation, e.g., preceding vehicles. Based on this information, the driver receives notices for an efficient driving style early on.

General information

The system has different displays to support the driver with an efficient driving style.

Functional requirements

Note the following functional requirements when using the Efficiency Coach:

- Selector lever position D is engaged.
- It may be necessary to activate Experience View in the MINI Modes settings.

Display

General information

When Green Mode is enabled, the view on the Interaction Unit switches to the specific Green Mode view.

In addition, full-screen view and minimalist view contain visualizations for the Efficiency Coach.

Some system information can also be displayed in the Head-up display.



The efficient range of the power gauge is colored green. Additionally, the bonus range will be displayed.

The bonus range and animal symbols for efficient driving styles are displayed, depending on the driving situation.

If the power gauge moves within the green range, the current driving style is efficient. If the driving style is inefficient, the display changes to red and the animal symbol changes.

Additional information:

Power gauge, refer to page 140.

Bonus range

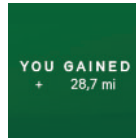

A modified driving style helps you extend your driving range.

The extended range is displayed as a bonus range on the Interaction Unit.

The increase/decrease in the bonus range is symbolized by the arrow to the left of the bonus range, providing an indication of the current driving style.

The intervals for resetting the bonus range depend on the settings of the trip data.

Display in case of inefficient driving style



An arrow appears on the Interaction Unit when the vehicle is driven beyond its efficient range.

For instance, this is displayed in the following situations:

- Excessive acceleration.
- Excessive speed.

In addition, information on the reason for the delay can be displayed.

System limits

This function may not be available in the following situations, for example:

- When Active Cruise Control is on.
- When the transmission Sport program is activated.

Refueling

Vehicle features and options

This chapter describes model-specific equipment, systems, and functions that are currently available, or may become available in the future, even if they are not present in the vehicle.

Additional information:

Vehicle equipment, refer to page [8](#).

Follow the following when refueling

General information

Follow the fuel recommendation prior to refueling.

When refueling, hook the fuel pump nozzle completely into the filler pipe. Lifting the pump nozzle while refilling causes the diesel exhaust fluid to shut off prematurely and reduces fuel vapor recirculation.

The fuel tank is full when the fuel pump nozzle clicks off the first time.

Make sure that the fuel cap is closed properly after refueling, otherwise the emissions warning light may illuminate.

Follow safety regulations posted at the filling station.

Additional information:

Fuel quality, refer to page [318](#).

Safety information

NOTICE

With a range below 30 miles/50 km, the engine may no longer have sufficient fuel. Engine functions are not ensured anymore. There is a risk of damage to property. Refuel promptly.

NOTICE

Fuels are toxic and aggressive. Overfilling of the fuel tank can damage the fuel system. Painted surfaces may be damaged by contact with fuel. Escaping fuel can harm the environment. There is a risk of damage to property. Avoid overfilling.

Fuel filler cap

General information

If the fuel filler cap is not fitted correctly, the emissions indicator light illuminates on the instrument cluster.

Additional information:

Indicator/warning lights, refer to page [134](#).

Safety information

Warning

The fuel filler cap's retaining strap can become pinched and crushed when the cap is closed. It will then not be possible to close the fuel filler cap correctly. Fuel or fuel vapors can escape. There is a risk of injury or risk of damage to property. Make sure that the retaining strap does not become

pinched or crushed when closing the fuel filler cap.

Opening

1. To open the fuel filler flap, press on the rear edge, arrow. The fuel filler flap opens.



2. Turn the fuel filler cap counterclockwise.

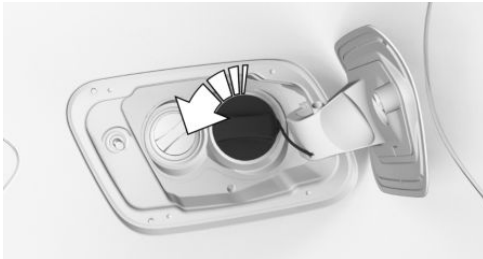

3. Place the fuel filler cap in the mount on the fuel filler flap.

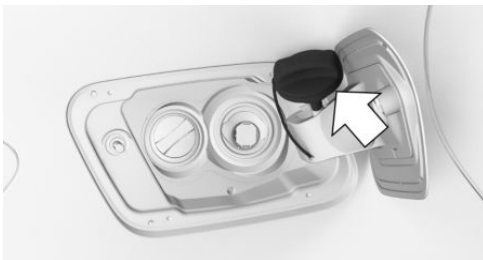

Closing

To open the fuel filler cap, proceed as follows:

1. Fit the fuel filler cap and turn it clockwise until it clicks audibly.
2. Press the fuel filler flap in until it engages.

Emergency unlocking

It may be necessary in certain situations to unlock the fuel filler flap manually, for instance with an electrical malfunction.

Have the fuel filler flap unlocked by an authorized service center or another qualified service center or repair shop.

Wheels and tires

Vehicle features and options

This chapter describes model-specific equipment, systems, and functions that are currently available, or may become available in the future, even if they are not present in the vehicle.

Additional information:

Vehicle equipment, refer to page 8.

Tire pressure

General information

The tire condition and tire pressure influence the following:

- Tire service life.
- Driving safety.
- Driving comfort.
- Fuel consumption.

Safety information

Warning

A tire with too little or no tire inflation pressure may heat up significantly and sustain damage. This will have a negative impact on aspects of handling such as steering and braking response. There is a risk of accident, injury, or property damage. Regularly check the tire inflation pressure, and correct it as needed, for instance twice a month and before a long trip.

Tire pressure specifications

In the tire pressure table

The tire pressure table, refer to page 286, contains all tire inflation pressure specifications for given tire sizes at ambient temperature. The tire inflation pressure specifications apply to the tire sizes approved by the vehicle manufacturer for the corresponding vehicle types.

To identify the correct tire inflation pressure, please note the following:

- Tire sizes of the vehicle.
- Maximum speed for driving.

On the Interaction Unit

Current tire pressures and nominal tire pressures for fitted tires can be displayed on the Interaction Unit.

To ensure that they are displayed correctly, the tire sizes must be stored in the system and must have been set for the mounted tires.

The current tire inflation pressure value is located on each tire.

The reference tire pressure is shown at the bottom of the Interaction Unit.

Checking the tire pressure

General information

The tires heat up while driving. The tire pressure increases with the tire temperature.

Check the tire pressure regularly and correct as necessary.

Tires have a natural, consistent tire pressure loss. The displays of inflation devices may under-read by up to 0.1 bar/2 psi.

Functional requirements

Only check the tire pressure when the tires are cold, i.e.:

- Vehicle has not exceeded a distance traveled of max. 1.25 miles/2 km.
- If the vehicle has not moved again for at least two hours after a trip.

Checking via tire pressure specifications in tire pressure table

To check the tire pressure using the tire pressure specifications in the tire pressure table, proceed as follows:

1. Determine the nominal tire pressure for your tires using the information on the door pillar in the driver's door.
2. Check the tire inflation pressure in all four tires, using a pressure gage, for example.
3. Correct the tire inflation pressure if the actual tire inflation pressure deviates from the intended tire inflation pressure.
4. Make sure that all valve caps are screwed onto the tire valves.

The tire pressures specified in the tire pressure table only correspond to cold tires or tires at ambient temperature.

If vehicle is equipped with an emergency wheel: Check the tire pressure of the emergency wheel in the cargo area regularly and correct as necessary.

Tire inflation pressures up to 100 mph/160 km/h

For speeds of up to 100 mph/160 km/h and for optimum driving comfort, follow the tire inflation pressure specifications in the tire pressure table and adjust as necessary.

Checking tire pressure specifications on Interaction Unit

To check the tire pressure using the tire pressure information on the Interaction Unit, proceed as follows:

1. Go through the menu as follows: Apps menu / "Vehicle" / "Vehicle status" / "Tire Pressure Monitor".
2. Check whether the current tire inflation pressure levels deviate from the intended tire pressure value.
3. Correct the tire inflation pressure if the actual tire inflation pressure deviates from the intended tire inflation pressure.

The Interaction Unit may not be able to display current tire pressures when the vehicle is stationary. The tire pressure will update after a short drive.

After correcting the tire pressure

If your vehicle is equipped with a Tire Pressure Monitor, the corrected tire pressures are applied automatically. Make sure that the tire settings are correct. When using tires not listed in the tire inflation pressure specifications on the Interaction Unit, reset the Tire Pressure Monitor.

If your vehicle is equipped with the Flat Tire Monitor, reinitialize it.



Do not exceed a speed of 100 mph/160 km/h.

The tire inflation pressure specifications can also be found on the tire pressure label on the driver's door pillar.

Tire pressure values up to 100 mph/160 km/h

3-door: Cooper S

The tire inflation pressure specifications in the tire pressure table correspond to cold tires and full load.

Tire size	Front wheel Tire pressure specifications in bar/PSI	Rear wheel Tire pressure specifications in bar/PSI
215/45 R 17 91 H XL A/S	2.5 / 36	2.2 / 32
215/45 R 17 91 Y XL		
215/45 R 17 91 H XL M+S		
215/40 R 18 89 Y XL	2.7 / 39	2.2 / 32
195/50 R 17 89 H XL M+S		
205/45 R 17 88 W XL	2.8 / 41	2.3 / 33

Tire pressures over 100 mph/160 km/h

Warning

When driving at speeds greater than 100 mph/160 km/h, incorrect tire pressures can negatively affect vehicle handling, e.g., safety or comfort while driving. The tires can become damaged, which

may cause an accident. There is a risk of accident, injury, or property damage. To drive at maximum speeds, note the specified tire pressure for driving above 100 mph/160 km/h in the tire inflation pressure table, and adjust as necessary.

Tire pressure values over 100 mph/160 km/h

3-door: Cooper S

The tire inflation pressure specifications in the tire pressure table correspond to cold tires and full load.

Tire size	Front wheel Tire pressure specifications in bar/PSI	Rear wheel Tire pressure specifications in bar/PSI
215/45 R 17 91 H XL A/S	2.8 / 41	2.4 / 35
215/45 R 17 91 Y XL		
215/45 R 17 91 H XL M+S		
215/40 R 18 89 Y XL	3.0 / 44	2.6 / 38
195/50 R 17 89 H XL M+S		
205/45 R 17 88 W XL	3.3 / 48	2.9 / 42

Tire marking

Tire size

245/45 R 18 96 Y

245: nominal width in mm

45: cross-sectional relationship in %

R: radial tire code

18: rim diameter in inches

96: load index

Y: speed code letter

ZR tires: reinforced radial tire for speeds exceeding 150 mph/240 km/h

Maximum tire load

Maximum tire load is the maximum permissible weight for which the tire is approved.

Locate the maximum tire load on the tire sidewall and the Gross Axle Weight Rating – GAWR – on the certification label on the driver door B-pillar. Divide the tire load by 1.1. It must be greater than one-half of the vehicle's Gross Axle Weight Rating –

GAWR. Note, front vs. rear GAWR and tire loads, respectively.

Speed letter

Designation	Maximum speed
Q	up to 100 mph/160 km/h
R	up to 106 mph/170 km/h
S	up to 112 mph/180 km/h
T	up to 118 mph/190 km/h
H	up to 131 mph/210 km/h
V	up to 150 mph/240 km/h
W	up to 167 mph/270 km/h
Y	up to 186 mph/300 km/h
(Y)	above 186 mph/300 km/h

Tire Identification Number

DOT code: DOT xxxx xxx 0124

xxxx: manufacturer code for the tire brand

xxx: tire size and tire design

0124; tire age

Tires with DOT codes meet the guidelines of the U.S. Department of Transportation.

Tire age

Recommendation

Regardless of the tire tread depth, replace tires at least every 6 years.

Production date

You can find the tire production date on the tire sidewall.

Designation	Production date
DOT ... 0124	1st week of 2024

Uniform Tire Quality Grading

Quality grades can be found where applicable on the tire sidewall between tread shoulder and maximum section width.

E.g.: Treadwear 200; Traction AA; Temperature A

DOT Quality Grades

Treadwear

Traction AA A B C

Temperature A B C

All passenger vehicle tires must conform to Federal Safety Requirements in addition to these grades.

Treadwear

The treadwear grade is a comparative rating based on the wear rate of the tire when tested under controlled conditions on a specified government test course. E.g., a tire graded 150 would wear one and one-half, 1 g, times as well on the government course as a tire graded 100. The relative performance of tires depends upon the actual conditions of their use, however, and

may depart significantly from the norm due to variations in driving habits, service practices and differences in road characteristics and climate.

Traction

The traction grades, from highest to lowest, are AA, A, B, and C.

Those grades represent the tire's ability to stop on wet pavement as measured under controlled conditions on specified government test surfaces of asphalt and concrete. A tire marked C may have poor traction performance.

The traction grade assigned to this tire is based on straight-ahead braking traction tests, and does not include acceleration, cornering, hydroplaning, or peak traction characteristics.

Temperature

The temperature grades are A, the highest, B, and C, representing the tire's resistance to the generation of heat and its ability to dissipate heat when tested under controlled conditions on a specified indoor laboratory test wheel. Sustained high temperature can cause the material of the tire to degenerate and reduce tire life, and excessive temperature can lead to sudden tire failure. The grade C corresponds to a level of performance which all passenger car tires must meet under the Federal Motor Vehicle Safety Standard No. 109. Grades Band A represent higher levels of performance on the laboratory test wheel than the minimum required by law.

Warning

The temperature grade for this tire is established for a tire that is properly inflated and not overloaded. Excessive speed, underinflation, or excessive loading, either

separately or in combination, can cause heat buildup and possible tire failure.

M+S

Winter tires, as well as all-season tires with better winter performance than summer tires, can be identified by the M+S marking on the tire side wall.

Tire tread depth

Safety information

Warning

If the tire tread depth is too low, driving safety may be impaired in critical situations such as aquaplaning or slush on the road. There is a risk of accident, injury, or property damage. The tire tread depth may not fall below 0.12 in/3 mm for summer tires and 0.16 in/4 mm for winter and all-season tires, or observe the statutory regulations on minimum tread depth.

Minimum tread depth

You can check the minimum tread depth on your tires using the wear indicators.



The tire manufacturer's wear indicators are distributed over the tire circumference. These indicators have a height of min.

0.06 in/1.6 mm and serve as an indicator for tire tread wear.

The positions of the wear indicators are marked on the tire sidewall with TWI, Tread Wear Indicator.

Tire damage

General information

Check your tires regularly for damage, foreign objects lodged in the tread, and tread wear.

The following abnormalities may indicate tire damage or a malfunction on the vehicle:

- Unusual vibrations.
- Unusual tire or running noises.
- Unusual vehicle handling such as a strong tendency to pull to the left or right.
- Uneven wear pattern, e.g., increased wear near tire shoulder.

Tire damage can be caused by situations such as the following:

- Driving over curbs.
- Road damage.
- Tire pressure too low.
- Vehicle overloading.
- Incorrect tire storage.

Safety information

Warning

Damaged tires can lose tire inflation pressure, which can lead to loss of vehicle control. There is a risk of accident, injury, or property damage. If tire damage is suspected while driving, immediately reduce speed and stop. Have wheels and tires checked. To do so, drive carefully to

an authorized service center or another qualified service center or repair shop. Have the vehicle towed or transported as needed. Do not repair damaged tires, but have them replaced.

Warning

The wheels, tires and chassis components can become damaged when driving over curbs, road damage, or other obstacles. Larger wheels have a smaller tire cross-section. The smaller the tire cross-section, the higher the risk of tire damage. There is a risk of accident, injury, or property damage. If possible, avoid driving over curbs, road damage or other obstacles, or drive over them slowly and carefully.

Exchanging wheels and tires

Mounting and wheel balancing

Have the wheel mounted and balanced by an authorized service center or another qualified service center or repair shop.

Suitable wheels and tires

General information

Only certain wheel/tire combinations are suitable depending on vehicle and equipment. The vehicle manufacturer determines wheel/tire combinations on the basis of the following criteria:

- Tire size, e.g., tire width, aspect ratio.
- Wheel size, e.g., rim diameter, offset.

For more information on wheel/tire combinations and special equipment, contact an authorized service center or another qualified service center or repair shop.

Safety information

Warning

Wheels and tires that are not suitable for the vehicle can damage parts of the vehicle. There is a risk of accident, injury, or property damage. The vehicle manufacturer recommends that you use only wheels and tires that have been recommended for the vehicle type.

Warning

Wheel/tire combinations that are not suitable for the vehicle can affect vehicle handling and a number of system functions, e.g., the Antilock Braking System or Dynamic Stability Control. There is a risk of accident, injury, or property damage. The manufacturer of the vehicle recommends that you use wheels and tires that have been recommended by the vehicle manufacturer for the vehicle type. Following tire damage, have the original wheel/tire combination remounted on the vehicle as soon as possible.

Recommended tire brands



Tire types are developed for each vehicle and optimized specifically for the individual requirements of that vehicle, e.g.:

- Handling.
- Comfort.
- Noise characteristics.

Specially developed tires are marked with a star on the tire sidewall. After replacing wheels and tires, the vehicle manufacturer recommends using star-marked tires again. The vehicle manufacturer recommends that you use tires of the same make and tread design.

New tires

Tire traction is not optimal due to manufacturing circumstances when tires are brand new.

Drive conservatively for the first 200 miles/300 km.

Retreaded tires

Warning

Retreaded tires can have different tire casing structures. With advanced age the service life can be limited. There is a risk of accident, injury, or property damage. The manufacturer of the vehicle does not recommend the use of retreaded tires.

Maximum speed

Safety information

Warning

If the maximum permissible speed of your mounted tires is exceeded, the tires may be damaged. There is a risk of accident, injury, or property damage. Do not exceed the maximum permissible speed of the tires.

Maximum speed of winter tires

If the maximum speed of the vehicle is higher than the permissible speed of the winter tires, the maximum permissible speed must be indicated with a sign placed in the field of vision. The info label is available from an authorized service center or another qualified service center or repair shop.

Winter tires



Winter tires are recommended for operating on winter roads.

Winter tires can be identified by the mountain/snowflake icon and the letters M+S on the tire sidewall.

So-called all-season tires with the M+S designation but no mountain/snowflake icon perform better in winter than summer tires. As a rule, all-season tires do not perform the same as winter tires.

Changing runflat tires

When changing from runflat tires to standard tires, it must be ensured that the vehicle contains an emergency wheel or tire mobility kit. For more information, contact an authorized service center or another qualified service center or repair shop.

Wheel change between axles

Different tread wear patterns can occur on the front and rear axles depending on individual driving conditions. The tires can

be rotated in pairs between the axles to achieve even abrasion. For more information, contact an authorized service center or another qualified service center or repair shop. After changing a wheel, check the tire pressure and correct as necessary.

Storing tires

Do not exceed the maximum tire pressure specified on the tire sidewall, also when storing tires.

When storing tires, note the following:

- Store wheels and tires in a cool, dry and dark place.
- Protect tires from coming into contact with oil, grease, and solvents.
- Do not leave the tires in plastic bags.
- Remove dirt from wheels or tires.

Repairing a flat tire

If you get a flat tire, take the following safety precautions:

- Park the vehicle on solid and non-slip ground at a safe distance from road traffic.
- Switch on the hazard warning lights.
- Engage the parking brake.
- Turn the steering wheel until the front wheels are in the straight-ahead position and engage the steering wheel lock.
- As soon as permitted by the traffic flow, have all vehicle occupants get out and make sure that they remain outside the hazardous area such as behind a guard-rail.
- If necessary, set up the hazard triangle or hazard warning lights at a suitable distance.

Repair the flat tire, e.g., using a tire repair set or by changing the wheel.

Runflat tires

Principle

Runflat tires permit continued driving under limited conditions even in the event of a complete tire pressure loss.

General information

The wheels consist of tires that are self-supporting to a limited degree and may also include special rims.

The reinforcement of the sidewall allows the tire to remain drivable to a limited degree in the event of a tire pressure loss.

Follow the instructions for continued driving with a flat tire.

Safety information

Warning

The vehicle handles differently when a runflat tire has insufficient or no tire pressure; for instance, reduced directional stability when braking, braking distances are longer and the self-steering properties will change. There is a risk of accident, injury, or property damage. Drive moderately and do not exceed a speed of 50 mph/80 km/h.

Warning

Vibrations or loud noises while driving can indicate the final failure of a tire. Tire components may come loose. There is a risk of accident, injury, or property damage. Reduce your speed and stop. Do not continue driving. Contact an authorized service center or another qualified service center or repair shop.

Identification



Runflat tires are labeled with a circular icon containing the letters RSC marked on the tire sidewall.

Tire repair set

Principle

The tire repair set is used to temporarily seal minor tire damage so that it is possible to continue driving.

The filled in tire sealant closes the damage from the inside when it hardens.

The compressor can be used to check the tire inflation pressure.

The tire repair set may be insufficient if the tire damage measures more than approx. 0.16 in/4 mm.

General information

- Follow the instructions for using the tire repair set, which are provided on the compressor and sealant bottle.
- Do not remove foreign objects that have penetrated the tire. Remove foreign objects only when they are visibly protruding from the tire.

Overview

Storage

Depending on vehicle equipment, the tire repair set is stored as follows:

- In the cargo area under the cargo floor panel.
- In the cargo area on the left or right side.
- In the cargo area behind a side trim panel.

Sealant bottle and filler hose

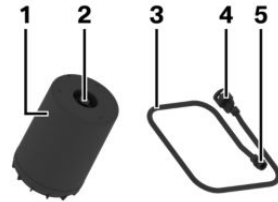

- 1 Sealant bottle
- 2 Sealant bottle outlet
- 3 Filler hose
- 4 Sealant bottle connection
- 5 Wheel valve connection

Compressor

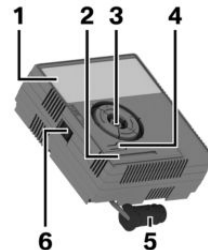

- 1 Compressor
- 2 Tire pressure display

- 3 Sealant bottle mount
- 4 Pressure reducing valve button
- 5 Connector for socket
- 6 Power switch

Safety precautions

When using the tire repair set, take the following safety precautions:

- Park the vehicle as far away as possible from passing traffic and on solid ground.
- Switch on the hazard warning lights.
- Engage the parking brake.
- Turn the steering wheel until the front wheels are in the straight-ahead position and engage the steering wheel lock.
- As soon as permitted by the traffic flow, have all vehicle occupants get out and make sure that they remain outside the hazardous area such as behind a guard-rail.
- If necessary, set up the hazard triangle or hazard warning lights at a suitable distance.
- Remove the warning label for the maximum permissible speed from the sealant bottle and attach it in the visible area in the vehicle interior.

Preparing the tire repair set

1. To prepare the tire repair set, place the sealant bottle into the holder on the compressor housing.



2. Turn the sealant bottle clockwise by 90° to the stop.

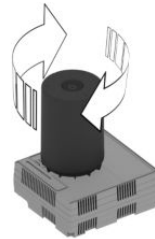

3. Connect the filler hose to the outlet of the sealant bottle and turn clockwise by 90° to the stop.



- Unscrew the valve cap from the wheel and screw the connecting piece of the filler hose onto the valve.

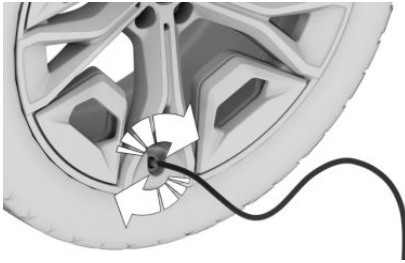

- With the compressor switched off, insert the connector into the power socket in the vehicle interior.

Filling the tire with sealing compound

Safety information

DANGER

If the exhaust pipe is blocked or ventilation is insufficient, harmful exhaust gases can penetrate the vehicle. The exhaust gases contain pollutants which are colorless and odorless. In enclosed areas, exhaust gases can also accumulate outside of the vehicle. There is a danger to life. Keep the exhaust pipe free and ensure sufficient ventilation.

NOTICE

The compressor can overheat during extended operation. There is a risk of damage to property. Do not run the compressor for more than 10 minutes.

Filling the tire with sealing compound

To fill in tire sealant, let the compressor run for max. 10 minutes until a tire pressure of 2.5 bar/36 psi is reached.

- With standby state or drive-ready state switched on, switch on the compressor. When adding sealant, the Tire Pressure Monitor may briefly rise up to approx. 6 bar/87 psi before it shows the actual tire pressure again. Do not turn off the compressor at this stage.
- Switch off the compressor when you reach a tire pressure of 2.5 bar/36 psi.

Checking the tire pressure

To check the tire pressure, read the tire pressure gauge on the compressor. The tire pressure must be at least 2.5 bar/36 psi.

Tire pressure too high

If the tire pressure is too high, reduce the tire pressure with the pressure reducing valve on the compressor.

Minimum tire pressure not reached

Do not continue driving unless a minimum tire pressure of 2.5 bar/36 psi is reached. Contact an authorized service center or another qualified service center or repair shop.

Minimum tire pressure reached

When the tire pressure is at least 2.5 bar/36 psi, proceed as follows:

- Pull the connector out of the socket in the vehicle interior.
- Disconnect the hose from the sealant bottle and from the valve on the wheel.
- Screw the valve cap onto the valve.

4. Stow the tire repair set in the trunk.
5. Immediately drive 6 miles/10 km to ensure that the tire sealant is evenly distributed in the tire.

Do not exceed the speed limit of 50 mph/80 km/h.

If possible, do not drive at speeds less than 12 mph/20 km/h.

Tire sealant may spray from the damaged area when you rotate the wheel initially.

Adjusting the tire pressure

To adjust the tire pressure after using the tire repair set, proceed as follows:

1. Stop at a suitable location.
2. Connect the hose directly to the compressor and turn clockwise by 90° until it audibly engages.
3. Unscrew the valve cap on the wheel and screw the connecting piece of the hose onto the valve.

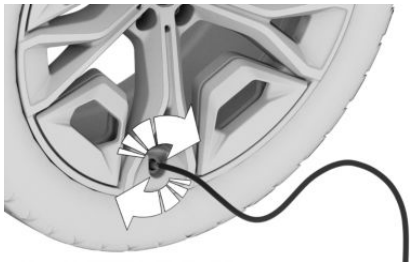

4. Insert the connector into the socket in the vehicle interior.
 5. Read the tire pressure on the tire pressure display of the compressor.
- Do not continue driving unless a minimum tire pressure of 1.3 bar/19 psi is displayed. Contact an authorized service

center or another qualified service center or repair shop.

6. Correct the tire pressure to 2.5 bar/36 psi.
 - To increase the tire pressure when standby or drive-ready state is on: Turn on the compressor and let it run for max. 10 minutes.
 - To decrease the tire pressure: Press the pressure reducing valve button on the compressor.

Removing and stowing the tire repair set

To remove and stow the tire repair set, proceed as follows:

1. Switch off the compressor.
2. Pull the connector out of the socket in the vehicle interior.
3. Disconnect the hose from the compressor and the valve on the wheel.
4. Screw the valve cap onto the valve.
5. Stow the tire repair set together with the hose in the trunk.

Continuing the trip

Continue driving immediately once finished with the tire repair set.

Do not exceed the speed limit of 50 mph/80 km/h.

Do not exceed the maximum travel distance of 125 miles/200 km.

Re-initialize the Flat Tire Monitor or reset the Tire Pressure Monitor.

Replace the faulty tire and the sealant bottle from the tire repair set as soon as possible.

Additional information:

- Flat tire monitor, refer to page 307.
- Tire pressure monitor, refer to page 300.

System limits

If the tire cannot be made drivable, contact an authorized service center or another qualified service center or repair shop.

If vehicle is equipped with Tire Pressure Monitor, note: Using tire sealant can damage the tire pressure sensor. In this case, have the air pressure sensor replaced at the next opportunity.

Snow chains

Safety information

Warning

Mounting snow chains on unsuitable tires can cause the snow chains to come into contact with vehicle parts. There is a risk of accident, injury, or property damage. Only fit snow chains on tires recommended by the vehicle manufacturer for use with snow chains.

Warning

Insufficiently tight snow chains may damage tires and vehicle components. There is a risk of accident, injury, or property damage. Make sure that the snow chains are always sufficiently tight. Re-tighten as needed according to the snow chain manufacturer's instructions.

Fine-link snow chains

The manufacturer of the vehicle recommends the use of fine-link snow chains. Certain types of fine-link snow chains have been tested by the manufacturer of the vehicle and recommended as road-safe and suitable.

For information on suitable snow chains, contact an authorized service center or another qualified service center or repair shop.

Use

Snow chains can only be used in pairs on front wheels of the following wheel/tire sizes:

Tire size	Wheel size	Rim offset (IS)
195/50 R17	5.5J x 17	40

Information on the wheel size and rim offset is located on the inside of the wheel.

The list can also include wheel/tire sizes that are only suitable for certain models.

Information on wheels and tires approved for the vehicle can be requested from an authorized service center or another qualified service center or repair shop.

Follow the instructions of the snow chain manufacturer.

If your vehicle is equipped with a Tire Pressure Monitor, note the following: Do not reset the Tire Pressure Monitor when using snow chains, otherwise incorrect values may be displayed.

If your vehicle is equipped with a Flat Tire Monitor, note the following: Do not initialize the Flat Tire Monitor when using snow chains, otherwise incorrect values may be displayed.

When using with snow chains, activate drive-off support to optimize the drive power as necessary.

Maximum speed with snow chains

When using snow chains, do not exceed a maximum speed of 30 mph/50 km/h.

Tire pressure monitor

Principle

The Tire Pressure Monitor monitors the tire pressure and issues a warning if the tire pressure has dropped.

The sensors in the tire valves measure the tire pressure and tire temperature.

Depending on the tires detected or entered, the system displays the specified nominal pressures on the Interaction Unit and compares these with the current tire pressures.

General information

When using tires not found in the tire inflation pressure specifications on the vehicle, e.g., tires with special approval, the Tire Pressure Monitor must be actively reset. The system will then take over the actual tire inflation pressures as the target pressures.

When operating the system, also note the information found in the Tire inflation pressure chapter.

Additional information:

Tire inflation pressure, refer to page [286](#).

Safety information

Warning

The display of the target pressures is not a substitute for the tire inflation pressure details on the vehicle. Incorrect entries in the tire settings can lead to incorrect target tire inflation pressure values. In this case, it cannot be guaranteed that the notification of a tire pressure loss will be reliable. There is a risk of injury and risk of damage to property. Make sure that the sizes of your mounted tires are displayed correctly and match the information on the

tires and the tire inflation pressure specifications on the vehicle.

Functional requirements

If the following requirements are not met for the Tire Pressure Monitor, tire pressure losses may not be reported reliably:

- Whenever a tire or wheel is changed, this system detects and updates the mounted tires, displaying them on the Interaction Unit after driving for a short time.

Enter the information about the mounted tires in the tire settings when the system does not automatically detect the tires.

- The Tire Pressure Monitor does not activate until after driving for a few minutes:
 - After a tire or wheel change.
 - After a reset, when using tires with special approval.
 - After changing tire settings.
- When using tires with special approval, note the following:
 - After a tire or wheel change, a reset was performed with the correct tire inflation pressure.
 - After the tire inflation pressure was adjusted to a new value, a reset was performed.
- Wheels with tire pressure sensors are mounted.

Tire settings

General information

You can enter information on your mounted tires in the tire settings if the tires are not automatically detected by the system.

The tire sizes of the mounted tires can be gathered from the tire inflation pressure details on the vehicle or directly on the tires.

The tire details do not need to be re-entered when the tire pressure is corrected.

For summer and winter tires, the tire details entered last are stored. After a tire or wheel change, the settings of the tire sets used last can be selected.

Configuring the tire settings

To enter information on equipped tires in the tire settings, proceed as follows:

1. Go through the menu as follows:
Apps menu / "Vehicle" / "Vehicle status" / "Tire Pressure Monitor" / "Tire settings" / "Tire selection" / "Manual" / "Tire type".
2. Select the tire size for the rear axle.
When using tires with special approval:
"Other tires"
Follow the instructions given in the "Performing a reset" section.
3. Select the maximum speed to be driven.
4. "Save tire settings"

The measurement of the current tire inflation pressure is started. The measurement progress is displayed.

Status display

Current status

The status of the Tire Pressure Monitor, e.g., whether this system is active, can be shown on the Interaction Unit.

Go through the menu as follows: Apps menu / "Vehicle" / "Vehicle status" / "Tire Pressure Monitor".

The current status is displayed.

Current tire pressure

The current tire pressure is displayed for each tire.

The current tire inflation pressures may change while driving or depending on the outside temperature.

Nominal pressure

The nominal pressure for the tires on the front and rear axles is displayed.

The specified nominal pressures take the influence of driving and outside temperature on the tire temperature into account. The appropriate nominal pressure is always displayed, independent of the weather situation, tire temperatures and travel times.

The displayed nominal pressure may change and may differ from the tire inflation pressure details on the door pillar of the driver's door. The tire inflation pressure can thus be corrected to the value of the displayed target pressures.

The nominal pressure is immediately adjusted if the vehicle load state is changed in the tire settings.

Tire conditions

General information

The tire condition and system status are indicated by the wheel color and text on the Tire Pressure Monitor on the Interaction Unit.

Any existing messages may not be deleted if the nominal pressure is not reached after the tire inflation pressure is corrected.

All wheels green

On the Interaction Unit, each wheel illuminates green in the Tire Pressure Monitor when the system is active.

- This system bases any warnings on target pressures.
- When using tires with special approval, this system bases any warnings on the last tire pressures saved at the reset.

One to four yellow wheels

In the Tire Pressure Monitor on the Interaction Unit, one to four wheels illuminate if one of the tires shown is flat or has lost a large amount of pressure.

Gray wheels

The wheels illuminate gray on the Interaction Unit if it is not possible to detect a loss of tire pressure.

Possible causes are:

- The system may not be operational.
- After confirming the tire settings, the tire pressure is measured automatically.
- When using tires with special approval: The system is being reset.

For tires with special approval: performing a reset

When using tires with special approval, proceed as follows to reset:

1. Go through the menu as follows: Apps menu / "Vehicle" / "Vehicle status" / "Tire Pressure Monitor".
2. Make sure that the tire settings are correct.
3. Turn on drive-ready state but do not drive off.
4. "Perform reset"
5. Drive off.

The wheels are shown in gray and the tire pressure is reset.

After a travel time of several minutes, the set tire inflation pressures are accepted as the predefined tire inflation pressures. The

reset is completed automatically while driving.

After resetting, the wheels are shown in green on the Interaction Unit and a message appears.

You may interrupt this trip at any time. When you continue driving the reset resumes automatically.

Additional information:

Tire settings, refer to page 300.

Messages: for tires without special approval

General information

When using tires without special approval, the Tire Pressure Monitor may display a message.

When a flat tire is indicated, the Dynamic Stability Control may be turned on.

Safety information

Warning

A damaged regular tire with low or no tire inflation pressure impacts handling such as steering and braking response. Runflat tires can maintain limited stability. There is a risk of accident. Do not continue driving if the vehicle is equipped with normal tires. Follow the information on runflat tires and continued driving with these tires.

If a tire inflation pressure check is required

Message

When using tires without special approval, the Tire Pressure Monitor displays a message if it is necessary for you to check the tire pressure.

An icon with a Check Control message appears on the Interaction Unit.

Icon	Possible cause
	Leak detected on the tire. Inflation was not carried out according to specifications, for instance when the tire has not been sufficiently inflated or in the case of a natural steady tire pressure loss.

Measure

Check the tire pressure and correct as needed.

If the tire inflation pressure is too low

Message

When using tires without special approval, the Tire Pressure Monitor displays a message if the tire pressure is too low.

 A yellow warning light illuminates on the Interaction Unit.

In addition, an icon with a Check Control message appears on the Interaction Unit.

Icon	Possible cause
	There is a tire pressure loss.

Measure

1. Reduce the vehicle speed. Do not continue to exceed a speed of 80 mph/130 km/h.
2. At the next opportunity, for instance at a filling station, check the tire inflation pressure in all four tires and correct if necessary.

If there is a significant tire pressure loss

Message

When using tires without special approval, the Tire Pressure Monitor displays a message if a tire loses a significant amount of pressure.

 A yellow warning light illuminates on the Interaction Unit.

In addition, an icon with the corresponding tire appears in a Check Control message on the Interaction Unit.

Icon	Possible cause
	There is a flat tire or a major tire pressure loss.

Measure

1. Reduce your speed and come to a stop carefully. Avoid sudden braking and steering maneuvers.
2. Check whether the vehicle is fitted with standard tires or runflat tires.
Runflat tires are labeled with a circular icon containing the letters RSC marked on the tire sidewall.
3. Follow the instructions for what to do in case of a flat tire.

Messages: for tires with special approval

General information

When using tires with special approval, the Tire Pressure Monitor may display a message.

When a flat tire is indicated, the Dynamic Stability Control may be turned on.

Safety information

Warning

A damaged regular tire with low or no tire inflation pressure impacts handling such as steering and braking response. Runflat tires can maintain limited stability. There is a risk of accident. Do not continue driving if the vehicle is equipped with normal tires. Follow the information on runflat tires and continued driving with these tires.

If a tire inflation pressure check is required

Message

When using tires with special approval, the Tire Pressure Monitor displays a message if it is necessary for you to check the tire pressure.

An icon with a Check Control message appears on the Interaction Unit.

Icon	Possible cause
------	----------------



Inflation was not carried out according to specifications, e.g., the tire has not been sufficiently inflated.

The system has detected a wheel change, but no reset was done.

The tire inflation pressure has fallen below the level of the last reset.

No reset was performed for the system. The system issues a warning based on the tire inflation pressures stored during the last reset.

Measure

1. Check the tire pressure and correct as needed.
2. Perform a system reset.

If the tire inflation pressure is too low

Message

When using tires with special approval, the Tire Pressure Monitor displays a message if the tire pressure is too low.



A yellow warning light illuminates on the Interaction Unit.

In addition, an icon with a Check Control message appears on the Interaction Unit.

Icon	Possible cause
------	----------------



There is a tire pressure loss. No reset was performed for the system. The system issues a warning based on the tire inflation pressures stored during the last reset.

Measure

1. Reduce the vehicle speed. Do not continue to exceed a speed of 80 mph/130 km/h.
2. At the next opportunity, for instance at a filling station, check the tire inflation pressure in all four tires and correct if necessary.
3. Perform a system reset.

If there is a significant tire pressure loss

Message

When using tires with special approval, the Tire Pressure Monitor displays a message if a tire loses a significant amount of pressure.



A yellow warning light illuminates on the Interaction Unit.

In addition, an icon with the corresponding tire appears in a Check Control message on the Interaction Unit.

Icon	Possible cause
	<p>There is a flat tire or a major tire pressure loss.</p> <p>No reset was performed for the system. The system issues a warning based on the tire inflation pressures stored during the last reset.</p>

Measure

1. Reduce your speed and come to a stop carefully. Avoid sudden braking and steering maneuvers.
2. Check whether the vehicle is fitted with standard tires or runflat tires.
Runflat tires are labeled with a circular icon containing the letters RSC marked on the tire sidewall.
3. Follow the instructions for what to do in case of a flat tire.

Actions in the event of a flat tire

Standard tires

1. In the event of a flat tire, identify the damaged tire.
2. Check the tire pressure in all four tires, for instance using the tire pressure display of a flat tire kit.
For tires with special approval: when the tire pressure in all four tires is correct, the Tire Pressure Monitor may not have been reset. Then perform the reset.
If no tire damage can be identified, contact an authorized service center or an-

other qualified service center or repair shop.

3. Repair the flat tire, e.g., using a tire repair set or by changing the wheel.

The use of sealant, e.g., from the tire repair set, may damage the wheel electronics. Have the electronics replaced at the next opportunity.

Runflat tires

Safety information

Warning

The vehicle handles differently when a runflat tire has insufficient or no tire pressure; for instance, reduced directional stability when braking, braking distances are longer and the self-steering properties will change. There is a risk of accident, injury, or property damage. Drive moderately and do not exceed a speed of 50 mph/80 km/h.

Warning

Vibrations or loud noises while driving can indicate the final failure of a tire. Tire components may come loose. There is a risk of accident, injury, or property damage. Reduce your speed and stop. Do not continue driving. Contact an authorized service center or another qualified service center or repair shop.

Maximum speed

You may continue driving with a damaged tire at speeds up to 50 mph/80 km/h.

Continued driving with a flat tire

Follow the following when continuing to drive with a damaged tire:

1. Avoid sudden braking and steering maneuvers.
2. Do not exceed a speed of 50 mph/80 km/h.
3. Check the tire inflation pressure in all four tires at the next opportunity.

Possible driving distance with a flat tire

The possible driving distance which may be safely traveled varies depending on how the vehicle is loaded and used, e.g., speed, road conditions, outside temperature. The distance traveled may be less but may also be more if an economical driving style is used.

If the vehicle is loaded with an average weight and used under favorable conditions, the possible distance traveled may be up to 50 miles/80 km.

Vehicle handling with damaged tires

Vehicles driven with a damaged tire will handle differently, potentially leading to conditions such as the following:

- Greater likelihood of skidding of the vehicle.
- Longer braking distances.
- Changed self-steering properties.

Modify your driving style. Avoid abrupt steering or driving over obstacles, for instance curbs or potholes.

Final tire failure

Vibrations or loud noises while driving can indicate the final failure of a tire.

Reduce speed and stop; otherwise, pieces of the tire could come loose and cause an accident.

Do not continue driving. Contact an authorized service center or another qualified service center or repair shop.

System limits

Temperature

The tire inflation pressure depends on the tire's temperature.

Driving or exposure to the sun will increase the tire temperature, thus increasing the tire inflation pressure.

The tire inflation pressure is reduced when the tire temperature falls again.

These circumstances may cause a warning when temperatures fall very sharply.

Following a temperature-related warning, the nominal pressures are shown on the Interaction Unit again after driving for a short time.

Sudden tire pressure loss

The system is not able to indicate sudden and serious tire damage and the resulting loss of tire pressure caused by external circumstances.

Failure performing a reset

When using tires with special approval, the system will not function correctly if it has not been reset. For example, a flat tire may be indicated although the tire pressures are correct.

Malfuction

Message

The Tire Pressure Monitor displays a message if the system is not operational.



The yellow warning light flashes and is then illuminated continuously. A Check Control message is displayed.

It may not be possible to identify tire pressure losses.

Measure

If the Tire Pressure Monitor system is not operational, proceed as follows:

- If a wheel without air pressure sensor is mounted, have the wheels checked as necessary.
- Fault due to systems or devices with same transmission frequency: The system reactivates automatically upon leaving the interference zone.
- The system was unable to completely reset when using tires with special approval. Perform a system reset again.
- If the Tire Pressure Monitor has failed: Have the vehicle checked by an authorized service center or another qualified service center or repair shop.

Declaration according to NHTSA/FMVSS 138 Tire Pressure Monitoring System

Each tire, including the spare (if provided) should be checked monthly when cold and inflated to the inflation pressure recommended by the vehicle manufacturer on the vehicle placard or tire inflation pressure label. (If the vehicle has tires of a different size than the size indicated on the vehicle placard or tire inflation pressure label, you should determine the proper tire inflation pressure for those tires.) As an added safety feature, the vehicle has been equipped with a tire pressure monitoring system (TPMS) that illuminates a low tire pressure telltale when one or more of your tires is significantly under-inflated. Accordingly, when the low tire pressure telltale illuminates, you should stop and check your tires as soon as possible, and inflate them to the proper pressure. Driving on a significantly under-inflated tire causes the tire to over-

heat and can lead to tire failure. Under-inflation also reduces fuel efficiency and tire tread life, and may affect the vehicle's handling and stopping ability. Please note that the TPMS is not a substitute for proper tire maintenance, and it is the driver's responsibility to maintain correct tire pressure, even if under-inflation has not reached the level to trigger illumination of the TPMS low tire pressure telltale. The vehicle has also been equipped with a TPMS malfunction indicator to indicate when the system is not operating properly. The TPMS malfunction indicator is combined with the low tire pressure telltale. When the system detects a malfunction, the telltale will flash for approximately one minute and then remain continuously illuminated. This sequence will continue upon subsequent vehicle start-ups as long as the malfunction exists. When the malfunction indicator is illuminated, the system may not be able to detect or signal low tire pressure as intended. TPMS malfunctions may occur for a variety of reasons, including the installation of replacement or alternate tires or wheels on the vehicle that prevent the TPMS from functioning properly. Always check the TPMS malfunction telltale after replacing one or more tires or wheels on the vehicle to ensure that the replacement or alternate tires and wheels allow the TPMS to continue to function properly.

Flat tire monitor

Principle

The flat tire monitor detects a tire pressure loss while driving and issues a warning if the tire pressure has dropped.

The system does not measure the actual inflation pressure in the tires.

The system detects tire pressure loss on the basis of rotation speed differences between the individual wheels while driving.

If a tire loses pressure, the diameter and thus the rotational speed of the corresponding wheel changes. The difference will be detected and reported as a flat tire.

Functional requirements

If the following requirements are not met for the Flat Tire Monitor, a loss in tire pressure may not be reliably reported:

- After a tire or wheel change, an initialization was carried out at the correct tire pressure.
- After the tire pressure was adjusted to a new value, an initialization was performed.

Status display

The current status of the Flat Tire Monitor can be displayed on the Interaction Unit, e.g., to check whether the Flat Tire Monitor is active.

Go through the menu as follows: Apps menu / "Vehicle" / "Vehicle status" / "Flat Tire Monitor".

The status is displayed.

Initialization required

The Flat Tire Monitor must be initialized in the following situations:

- After the tire inflation pressure has been adjusted.
- After a tire or wheel change.

Performing initialization

When initializing, the set tire inflation pressures serve as reference values in order to detect a flat tire. Initialization is started by confirming the tire inflation pressures.

Do not initialize the system when driving with snow chains.

To initialize the Flat Tire Monitor, proceed as follows:

1. Go through the menu as follows: Apps menu / "Vehicle" / "Vehicle status" / "Flat Tire Monitor".
2. Turn on drive-ready state but do not drive off.
3. "Perform reset".
4. Drive off.

The initialization is completed while driving, which can be interrupted at any time.

The initialization automatically continues when driving continues.

Messages

General information

The Tire Pressure Monitor displays a message when a tire is flat.

When a flat tire is indicated, the Dynamic Stability Control (DSC) is turned on, if needed.

Safety information

Warning

A damaged regular tire with low or no tire inflation pressure impacts handling such as steering and braking response. Runflat tires can maintain limited stability. There is a risk of accident. Do not continue driving if the vehicle is equipped with normal tires. Follow the information on runflat tires and continued driving with these tires.

Indication of a flat tire

The Flat Tire Monitor displays a message when a tire is flat.



A yellow warning light illuminates on the Interaction Unit.

In addition, an icon with a Check Control message appears on the Interaction Unit.

Icon	Possible cause
	There is a flat tire or a major tire pressure loss.

Measure

1. Reduce your speed and come to a stop carefully. Avoid sudden braking and steering maneuvers.
2. Check whether the vehicle is fitted with standard tires or runflat tires.
Runflat tires are labeled with a circular icon containing the letters RSC marked on the tire sidewall.
3. Follow the instructions for what to do in case of a flat tire.

Actions in the event of a flat tire

Standard tires

1. In the event of a flat tire, identify the damaged tire.
2. To do this, check the tire pressure in all four tires, for instance using the tire pressure display of a flat tire kit.
When the tire inflation pressure in all four tires is correct, the flat tire monitor may not have been initialized. Then initialize the system.
If tire damage cannot be identified, contact an authorized service center or another qualified service center or repair shop.
3. Repair the flat tire, e.g., using a tire repair set or by changing the wheel.

Runflat tires

Safety information

Warning

The vehicle handles differently when a runflat tire has insufficient or no tire pressure; for instance, reduced directional stability when braking, braking distances are longer and the self-steering properties will change. There is a risk of accident, injury, or property damage. Drive moderately and do not exceed a speed of 50 mph/80 km/h.

Warning

Vibrations or loud noises while driving can indicate the final failure of a tire. Tire components may come loose. There is a risk of accident, injury, or property damage. Reduce your speed and stop. Do not continue driving. Contact an authorized service center or another qualified service center or repair shop.

Maximum speed

You may continue driving with a damaged tire at speeds up to 50 mph/80 km/h.

Continued driving with a flat tire

Follow the following when continuing to drive with a damaged tire:

1. Avoid sudden braking and steering maneuvers.
2. Do not exceed a speed of 50 mph/80 km/h.
3. Check the tire inflation pressure in all four tires at the next opportunity.

When the tire inflation pressure in all four tires is correct, the flat tire monitor may not have been initialized. In this case, initialize the system.

Possible driving distance with a flat tire

The possible driving distance which may be safely traveled varies depending on how the vehicle is loaded and used, e.g., speed, road conditions, outside temperature. The distance traveled may be less but may also be more if an economical driving style is used.

If the vehicle is loaded with an average weight and used under favorable conditions, the possible distance traveled may be up to 50 miles/80 km.

Vehicle handling with damaged tires

Vehicles driven with a damaged tire will handle differently, potentially leading to conditions such as the following:

- Greater likelihood of skidding of the vehicle.
- Longer braking distances.
- Changed self-steering properties.

Modify your driving style. Avoid abrupt steering or driving over obstacles, for instance curbs or potholes.

Final tire failure

Vibrations or loud noises while driving can indicate the final failure of a tire.

Reduce speed and stop; otherwise, pieces of the tire could come loose and cause an accident.

Do not continue driving. Contact an authorized service center or another qualified service center or repair shop.

System limits

The Flat Tire Monitor may react with a delay or malfunction in the following situations:

- A natural, even tire pressure loss in all four tires will not be recognized. There-

fore, check the tire inflation pressure regularly.

- Sudden and serious tire damage caused by external circumstances cannot be recognized in advance.
- The system has not been initialized.
- When driving on a snow-covered or slippery road.
- For sporty driving, e.g., due to slippage on the drive wheels or high lateral acceleration.
- When driving with snow chains.

Changing wheels/tires

General information

When a flat tire kit is used, an immediate wheel change when there is a tire pressure loss in the event of a breakdown is not always necessary.

If necessary, a suitable wheel change tool, e.g., a jack, is available as an accessory from an authorized service center or another qualified service center or repair shop.

Safety information

Warning

The jack is only provided for short-term lifting of the vehicle for wheel changes. Even if all safety precautions are observed, there is a risk of the raised vehicle falling if the jack tips over. There is a risk of injury or danger to life. When the vehicle is raised with the jack, do not lie under the vehicle and do not switch on the drive-ready state.

⚠ Warning

Placing supports, e.g., wooden blocks or similar, under the jack may reduce its ability to bear weight because of the limited height. The load-carrying capacity of the wooden blocks may be exceeded and the vehicle may tip over. There is a risk of injury or danger to life. Do not place supports under the jack.

⚠ Warning

The jack, issued by the vehicle manufacturer, is provided in order to perform a wheel change in the event of a breakdown. The jack is not designed for frequent use, e.g., changing from summer to winter tires. Using the jack frequently may cause it to become jammed or damaged. There is a risk of injury and risk of damage to property. Only use the jack to change an emergency or spare wheel in the event of a breakdown.

⚠ Warning

The jack may slip on soft, uneven, or slippery ground, e.g., snow, ice, tiles, etc. There is a risk of injury. If possible, change the wheel on a flat, solid, slip-resistant surface.

⚠ Warning

The jack is optimized for lifting the vehicle and for the jacking points on the vehicle only. There is a risk of injury. Do not lift any other vehicle or cargo using the jack.

⚠ Warning

When the jack is not inserted into the jacking point provided for this purpose, the vehicle may be damaged or the jack may slip when it is being cranked up. There is a risk of injury or risk of damage to property. When cranking up the jack, ensure that it is inserted in the jacking point next to the wheel well.

⚠ Warning

A vehicle that is raised on a jack may fall off of the jack if lateral forces are exerted on it. There is a risk of injury and risk of damage to property. While the vehicle is raised, do not exert lateral effort on the vehicle or pull abruptly on the vehicle. Have a stuck wheel removed by an authorized service center or another qualified service center or repair shop.

⚠ NOTICE

Using an impact wrench to loosen or tighten the wheel lock bolt can damage the wheel lock bolt. There is a risk of damage to property. Only use a lug wrench to loosen and tighten the wheel lock bolt.

Securing the vehicle against rolling away

General information

The vehicle manufacturer recommends to additionally secure the vehicle against rolling away when changing a wheel.

On a level surface



Place chocks or other suitable objects in front and behind the wheel that is diagonal to the wheel being changed.

On a slight downhill gradient



If it is necessary to change a wheel on a slight downhill gradient, place chocks and other suitable objects, e.g., rocks, under the wheels of the front and rear axles, against the direction that the vehicle will move.

Lug bolt lock

Principle

The wheel bolt lock offers effective protection against wheel theft.

The wheel lug bolts have a special coding. The lug bolts can only be released with the adapter which matches the coding.

Overview

Depending on vehicle equipment, store the lug bolt lock adapter as follows:

- In the cargo area under the cargo floor panel.
- In the cargo area on the left or right side.
- In the cargo area behind a side trim panel.

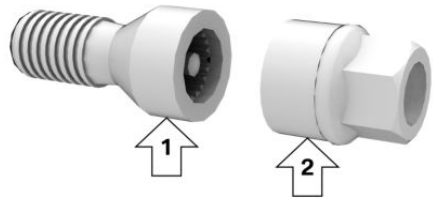

- Lug lock bolt, arrow 1.
- Adapter, arrow 2.

Unscrewing

1. To unscrew, place the adapter on the wheel lock bolt.
2. Unscrew the lug lock bolt.
3. Remove the adapter after unscrewing the lug bolt.

Screwing on

1. To screw on, place the adapter on the wheel lock bolt. Turn the adapter until it fits onto the wheel lock bolt.
2. Screw on the wheel lock bolt. The tightening torque is 101 lbs ft/140 Nm.
3. After screwing on, remove the adapter again.

Safety precautions

Take the following safety measures when changing a wheel:

- Park the vehicle on solid and non-slip ground at a safe distance from road traffic.
- Switch on the hazard warning lights.
- Engage the parking brake.
- Turn the steering wheel until the front wheels are in the straight-ahead position and engage the steering wheel lock.
- Engage a gear or selector lever position P.
- As soon as permitted by the traffic flow, have all vehicle occupants get out and make sure that they remain outside the hazardous area such as behind a guard-rail.
- If necessary, set up the hazard triangle or hazard warning lights at a suitable distance.
- Depending on vehicle equipment, remove the wheel change set and, if necessary, the emergency wheel from the vehicle.
- Secure the vehicle so that it does not roll away.
- Loosen the lug bolts a half turn.

Jacking points

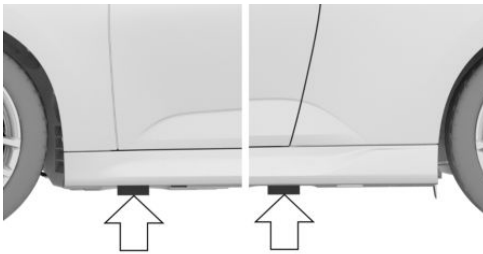

The jacking points are located at the indicated positions.

Jacking up the vehicle

Warning

Hands and fingers can be jammed when using the jack. There is a risk of injury. Comply with the described hand position and do not change this position while using the jack.

To raise the vehicle so that you can change a wheel, proceed as follows:

1. Hold the vehicle jack with one hand, arrow 1, and grasp the jack crank handle or lever with your other hand, arrow 2.

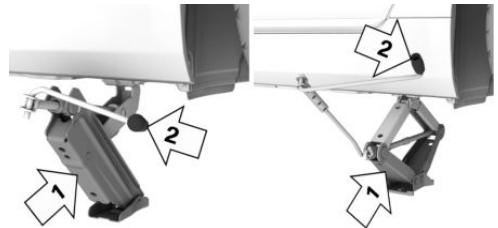

2. Insert the jack into the rectangular recess of the jacking point closest to the wheel to be changed.

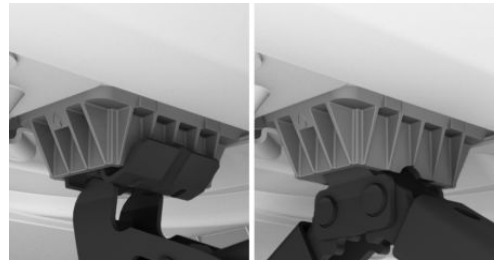

3. Extend the jack by turning the jack crank handle or lever clockwise.



4. Take your hand away from the jack as soon as the jack is under load and continue turning the jack crank handle or lever with one hand.
5. Make sure that the car jack foot extends vertically and is at a right angle beneath the jacking point.

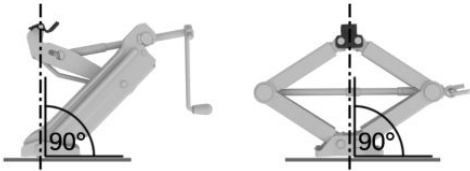

6. Crank the vehicle up until the vehicle jack has the entire surface on the ground and the relevant wheel is maximum 1.2 inches/3 cm above ground.

Mounting a wheel

Mount one emergency wheel only, as required.

To change a wheel, proceed as follows:

1. Unscrew the lug bolts.
2. Remove the wheel.
3. Put the new wheel or emergency wheel on and screw in at least two lug bolts in a crosswise pattern until hand-tight.

When non-original light-alloy wheels of the vehicle manufacturer are mounted, the accompanying lug bolts may have to be used as well.

4. Hand-tighten the remaining lug bolts and tighten all lug bolts well in a crosswise pattern.
5. Turn the jack crank handle counter-clockwise to retract the jack and lower the vehicle.
6. Remove the jack and stow it securely.

After the wheel change

After changing the wheel, do the following:

1. Tighten the lug bolts crosswise. The tightening torque is 101 lbs ft/140 Nm.
2. Stow the faulty wheel in the cargo area, if necessary.
3. Check the tire pressure at the next opportunity and correct as necessary.
4. Re-initialize the Flat Tire Monitor or reset the Tire Pressure Monitor.
5. Check to make sure the lug bolts are tight with a calibrated torque wrench.
6. Drive to the nearest authorized service center or another qualified service center or repair shop, then have the damaged tire replaced.

Engine compartment

Vehicle features and options

This chapter describes model-specific equipment, systems, and functions that are currently available, or may become available

in the future, even if they are not present in the vehicle.

Additional information:

Vehicle equipment, refer to page 8.

Overview

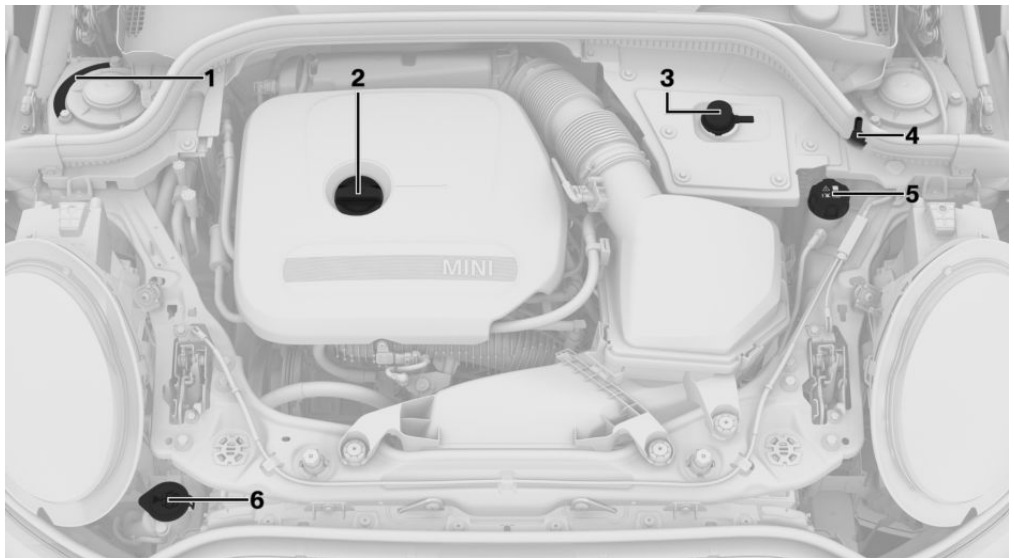

- | | | | |
|---|--|---|--|
| 1 | Vehicle identification number | 4 | Jump-starting, negative battery terminal |
| 2 | Oil filler neck | 5 | Coolant reservoir, engine |
| 3 | Jump-starting, positive battery terminal | 6 | Filler neck for washer fluid |

Hood

Safety information

Warning

Improperly executed work in the engine compartment can damage components and lead to a safety hazard. There is a risk of accident, injury, or property damage. The vehicle manufacturer recommends having work in the engine compartment performed by an authorized service center or another qualified service center or repair shop.

Warning

The engine compartment accommodates moving components. Certain components in the engine compartment can also move with the vehicle switched off, for instance the radiator fan. There is a risk of injury. Do not reach into the area of moving parts. Keep articles of clothing and hair away from moving parts.

Warning

There are protruding parts, for instance locking hooks, on the inside of the hood. There is a risk of injury. If the hood is open, pay attention to protruding parts and keep clear of these areas.

Warning

An incorrectly locked hood can open while driving and restrict visibility. There is a risk of accident, injury, or property damage. Stop immediately and correctly close the hood.

Warning

Body parts can be jammed when opening and closing the hood. There is a risk of injury. Make sure that the area of movement of hood is clear while opening and closing.

NOTICE

Folded-out wipers can be jammed when the hood is opened. There is a risk of damage to property. Make sure that the wipers with the wiper blades mounted are folded down onto the windshield before opening the hood.

NOTICE

When the hood is closed, it must engage on both sides. Pressing again can damage the hood. There is a risk of damage to property. Open the hood again and then close it energetically. Avoid pressing again.

Opening hood

1. In the footwell, pull the lever to open the hood, arrow 1.
Hood is unlocked.



2. Release the lever and pull it again, arrow 2.

Hood can be opened.

3. Be careful of protruding parts on the hood.

Closing the hood

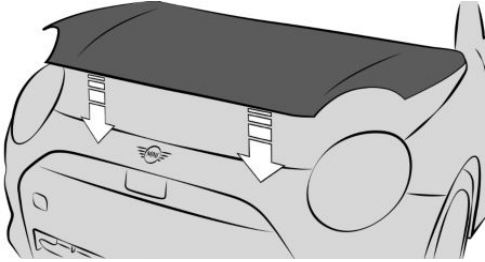

Energetically close the hood from approx. 20 in/50 cm.

The hood must engage on both sides.

Operating fluids

Vehicle features and options

This chapter describes model-specific equipment, systems, and functions that are currently available, or may become available in the future, even if they are not present in the vehicle.

Additional information:

Vehicle equipment, refer to page 8.

Fuel recommendation

General information

Depending on the region, many filling stations sell fuel that has been customized to winter or summer conditions. Fuel that is available in winter, for instance helps make a cold start easier.

Gasoline

General information

For the best fuel efficiency, the gasoline should be sulfur-free or very low in sulfur content.

Fuels that are marked on the gas pump as containing metal must not be used.

Fuels with a maximum ethanol content of 10 %, i.e., E10, may be used for refueling.

The power and consumption specifications correspond to operation with 98 RON E10 fuel.

Knocking noises and driving/acoustic problems may occur when using minimum quality fuel, e.g., 87 AKI, or fuel with an ethanol content of more than 10 % to max. 15 %.

These have no effect on the engine service life.

Safety information

Caution

The use of poor-quality fuels may result in harmful engine deposits or damage. Additionally, problems relating to drivability, starting and stalling, especially under certain environmental conditions such as high ambient temperature and high altitude, may occur.

If drivability problems are encountered, we recommend switching to a high quality gasoline brand and a higher octane grade — AKI number — for a few tank fills. To avoid harmful engine deposits, it is highly recommended to purchase gasoline from Top Tier retailers.

Failure to comply with these recommendations may result in the need for additional maintenance.

Warning

Even small quantities of the wrong fuel or wrong fuel additives can damage the fuel system and engine. Furthermore, the catalytic converter can be permanently damaged. There is a risk of injury and risk of damage to property. Do not refuel or add the following in the case of gasoline engines:

- Leaded gasoline.
- Metallic additives, for instance manganese or iron.

Do not turn on standby after refueling with the wrong fuel. Contact an authorized service center or another qualified service center or repair shop.

⚠ NOTICE

Fuel that does not meet the minimum quality requirements can cause the engine to malfunction or become damaged. There is a risk of damage to property. Do not fill with fuel that does not comply with the minimum quality.

⚠ NOTICE

Incorrect fuels can damage the fuel system and the engine. There is a risk of damage to property. Do not use fuels with a higher ethanol content than recommended. Do not refuel with fuels containing methanol, e.g. M5 to M100.

Recommended gas quality

MINI recommends AKI 91.

Minimum fuel grade

MINI recommends AKI 87.

If you use gasoline with this minimum AKI Rating, the engine may produce knocking sounds when starting at high external temperatures. This has no effect on the engine life.

Engine oil**Principle**

The engine oil consumption and engine oil properties depend on the driving style and operating conditions.

Therefore, regularly check the engine oil level after refueling by taking a detailed measurement.

The engine's oil consumption may increase in situations like the following:

- Sporty driving style.
- Break-in of the engine.
- Idle operation of the engine.
- With use of engine oil types that are not recommended.

Different Check Control messages appear on the Interaction Unit depending on the engine oil level and engine oil properties.

The vehicle manufacturer recommends having engine oil changed by an authorized service center or another qualified service center or repair shop.

Safety information**⚠ NOTICE**

An engine oil level that is too low causes engine damage. There is a risk of damage to property. Immediately add engine oil.

⚠ NOTICE

Too much engine oil can damage the engine or the catalytic converter. There is a risk of damage to property. Do not add too much engine oil. If there is excess engine oil, have the engine oil level corrected by an authorized service center or another qualified service center or repair shop.

⚠ NOTICE

Engine oil that is not changed in timely fashion can cause increased engine wear and thus engine damage. There is a risk of damage to property. It is recommended that you do not exceed the service intervals indicated in the vehicle.

Electronic oil measurement

General information

The electronic oil measurement has two measuring principles:

- Monitoring.
- Detailed measurement.

When making frequent short-distance trips or using a sporty driving style, for instance when cornering aggressively, regularly perform a detailed measurement.

Monitoring

Principle

The engine oil level is monitored electronically while driving and can be shown on the MINI Interaction Unit.

If the engine oil level is outside its permissible operating range, a Check Control message is displayed.

Functional requirement

To use the electronic oil measurement, the following functional requirement must be met:

A current measured value is available after approx. 30 minutes of normal driving.

Displaying the engine oil level

To display the engine oil level, go through the menu as follows: Apps menu / "Vehicle" / "Vehicle status" / "Engine oil level".

System limits

When making frequent short-distance trips or using a sporty driving style, it may not be possible to calculate a measured value. In this case, the measured value for the last, sufficiently long trip is displayed.

Detailed measurement

Principle

During a detailed measurement, the engine oil level is checked when the vehicle is stationary and displayed on a scale.

If the engine oil level is outside its permissible operating range, a Check Control message appears on the Interaction Unit.

General information

The idle speed increases slightly while the engine oil level is measured.

Functional requirements

Note the following functional requirements for detailed measurement:

- The vehicle is parked in a horizontal position.
- Drive-ready state is turned on by pressing the Start/Stop switch.
- The engine is at operating temperature.
- Selector lever is in selector lever position N or P and accelerator pedal not pressed.

Performing a detailed measurement

To perform a detailed measurement of the engine oil level, go through the menu as follows: Apps menu / "Vehicle" / "Vehicle status" / "Engine oil level" / "Oil level measurement" / "Start measurement".

The engine oil level is checked and displayed via a scale.

Adding engine oil

Principle

Only add engine oil when the message is displayed. The top-up quantity is indicated in the message.

Only add suitable types of engine oil.

Safely park the vehicle and switch off drive-ready state before adding engine oil.

Take care not to add too much engine oil.

Safety information

Warning

Operating fluids, e.g., oil, grease, coolant, fuel, may contain harmful ingredients. There is a risk of injury or danger to life. Follow the instructions on the containers. Do not allow operating fluids to come into contact with your clothing, skin, or eyes. Do not fill operating fluids into different bottles. Store operating fluids out of reach of children.

NOTICE

An engine oil level that is too low causes engine damage. There is a risk of damage to property. Immediately add engine oil.

NOTICE

Too much engine oil can damage the engine or the catalytic converter. There is a risk of damage to property. Do not add too much engine oil. If there is excess engine oil, have the engine oil level corrected by an authorized service center or another qualified service center or repair shop.

Overview

The oil filler neck is located in the engine compartment.

Additional information:

For an overview, refer to page [315](#).

Adding engine oil

To top up the engine oil, proceed as follows:

1. Opening the hood.
2. Open the cap in the engine compartment by turning it counterclockwise.



3. Add engine oil.
4. Close the cap in the engine compartment.

Additional information:

Opening the hood, refer to page [316](#).

Engine oil types to add

General information

The engine oil grade is critical for the service life of the engine.

Only add with the types of engine oil which are listed.

Safety information

NOTICE

Oil additives can damage the engine. There is a risk of damage to property. Do not use oil additives.

⚠ NOTICE

Incorrect engine oil can cause malfunctions in the engine or damage it. There is a risk of damage to property. When selecting an engine oil, make sure that the engine oil has the correct oil specification.

Suitable engine oil types

When topping up engine oil, the following oil specification applies:

Gasoline engine

BMW Longlife-17 FE+.

Alternative engine oil types

If an engine oil suitable for continuous use is not available, up to 1 US quart/liter of an engine oil with the following oil rating can be added:

Oil specification

API SL.

API SM.

API SN.

Viscosity grades

When selecting an engine oil, make sure that the engine oil has a suitable viscosity grade. The suitable viscosity grade is indicated on a sign in the engine compartment.

Viscosity grades

SAE 0W-20.

More information about suitable oil specifications and engine oil viscosity grades can be requested from an authorized service center or another qualified service center or repair shop.

**MINI recommends
MINI Original Engine Oil.**

Coolant**General information**

Coolant consists of water and a coolant additive.

Not all commercially available coolant additives are suitable for the vehicle. The vehicle manufacturer recommends using coolant additive with BMW LC-18 specification. Do not mix coolant additives of different colors. Use a 50:50 mixing ratio of water to coolant additive. Information on suitable coolant additives can be provided by an authorized service center or another qualified service center or repair shop.

Safety information**⚠ Warning**

With the engine hot and the cooling system open, coolant can escape and lead to scalding. There is a risk of injury. Only open the cooling system with the engine cooled down.

⚠ Warning

Additives are harmful and incorrect additives can damage the engine. There is a risk of injury and risk of damage to property. Do not allow additives to come into

contact with skin, eyes or articles of clothing. Use suitable additives only.

Coolant level

General information

The coolant reservoir may be overfilled with coolant when the vehicle is delivered from the factory or following maintenance and repair work. The specified coolant level is achieved with longer operating periods.

The nominal coolant level is indicated by the maximum mark in the filler neck of the coolant reservoir.

Additional information:

For an overview, refer to page [315](#).

Checking the coolant level

1. Allow the engine to cool down.
2. Turn off the climate control system.
3. Opening the hood.
4. Turn the coolant reservoir cap slightly counterclockwise until the excess pressure dissipates.
5. Open the coolant reservoir cap.
6. The coolant level is correct when it is just below the max. level mark on the filler neck.

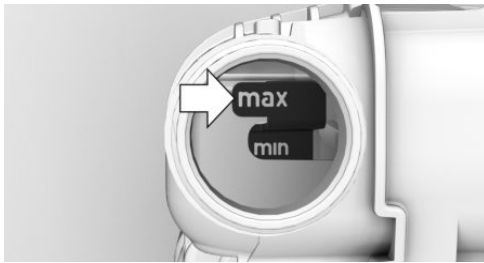

Additional information:

Climate control, refer to page [244](#).

Opening the hood, refer to page [316](#).

Adding coolant

To refill the coolant, proceed as follows:

1. Allow the engine to cool down.
2. Turn off the climate control system.
3. Opening the hood.
4. Turn the coolant reservoir cap slightly counterclockwise until the excess pressure dissipates.
5. Open the coolant reservoir cap.
6. If the coolant is low, slowly add coolant up to the specified fill level; do not overfill.
7. Close the cap.

Additional information:

Climate control, refer to page [244](#).

Opening the hood, refer to page [316](#).

Disposal



Comply with the relevant environmental protection regulations when disposing of coolant and coolant additives.

Washer fluid

Principle

Washer fluid is used to clean the windshields and sensors. All spray nozzles are supplied from one tank.

Use a mixture of tap water and windshield washer concentrate. If desired, a windshield washer concentrate containing antifreeze can be used.

Recommended minimum fill quantity:
0.4 US gal/2 liters.

Safety information

Warning

Some types of antifreeze can contain harmful substances and are flammable. There is a risk of fire and an injury hazard. Follow the instructions on the containers. Keep antifreeze away from ignition sources. Do not fill operating fluids into different bottles. Store operating fluids out of reach of children.

United States: the washer fluid mixture ratio is regulated by the U.S. EPA and many individual states; do not exceed the allowable washer fluid dilution ratio limits that apply. Follow the usage instructions on the washer fluid container.

Use of BMW's Windshield Washer Concentrate or the equivalent is recommended.

Warning

Washer fluid can ignite and catch fire on contact with hot engine parts. There is a risk of injury or risk of damage to property. Only add washer fluid when the engine is cooled down. Next, fully close the lid of the washer fluid reservoir.

NOTICE

Silicon-containing additives in the washer fluid for the water-repelling effect on the windows can lead to damage to the car wash. There is a risk of damage to property. Do not add silicon-containing additives to the washer fluid.

NOTICE

Mixing different windshield washer fluid concentrates or antifreeze can damage the washer system. There is a risk of damage to property. Do not mix different windshield washer fluid concentrates or antifreeze. Follow the information and mixture ratios provided on the containers.

Overview



The washer fluid reservoir is located in the engine compartment.

Malfuction

The use of undiluted windshield washer fluid concentrate or alcohol-based antifreeze can lead to incorrect readings at temperatures below +5 °F/-15 °C.

Maintenance

Vehicle features and options

This chapter describes model-specific equipment, systems, and functions that are currently available, or may become available in the future, even if they are not present in the vehicle.

Additional information:

Vehicle equipment, refer to page 8.

Maintenance system

Principle

The maintenance system provides service notifications and thereby provides support in maintaining road safety and the operational reliability of the vehicle.

General information

In some cases, scopes and intervals of the maintenance system may vary according to the country version. Replacement work, spare parts, fuels and lubricants, and wear materials are calculated separately. Further information is available from an authorized service center or another qualified service center or repair shop.

Condition Based Service

Principle

Condition Based Service determines the maintenance recommendation using sensors and special algorithms that take into account the operating conditions of the vehicle.

Information on service notifications can be displayed on the Interaction Unit.

Additional information:

Service notifications, refer to page 146.

Service data in the vehicle key

Information on the service notifications is continuously stored in the vehicle key. An authorized service center can read this data out and suggest a maintenance scope for the vehicle.

Therefore, hand the service advisor the vehicle key with which the vehicle was driven most recently.

Stationary periods

Stationary periods during which the vehicle battery was disconnected are taken into account.

Some maintenance measures are time-dependent, e.g., replacing operating fluids. Have this maintenance work updated by an authorized service center or another qualified service center or repair shop.

Maintenance Booklet for US Models

Please consult your Maintenance Booklet for additional information on the performance of service and maintenance work.

The manufacturer of the vehicle recommends that maintenance and repair be performed by an authorized service center or another qualified service center or repair shop. Records of regular maintenance and repair work should be retained.

Diagnostic socket

Principle

Using the diagnostic socket, the vehicle owner can also have data saved to the vehicle read out, for a fee as required, by an authorized service center or another qualified service center or repair shop.

General information

Disconnect devices from the diagnostic socket before locking the vehicle.

Additional information:

Indicator/warning lights, refer to page 134.

Safety information

NOTICE

The socket for Onboard Diagnosis is an intricate component intended to be used in conjunction with specialized equipment to check the vehicle's primary emissions system. Improper use of the socket for Onboard Diagnosis, or contact with the socket for Onboard Diagnosis for other than its intended purpose, can cause vehicle malfunctions and creates risks of personal and property damage. As such, it is strongly recommended that access to the diagnostic socket be limited to an authorized service center or another qualified service center or repair shop, or other persons who have specialized training and equipment and who are able to use the diagnostic socket correctly.

Overview

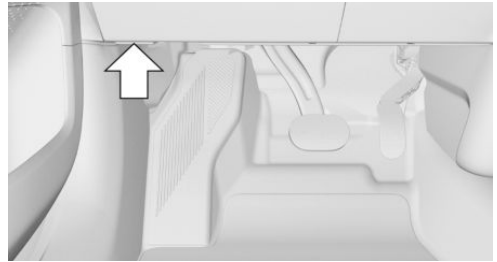

The diagnostic socket for reading out vehicle data is located on the driver's side.

Exhaust emissions



- The warning light illuminates:
The exhaust gas quality is declining, e.g., because the fuel filler cap is fitted incorrectly. Have the vehicle checked as soon as possible.
- The warning light flashes under certain circumstances:
This indicates that there is excessive misfiring in the engine.
Reduce the vehicle speed and have the vehicle checked immediately; otherwise, serious engine misfiring within a brief period can seriously damage emission control components, in particular the catalytic converter.
Have the vehicle checked by an authorized service center or another qualified service center or repair shop.

Taking the vehicle out of service

When the vehicle is shut down for longer than three months, special measures must be taken. For more information, contact an

authorized service center or another qualified service center or repair shop.

Additional information:

Deep sleep mode, refer to page [40](#).

Replacing components

Vehicle features and options

This chapter describes model-specific equipment, systems, and functions that are currently available, or may become available in the future, even if they are not present in the vehicle.

Additional information:

Vehicle equipment, refer to page 8.

Onboard vehicle tool kit



The onboard vehicle tool kit is located under the cargo area floor.

Wiper blades

Safety information

⚠ NOTICE

The window may sustain damage if the wiper falls onto it without the wiper blade installed. There is a risk of damage to property. Hold the wiper firmly when changing the wiper blade. Do not fold in or switch on the wiper without a wiper blade installed.

⚠ NOTICE

Folded-out wipers can be jammed when the hood is opened. There is a risk of damage to property. Make sure that the wipers with the wiper blades mounted are folded down onto the windshield before opening the hood.

Replacing the front wiper blades

To replace the front wiper blades, proceed as follows:

1. Move the wipers to the fold-out position.
2. Lift the wipers off the windshield and hold.



3. Press the button on the wiper, arrow 1, turn the wiper blade clockwise slightly, then pull it forward and out, arrow 2.

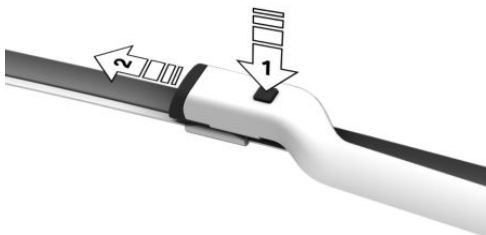

4. Insert the new wiper blade by pressing it on until you hear it snap into the holder.
5. Fold in the wipers.

Additional information:

Fold-out position of the wipers, refer to page 159.

Replacing the rear wiper blade

The rear wiper blade is engaged on the end of the wiper arm. To replace the wiper blade, proceed as follows:

1. Fold out the wiper arm and pull off the wiper blade, arrow.



2. Attach the new wiper blade. The wiper blade must engage audibly.
3. Fold in the wiper arm.

Lights and bulbs

Principle

The bulbs and lights contribute significantly to driving safety.

All headlights and lights are designed using LED technology at least.

In the event of a malfunction, the vehicle manufacturer recommends having any necessary work performed by an authorized service center or another qualified service center or repair shop.

Safety information

Warning

Intense brightness can irritate or damage the retina of the eye. There is a risk of injury. Do not look directly into the headlights or other light sources. Do not remove the LED covers.

Headlight glass

The inside of the headlight glass may fog up in cool or damp weather. Condensation will disappear after a short time when driving with the lights on. The headlight glass does not need to be changed.

If, despite driving with the headlights switched on, moisture such as water droplets increasingly forms in the light, have the headlights checked.

Vehicle battery

Principle

The vehicle battery is maintenance-free. More information on the vehicle battery can be requested from an authorized service center or another qualified service center or repair shop.

Safety information

DANGER

Contact with live components can lead to an electric shock. There is a risk of injury or danger to life. Do not touch any components that are under voltage.

Warning

Vehicle batteries that are not recommended can damage vehicle systems and impair vehicle functions. There is a risk of accident, injury, or property damage. Only use vehicle batteries recommended by the vehicle manufacturer. For information on suitable vehicle batteries, contact an authorized service center or another qualified service center or repair shop.

Registering the vehicle battery in the vehicle

The vehicle manufacturer recommends having an authorized service center or another qualified service center or repair shop register the vehicle battery to the vehicle after the battery has been changed. Once the battery has been registered again, all comfort features will be available without limitation and any Check Control messages displayed which relate to comfort features will disappear.

Charging the vehicle battery

Principle

Make sure that the vehicle battery is always sufficiently charged to ensure that the vehicle battery can be used for its entire service life.



A discharged battery is indicated by a red indicator light.

Charge the vehicle battery when the drive-off power is insufficient.

The following circumstances can negatively affect the vehicle battery's performance:

- Frequent short-distance drives.
- Stationary periods of more than one month.

Safety information

Warning

Battery chargers that charge the vehicle battery via sockets or cigarette lighters in the vehicle may overload or damage the 12 V electrical system. There is a risk of injury or risk of damage to property. Only connect battery chargers for the vehicle battery to the jump-start terminals in the engine compartment.

Charging the vehicle battery

To charge the vehicle battery, first switch off the engine, then use the jump-start terminals in the engine compartment.

Additional information:

Jump-start terminals, refer to page [336](#).

Power interruption

After a power interruption, some equipment needs to be newly initialized or individual settings updated, for example:

- Initialize the parking brake.
- With memory function: Save the positions again.
- Update the time.
- Update the date.
- With glass sunroof: Initialize the system.

Additional information:

Initialize the parking brake after a power interruption, refer to page [127](#).

Deep sleep mode

Use deep sleep mode for long stationary periods.

Additional information:

Deep sleep mode, refer to page [40](#).

Disposing of old batteries



Have old batteries disposed of by an authorized service center or another qualified service center or repair shop, or take them to a collection point. Transport and store the filled vehicle battery in an upright position. Secure the battery so that it does not tip over during transport.

Fuses

General information

The fuses are located at different places in the vehicle.

Information on the fuse layout and the locations of fuse boxes is provided online: mini.com/fusecard.

Safety information

Warning

Incorrect and repaired fuses can overload electrical lines and components. There is a risk of fire. Never attempt to repair a blown fuse. Do not replace a nonworking fuse with a substitute of another color or amperage rating.

Replacing fuses

The vehicle manufacturer recommends having the fuses replaced by an authorized service center or another qualified service center or repair shop.

Breakdown Assistance

Vehicle features and options

This chapter describes model-specific equipment, systems, and functions that are currently available, or may become available in the future, even if they are not present in the vehicle.

Additional information:

Vehicle equipment, refer to page 8.

Hazard warning system



The button for the hazard warning system is located on the switch cluster.

The red light in the button flashes when the hazard warning system is turned on.

Warning triangle

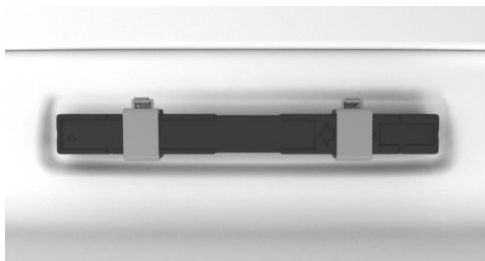

The warning triangle is located in the tailgate.

To remove, loosen the bracket.

First-aid kit

Depending on the vehicle equipment and national-market version, the vehicle is equipped with a first-aid kit.

Storage for the first-aid kit is provided under the cargo area floor.

Some of the articles have a limited service life. Check the expiration dates for the contents regularly, replacing any expired items promptly.

MINI Assistance

Principle

MINI Assistance includes various services for the vehicle, e.g., customer support. The services help maintain mobility.

General information

The offering depends on the vehicle equipment and the national-market version.

For more information on possible services, the vehicle manufacturer recommends contacting an authorized service center or Customer Relations/Customer Support.

Starting services

1. To start MINI Assistance, go through the menu as follows: Apps menu / "All" / "MINI Assist".
2. Select the MINI Assistance option.

A voice connection to Customer Relations/customer support is being established.

MINI Roadside Assistance

Principle

MINI Roadside Assistance can be contacted if assistance is required following an accident.

General information

In the event of a breakdown, data on the vehicle's condition is sent to MINI Roadside Assistance.

There are various ways to contact MINI Roadside Assistance:

- Via additional text in the Check Control message.
- Via a call with a mobile phone.

Functional requirements

The following functional requirements must be met for MINI Roadside Assistance:

- An active MINI Connected contract, vehicle equipped with Intelligent Emergency Call or MINI Connected Services.
- Vehicle must have mobile network reception.
- Standby state is switched on.

Starting MINI Roadside Assistance manually

If the vehicle is equipped with Teleservices, support is first offered through Teleservice Diagnosis and, where applicable, then through Teleservice Help.

MINI Roadside Assistance can be started manually as follows:

1. Go through the menu as follows: Apps menu / "All" / "MINI Assist".
2. "MINI Roadside Assistance" or select the desired service.

Note the views shown on the Interaction Unit. A voice connection is established as necessary.

Teleservice Diagnosis

Teleservice Diagnostics enables detailed vehicle data to be transmitted via mobile communications, which is necessary for vehicle diagnosis. This data is transmitted automatically. It may be necessary to approve this on the Interaction Unit.

Teleservice Help

Depending on the country, Teleservice Help enables an in-depth diagnosis of the vehicle by MINI Roadside Assistance via wireless transmission.

You can launch Teleservice Help by requesting it through MINI Roadside Assistance.

1. Park vehicle in a safe place.
2. Engage the parking brake.

3. Turn on the Interaction Unit.
4. Consent to Teleservice Help.

MINI Accident Assistance

Principle

MINI Accident Assistance can be contacted if assistance is required following an accident.

General information

If the vehicle sensors detect a minor to moderately severe accident in which the airbags did not deploy, a Check Control message is displayed on the Interaction Unit.

When MINI Accident Assistance is triggered, data on the vehicle's condition is sent to MINI.

Functional requirements

The following functional requirements must be met for MINI Accident Assistance:

- An active MINI Connected contract, vehicle equipped with Intelligent Emergency Call or MINI Connected Services.
- Vehicle must have mobile network reception.
- Standby state is switched on.

Starting MINI Accident Assistance

If an accident is detected automatically

Text for MINI Accident Assistance appears on the Interaction Unit.

The connection can be established directly: "Contact accident assistance"

The Check Control message for MINI Accident Assistance can also be brought up

from saved Check Control messages for a certain time.

Additional information:

Check Control, refer to page 133.

Starting MINI Accident Assistance manually

MINI Accident Assistance can also be contacted independently of the automatic accident detection function.

MINI Accident Assistance can be started manually as follows:

1. Go through the menu as follows: Apps menu / "All" / "MINI Assist".
2. "MINI Accident Assistance" or select the desired service.

Note the views shown on the Interaction Unit. A voice connection is established.

Emergency Call

Principle

In case of an emergency, an emergency call can be triggered automatically by the system or manually.

Intelligent emergency call

The vehicle features an Intelligent Emergency Call system, depending on vehicle equipment.

The Intelligent Assist system establishes a connection with the MINI Response Center.

Intelligent emergency calls are made using a SIM card that is integrated into the vehicle.

The MINI Response Center then makes contact with the vehicle occupants and initiates further action to help.

If an intelligent emergency call is made, the data used to determine necessary rescue

measures, e.g., the current location of the vehicle when it can be determined, is transmitted to the MINI Response Center.

Even if the driver is unable to respond, the MINI Response Center can, under certain circumstances, initiate steps to provide further assistance.

Even if the MINI Response Center can no longer be heard through the loudspeakers, the MINI Response Center may still be able to hear the vehicle occupants.

The MINI Response Center ends the emergency call.

General information

Only press the SOS button in the headliner in an emergency.

For technical reasons, the emergency call cannot be guaranteed under unfavorable conditions.

Overview

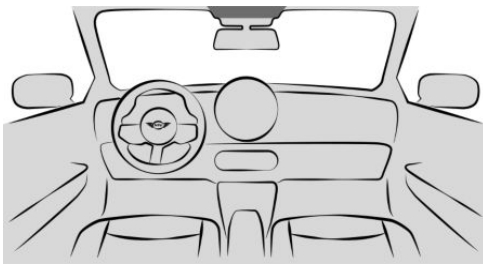

 The SOS button is located in the headliner.

Functional requirements

To use the emergency call, the following functional requirements must be met:

- Standby state is switched on.
- The Emergency Call system is functioning correctly.
- The integrated SIM card in the vehicle has been activated.

Automatic triggering

Under certain conditions, for example if the airbags are deployed, an emergency call is automatically triggered immediately after an accident of corresponding severity. Automatic Collision Notification is not affected by pressing the SOS button.

If an emergency call is placed, all other signal tones and audio sources such as the Park Distance Control are muted.

Manual triggering

To initiate an emergency call manually, proceed as follows:

1. Tap the cover flap.
2. Press and hold the SOS button in the headliner until the LED near the button illuminates green.

- The LED is illuminated green when an Emergency Call has been initiated.

If a cancel prompt appears on the control display, the emergency call can be aborted.

If the situation allows, wait in the vehicle until the voice connection has been established.

- The LED flashes green when the connection to the MINI Response Center has been established.

Malfunction

The function of the emergency call may be impaired.

The LED near the SOS button flashes for approximately 30 seconds. A Check Control message is displayed.

Have the vehicle checked by an authorized service center or another qualified service center or repair shop.

Jump-starting

Principle

If the vehicle battery is discharged, the engine can be started using the battery on another vehicle and two jumper cables. Only use jumper cables with fully insulated clamp handles.

Safety information

DANGER

Contact with live components can lead to an electric shock. There is a risk of injury or danger to life. Do not touch any components that are under voltage.

Warning

If the jumper cables are connected in the incorrect order, spark formation may occur. There is a risk of injury. Pay attention to the correct order during connection.

Warning

In the case of body contact between the two vehicles, a short circuit can occur while jump-starting. There is a risk of injury or risk of damage to property. Make sure that no body contact occurs.

Preparation

1. Check whether the vehicle battery of the other vehicle has a voltage of 12 volts.

The voltage information can be found on the vehicle battery.

2. Switch off the engine on the donor vehicle.
3. Switch off any power consumers in both vehicles.

Jump-start terminals

The jump-start terminals are located in the engine compartment.

Open the covers of the jump-start terminals.

Additional information:

For an overview, refer to page [315](#).

Connecting jumper cables

Before starting, turn off all unnecessary electronic systems/components, e.g., radio, on the donor and receiver vehicles.

1. Open the lid of the jump-start terminal.
2. Attach one terminal clamp of the positive jumper cable to the positive battery terminal, or to the corresponding jump-start terminal of the vehicle providing assistance.
3. Attach the second terminal clamp to the positive battery terminal, or to the corresponding jump-start terminal, of the vehicle being started.
4. Attach one terminal clamp of the negative jumper cable to the negative battery terminal, or to the corresponding engine or body ground of assisting vehicle.
5. Attach the second terminal clamp to the negative battery terminal, or to the corresponding engine/body ground, of the vehicle being started.

Starting the engine

Never use spray fluids to start the engine.

1. Start the engine on the donor vehicle and let it run for several minutes at an increased idle speed.

If the vehicle being started has a diesel engine: Let the donor vehicle's engine run for approx. 10 minutes.

2. Start the engine on the vehicle to be started as usual.

If the first attempt to start the engine is not successful, wait a few minutes before making another attempt in order to allow the discharged battery to recharge.

3. Let both engines run for several minutes.
4. Disconnect the jumper cables again in the reverse order.

Check the vehicle battery and recharge, if needed.

Tow-starting and towing

Safety information

Warning

When towing while safety systems or driver assistance systems are activated, the behavior of the individual systems may lead to an accident, e.g., due to automatic braking or acceleration. There is a risk of accident, injury, or property damage. Do not use the corresponding safety systems or driver assistance systems when towing.

Pushing the vehicle

To remove a broken-down vehicle from the hazard area, it can be pushed for distances

of approx. 328 ft/100 m at a speed of max. 6 mph/10 km/h.

Additional information:

Rolling or pushing the vehicle, refer to page 119.

Transporting the vehicle

Principle

When towing the vehicle, make sure to tow it in the direction of traffic.

The vehicle must be transported by an authorized service center or another qualified service center or repair shop.

Safety information

NOTICE

The vehicle can be damaged when towing the vehicle while the front wheels are rolling. There is a risk of damage to property. The front axle must be raised when the vehicle is towed, and the vehicle must be transported on a loading platform or using a tow dolly. Tow dollies must be used under the rear wheels only. Also make sure that no wheel is touching the ground.

Warning

The vehicle can become damaged when lifting and securing it.

There is a risk of injury or risk of damage to property.

- Lift the vehicle using suitable means.
- Do not lift or secure the vehicle by its towing eye, body parts, or suspension parts.

Tow truck

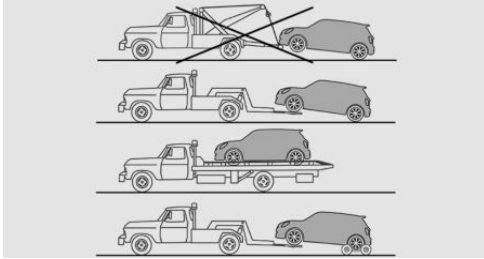

The vehicle should be transported with a tow truck with a so-called spectacle lift or on a loading platform.

When using a tow dolly, make sure that none of the wheels touch the ground. This method should be used for distances of 124 miles/200 km. Follow the instructions, as well as specified loads and speeds, given by the tow dolly manufacturer.

Towing other vehicles

Principle

Switch on the hazard warning system, depending on local regulations.

If the electrical system fails, mark the vehicle being towed clearly by placing a sign or warning triangle in the rear window.

Safety information

Warning

If the approved gross vehicle weight of the towing vehicle is lighter than the vehicle to be towed, the towing eye can tear off or it will not be possible to control vehicle handling. There is a risk of accident, injury, or property damage. Make sure that the gross vehicle weight of the towing vehicle is heavier than the vehicle to be towed.

Warning

Different levels of braking may occur when towing with adaptive recuperation. There is a risk of accident, injury, or property damage. Deactivate adaptive recuperation before towing.

NOTICE

If the tow bar or tow rope is attached incorrectly, damage to other vehicle parts can occur. There is a risk of damage to property. Correctly attach the tow bar or tow rope to the towing eye.

Tow bar

The towing eyes used should be on the same side on both vehicles.

If it is not possible to avoid mounting the tow bar at an incline, note the following:

- Free movement will be restricted when cornering.
- The inclination of the tow bar will generate lateral forces.

Tow rope

Observe the following notes when using the tow rope:

- Use nylon ropes or straps, which will enable the vehicle to be towed without jerking.
- Make sure the tow rope is not twisted when fastening.
- Check the attachment of the towing eye and tow rope in regular intervals.
- Do not exceed a towing speed of 30 mph/50 km/h.

- Do not exceed a towing distance of 3 miles/5 km.
- When driving off to tow the vehicle, make sure that the tow rope is taut.

Towing eye

Principle

The towing eye is a device that can be screwed onto the vehicle in order to, e.g., secure tow cables or tow rods.

General information



The screw-in towing eye should always be carried in the vehicle.

The towing eye can be screwed in at the front or rear of the vehicle.

Safety information

NOTICE

If the towing eye is not used as intended, there may be damage to the vehicle or to the towing eye. There is a risk of damage to property. Follow the notes on using the towing eye.

Storage

Depending on vehicle equipment, the towing eye may be stored in a bag as follows:

- In the cargo area under the cargo floor panel.
- In the cargo area on the left or right side.
- In the cargo area behind a side trim panel.

Using the towing eye

When using the towing eye, note the following:

- Use only the towing eye provided with the vehicle.
- Turn the towing eye at least 5 turns clockwise and screw it in as far as it will go. If necessary, tighten with a suitable object.
- After use, unscrew the towing eye counter-clockwise.
- Use the towing eye for towing on paved roads only.
- Avoid lateral loading of the towing eye, for instance do not lift the vehicle by the towing eye.
- Check the attachment of the towing eye in regular intervals.

Towing eye thread

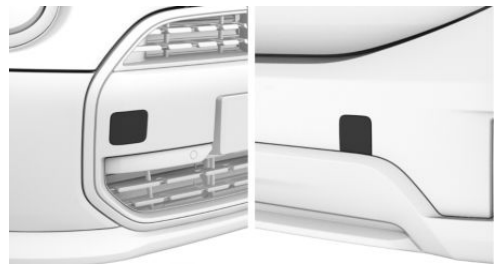

Press on the mark on the edge of the cover to push it out.

Tow-starting

Do not tow-start the vehicle.



Start the engine by jump-starting, if possible.

Have the cause of starting issues corrected by an authorized service center or another qualified service center or repair shop.

Additional information:

Jump-starting, refer to page [336](#).

Vehicle care

Vehicle features and options

This chapter describes model-specific equipment, systems, and functions that are currently available, or may become available in the future, even if they are not present in the vehicle.

Additional information:

Vehicle equipment, refer to page 8.

Washing the vehicle

General information

The vehicle must be washed more frequently, especially in the winter. Intense contamination and road salt can damage the vehicle.

Foreign objects, e.g. leaves or snow, must be removed from the area below the windshield on a regular basis. The wipers can be folded down in order to clean the windshield completely.

Additional information:

Fold-out position of the wipers, refer to page 159.

Safety information

NOTICE

When washing with an open fuel filler flap, damage may occur. There is a risk of damage to property. Close the fuel filler flap before washing. Clean dirt behind the fuel filler flap with a cloth.

Steam-jet cleaner and high pressure cleaner

Safety information

NOTICE

When cleaning with high pressure cleaners, components can be damaged due to the pressure or temperatures being too high. There is a risk of damage to property. Maintain sufficient distance and do not spray too long continuously. Follow the operating instructions for the high pressure cleaners.

Distances and temperature

When using a steam/high-pressure cleaner, maintain the following distances and temperatures:

- Maximum temperature: 140 °F/60 °C.
- Minimum distance from sensors, cameras, seals and lights: 12 inches/30 cm.
- Minimum distance from glass sunroof: 31.5 in/80 cm.

Automatic car washes or car washes

Safety information

NOTICE

Improper use of automatic car washes can cause damage to the vehicle. There is a risk of damage to property. Follow the following instructions:



- Give preference to cloth car washes or those that use soft brushes in order to avoid paint damage.
- Note the permissible vehicle dimensions for the car wash.
- Do not drive through a car wash with guide rails higher than 4 in/10 cm to avoid damage to the body.
- Observe the tire width of the guide rail to avoid damage to tires and rims.
- Fold in exterior mirrors to avoid damage to the exterior mirrors.
- Deactivate the wiper and, if necessary, rain sensor to avoid damage to the window wiper system.
- Take off all removable attachments, e.g., antennas.

Driving into a car wash

NOTICE

Selector lever position P is automatically engaged when standby state is switched off. The wheels are blocked. There is a risk of damage to property. Do not switch off standby if the vehicle is meant to coast, e.g., in a car wash.

In a car wash, the vehicle must be able to roll freely.

Some car washes do not permit persons in the vehicle. The vehicle cannot be locked from the outside when in selector lever position N. A signal sounds when an attempt is made to lock the vehicle.

Additional information:

Rolling or pushing the vehicle, refer to page 119.

Driving out of a car wash

Ensure that the vehicle key is in the car.

Turn on drive-ready state.

Additional information:

Drive-ready state, refer to page 41.

Lights

Do not rub wet lights dry, and do not use abrasive or acidic cleaning agents or cleaning agents containing alcohol.

Soak the area soiled by insects with an insect remover and rinse with water.

Thaw ice with de-icing spray, do not use an ice scraper.

After washing the vehicle

After washing the vehicle, apply the brakes briefly to dry them. Otherwise, their braking effect may be reduced. The heat generated while braking dries the brake disks and brake pads and protects them from corrosion.

Completely remove all wash residue, e.g., smearing, on the window glass to ensure sufficient visibility and to reduce wiper noise and wiper blade wear.

Vehicle care

Vehicle care products

General information

The manufacturer recommends using vehicle care and cleaning agents from MINI. Suitable vehicle care products are available from an authorized service center or another qualified service center or repair shop.

Safety information

Warning

Cleaning agents can contain substances that are dangerous and harmful to your health. There is a risk of injury and risk of damage to property. When cleaning the interior, open the doors or windows. Only use cleaning agents that are intended for cleaning the respective component. Follow the instructions on the packaging.

Vehicle paintwork

General information

Regular vehicle care contributes to driving safety and value retention. Environmental influences in areas with elevated air pollution or natural contaminants can affect the vehicle paintwork. Environmental influences include tree resin or pollen, for example.

To prevent paint alteration and discoloration, remove corrosive substances immediately. Corrosive substances include spilled fuel, oil, grease, or bird droppings, for example.

Matte paintwork

Only use cleaning and care products suitable for vehicles with matte paintwork.

Leather care

Dust and crumbs can work into pores and folds, causing heavy abrasion and premature degradation of the leather surface.

Clean leather regularly with a damp cloth or vacuum cleaner.

Certain clothes and other influences can cause discoloration of the leather. To prevent discoloration, clean and maintain the leather roughly every two months.

Clean light-colored leather more frequently because contamination on such surfaces is substantially more visible.

Use leather care products to preserve the protective layer of the leather.

To prevent leather alteration and discoloration, remove corrosive substances immediately. Corrosive substances include sunscreen, for example.

Synthetic leather care

Dust and crumbs can work into pores and folds, causing heavy abrasion and premature degradation of the artificial leather surface.

Clean synthetic leather regularly with a damp microfiber cloth or vacuum cleaner. In case of major soiling, use a moist soft sponge or microfiber cloth with suitable interior cleaners.

To prevent artificial leather alteration and discoloration, remove corrosive substances immediately. Corrosive substances include sunscreen, for example.

Fabric care

General information

In case of major soiling, use a moist soft sponge or microfiber cloth with suitable interior cleaners.

To prevent material alteration and discoloration, remove corrosive substances immediately. Corrosive substances include sunscreen, for example.

Safety information

NOTICE

Open hook and loop fasteners on articles of clothing can damage the seat covers and other cloth upholstery in the vehicle. There is a risk of damage to property. Ensure that any Velcro® fasteners are closed.

Upholstery material care

Vacuum the cushions regularly with a vacuum cleaner. Clean extensively down to the seams. Avoid rubbing the material vigorously.

Textile care

Using a damp microfiber cloth, clean the fabric regularly.

Caring for special components

Displays, operating elements, and projection screen of the Head-up display

NOTICE

Surfaces can be damaged by improper cleaning, e.g., by using chemical cleaners, or from moisture or liquid of any kind. Physical damage to the material is possible.

- Avoid pressure that is too high and do not use any scratching materials.
- Use a dry, clean antistatic microfiber cloth for cleaning displays.
- Clean the operating elements and, depending on vehicle equipment, the projection screen of the Head-up display with a damp microfiber cloth and standard household dish soap.

Light-alloy wheels

Corrosive, acidic, or alkaline cleaning agents can damage the rim surface and the protective layer on adjacent components, e.g., the brakes.

When cleaning the vehicle, use only neutral rim cleaners with a pH value of 5 to 9. Do not use abrasive cleaning agents or steam-jet cleaners above 140 °F/60 °C. Follow instructions given by the manufacturer.

After cleaning, apply the brakes briefly to dry them. The heat generated while braking dries the brake disks and brake pads and protects them from corrosion.

Chrome surfaces

Carefully clean chrome-like surfaces, especially if exposed to road salt, using plenty of water and adding auto shampoo as needed.

Rubber components

Environmental influences can cause surface contamination of rubber parts and a loss of shine. Use only water and suitable cleaning agents for cleaning.

Treat especially worn rubber parts with rubber care products at regular intervals. To avoid damage or noise, use care products containing silicon to maintain the rubber sealing rings.

Wiper blades

The wiper blades are cleaned by using the window washer system.

To prevent a reduction in wiper quality, avoid cleaning the wiper blades manually unless necessary.

Fine wood parts

Clean the fine wood veneer and fine wood components with a damp cloth. Then dry with a soft cloth.

Plastic components

NOTICE

Solvent cleaners that contain alcohol or solvents such as lacquer thinners, cold cleaning agents, fuel and such, can damage plastic parts. There is a risk of damage to property. Clean with a microfiber cloth. Dampen the cloth lightly with water, if needed.

When cleaning plastic parts, make sure that no fabric parts, e.g., the headliner, become wet.

Seat belts

Warning

Chemical solvent cleaners can destroy the fabric of the seat belts and lead to seat belts no longer having their protective effect. There is a risk of injury or danger to life. Use only a mild soap solution for cleaning the seat belts.

The seat belts should be cleaned for safety reasons. Dirty belt straps impede the reeling action and thus should be avoided for safety reasons.

Use only a mild soap solution for cleaning the installed belt straps.

Seat belts should only be allowed to retract if they are dry.

Carpets and floor mats

Warning

Objects in the driver's footwell can limit the pedal travel or block a depressed pedal. There is a risk of accident. Stow objects in the vehicle such that they are secured and cannot enter into the driver's footwell. Use floor mats that are suitable for the vehicle

and can be safely attached to the floor. Do not use loose floor mats and do not layer several floor mats. Make sure that there is sufficient clearance for the pedals. Ensure that the floor mats are securely fastened again after they were removed, for instance for cleaning.

The floor mats can be removed from the interior for cleaning.

If the carpets are heavily soiled, clean them with a microfiber cloth and water or a fabric cleaner. Rub back and forth in the direction of travel to prevent the carpet from becoming matted.

Sensors and camera lenses

General information

To clean sensors and camera lenses, use a cloth moistened with a small amount of glass detergent.

Cleaning the rearview camera

When the rear window is cleaned, the rearview camera is also cleaned automatically.

Technical data

Vehicle features and options

This chapter describes model-specific equipment, systems, and functions that are currently available, or may become available

in the future, even if they are not present in the vehicle.

Additional information:

Vehicle equipment, refer to page 8.

General information

The technical data and specifications in the Owner's Manual are used as guidance values. Vehicle-specific data may deviate from this, for instance due to the optional equipment chosen, national-market version, or country-specific measuring process. More

specific values can be obtained in approval documents, on the vehicle info label, or from an authorized service center or another qualified service center or repair shop.

Dimensions

The dimensions can vary depending on the model version, equipment version or country-specific measurement procedure.

The height of the vehicle can also differ, e.g., due to tires and vehicle load.

MINI COOPER		
Width with mirrors	in/mm	77.6/1,970
Width without mirrors	in/mm	68.7/1,744
Height	in/mm	56.4/1,432
Length	in/mm	152.6/3,877
Wheelbase	in/mm	98.2/2,495
Turning radius diameter	ft/m	36.4/11.1

Weights

MINI COOPER S		
Permissible gross mass	lbs/kg	3,825/1,735
Payload	lbs/kg	778/353
Approved front axle weight	lbs/kg	2,238/1,015
Approved rear axle weight	lbs/kg	1,797/815

Filling capacities

MINI COOPER		
Fuel tank, approx.	US gal/liters	11.6/44.0

Observe further information on fuel quality, refer to page [318](#).

Additional information:

Follow the recommendation for fuel.

Fuel recommendation, refer to page [318](#).

Appendix

General information

Any updates to the Owner's Manual of the vehicle are listed here.

Everything from A to Z

Index

0-9

3D view [226](#)

A

ABS, see Antilock Braking System [193](#)
 Acceleration Assistant, see Launch Control [122](#)
 Accessories and parts [10](#)
 Accident Assistance, see MINI Accident Assistance [334](#)
 Accident prevention, see Active Protection [190](#)
 Activated carbon filter, see Interior filter [251](#)
 Activation points, panorama view [227](#)
 Activation word [50](#)
 Active Blind Spot Detection [182](#)
 Active Cruise Control, Distance Control, see Speed control systems [199](#)
 Active Guard, see Collision warning systems [165](#)
 Active Park Distance Control [233](#)
 Active Protection [190](#)
 Adaptive lighting functions [154](#)
 Adaptive suspension [243](#)
 Adding engine oil types [321](#)
 Additional camera view displays [221](#)
 Additives, engine oil types [321](#)
 Adjusting driving dynamics, see MINI Modes [124](#)
 Adjusting speed to route [216](#)
 Advanced Real Time Traffic Information, see Owner's Manual for Navigation, Entertainment, Communication [6](#)
 After run of fan, see Exhaust gas particulate filter [275](#)
 Airbags [161](#)
 Airbags, warning light [163](#)

Air circulation, see Recirculated-air mode [248](#)
 Air conditioning, climate [247](#)
 Air distribution, manual [247](#)
 Air drying, see air conditioning [247](#)
 Air flow, automatic climate control [247](#)
 Air outlets, see Ventilation [251](#)
 Air pressure, tires [286](#)
 Air quality [251](#)
 Air vent, see Ventilation [251](#)
 Alarm, avoiding [87](#)
 Alarm system [85](#)
 All-season tires, see Winter tires [293](#)
 All-season tires, tread [291](#)
 Amazon Alexa Car Integration [53](#)
 Ambient light [156](#)
 Android Auto, see Owner's Manual for Navigation, Entertainment, Communication [6](#)
 Antifreeze, see Washer fluid [323](#)
 Antilock Braking System [193](#)
 Anti-theft protection, lug bolt lock [312](#)
 Anti-trap mechanism, glass sunroof [92](#)
 Anti-trap mechanism, windows [89](#)
 Apple CarPlay, see Owner's Manual for Navigation, Entertainment, Communication [6](#)
 Applications, see Owner's Manual for Navigation, Entertainment, Communication [6](#)
 Apps, see Owner's Manual for Navigation, Entertainment, Communication [6](#)
 Aquaplaning [276](#)
 Assistance, MINI [332](#)
 Assistance with breakdown [332](#)
 Assisted Driving Mode, lane keeping, see Speed control systems [199](#)
 Assisted View [145](#)
 Audio player, see Owner's Manual for Navigation, Entertainment, Communication [6](#)
 Audio, see Owner's Manual for Navigation, Entertainment and Communication [6](#)

Authorized service center, see MINI Accident Assistance [334](#)
Authorized service center, see MINI Roadside Assistance [333](#)
AUTO H, see Automatic Hold [128](#)
Automatic camera perspective [224](#)
Automatic climate control [244](#)
Automatic control, headlight [151](#)
Automatic Curb Monitor, exterior mirror [105](#)
Automatic deactivation, front-seat passenger airbags [163](#)
Automatic dimming, see Automatic High Beam Assistant [148](#)
Automatic headlight control [151](#)
Automatic High Beam Assistant [148](#)
Automatic Hold [128](#)
Automatic lights mode [154](#)
Automatic locking [84](#)
Automatic Parking Assistant [235](#)
Automatic program, automatic climate control [245](#)
Automatic time setting [146](#)
Automatic transmission, see Steptronic transmission [118](#)
Automatic unlocking [84](#)
Automatic wiper system, see Rain sensor [158](#)
AUTO program, automatic climate control [245](#)
Auto Start/Stop function [115](#)
Axle loads, approved [347](#)

B

Backrest curvature, see Lumbar support [97](#)
Backrest, seats [94](#)
Backrest tilt [96](#)
Back-up Assistant [240](#)
Balance Mode, see MINI Modes [124](#)
Bandages, see First-aid kit [332](#)
Bar for tow-starting/towing [338](#)
Battery, disposal [331](#)
Battery, vehicle [329](#)
Being towed, see Tow-starting and towing [337](#)

Belts, see Seat belts [99](#)
Beverage holder, front [264](#)
Beverage holder, rear [265](#)
Blind spot collision warning [182](#)
Blower, see Air flow [247](#)
Bluetooth audio, see Owner's Manual for Navigation, Entertainment, Communication [6](#)
Bluetooth connection, see Owner's Manual for Navigation, Entertainment, Communication [6](#)
Boost Control function [123](#)
Boost, see Boost Control [123](#)
Boost, see Sport Boost function [123](#)
Bottle holder, front, see Cup holder, front [264](#)
Bottle holder, rear, see Cup holder, rear [265](#)
Brake assistant [193](#)
Brake disks, see Brake system [274](#)
Brake pads, see Brake system [274](#)
Brake system [274](#)
Braking, information [277](#)
Breakdown assistance [332](#)
Break-in [274](#)
Break-in procedures [274](#)
Break recommendation, see Fatigue alert [191](#)
Brightness, Interaction Unit [47](#)
Button, central locking system [83](#)
Buttons on the steering wheel [30](#)
Button, SOS, see Intelligent emergency call [334](#)
Button, Start/Stop, see Start/Stop button [115](#)
Bypassing, see Jump-starting [336](#)

C

Cable for tow-starting/towing [338](#)
Calibration of the front seats [98](#)
California Proposition 65 Warning [10](#)
Camera cleaning [345](#)
Camera lenses, care [345](#)
Camera perspective, automatic [224](#)
Camera perspective, semi-automatic [224](#)
Camera, rearview camera [223](#)

- Cameras, see Vehicle sensors **34**
- Camera view aid lines **221**
- Care **341**
- Care, displays, screens **344**
- Care, Head-up display **344**
- Care, light-alloy wheels **344**
- Care, vehicle **342**
- Cargo **267**
- Cargo area **267**
- Cargo area, enlarging **270**
- Cargo cover **271**
- Car key, see Vehicle key **67**
- Carpet, care **345**
- Car seats, see Transporting children safely **109**
- Car wash **341**
- Car wash, automatic **341**
- Car wash view **226**
- Catalytic converter, see Hot exhaust gas system **275**
- CBS, see Condition Based Service **325**
- Cell phone, see Owner's Manual for Navigation, Entertainment and Communication **6**
- Center console **32**
- Central locking switch, see Central locking system **83**
- Central locking system **83**
- Changes, technical, see For Your Own Safety **9**
- Change, wheels and tires **292**
- Changing parts **328**
- Changing wheels **310**
- Charging cradle **257**
- Charging smartphone, see Wireless charging tray **257**
- Charging tray for smartphones, see Wireless charging tray **257**
- Chassis number, see Vehicle identification number **14**
- Check Control **133**
- Checking the engine oil level, electronic **320**
- Checking the oil level, electronic **320**
- Children, seating position **109**
- Children, transporting safely **109**
- Child restraint seats **109**
- Child restraint system LATCH **112**
- Child restraint systems, mounting **110**
- Child restraint systems, see Transporting children safely **109**
- Child seat installation **110**
- Child seat, mounting **110**
- Child seats, see Transporting children safely **109**
- Chrome-plated surfaces, care **344**
- Chrome surfaces, care **344**
- Cleaning, see Care **342**
- Climate control **244**
- Closing with smartphone, see MINI Digital Key **80**
- Closing with the Key Card **79**
- Clothes hooks **265**
- Coasting **280**
- Coasting with idling engine **280**
- Coat hooks **265**
- Collision warning systems **165**
- Comfort Access **75**
- Comfort entry **99**
- Comfort exit **99**
- Communication, see Owner's Manual for Navigation, Entertainment and Communication **6**
- Comparison of entries, see Entry comparison **46**
- Compartments in the doors **264**
- Compressor **295**
- Condensation water under the parked vehicle **278**
- Condensation, windshield **249**
- Condition Based Service **325**
- Connecting mobile devices to the vehicle **53**
- Connection, electrical devices, see Sockets **256**
- Contacts, see Owner's Manual for Navigation, Entertainment, Communication **6**
- Continued driving with a flat tire, see Tire Pressure Monitor **300**
- Continued driving with flat tire, see Flat tire monitor **307**
- Control display, see MINI Interaction Unit **43**
- Control systems, driving stability **193**

Coolant 322
Coolant level 323
Coolant temperature, see Engine temperature 141
Cooling, maximum 248
Cooling system 322
Core Mode, see MINI Modes 124
Cornering light 154
Corrosion, brake disks 278
Cosmetic mirror 256
Cross Traffic Warning 185
Cruise Control, Cruise Control, see Speed control systems 199
Cruise Control, see Speed control systems 199
Cruising range 143
Cup holder, front 264
Cup holder, rear 265
Customer support 332

D

Damage, tires 291
Dashboard 30
Dashcam, see Drive Recorder 187
Data memory 11
Data protection, settings 59
Data, see Personal data, deleting 59
Data, technical 346
Date 146
Day, see Date 146
Daytime driving lights 153
Daytime running lights 153
Deep sleep mode 40
Defrosting, windshield 249
Deleting, personal data 59
Departure schedule, see Pre-ventilation 252
Departure time, preconditioning via Remote Engine Start 255
Departure time, pre-ventilation 252
Destination input 6
Diagnostic connection 326
Diagnostic socket 326
Digital Key 80
Digital Key, see MINI Digital Key 80
Dimensions 346
Dimmable interior mirror 106
Dimming exterior mirror 105
Direct dial buttons, see Shortcuts 46
Display and operating concept 43
Display, GREEN Mode 281
Display lighting, see Instrument lighting 154
Displays 131
Displays and icons 8
Display speed limit, see Speed Limit Info 197
Disposal, coolant 323
Disposal, vehicle battery 331
Distance Control, see Speed control systems 199
Distance to vehicle driving ahead, see Speed control systems 199
Distance Warning, see Park Distance Control 230
Door handle lighting, see Welcome lights 152
Door opening angle 228
Drive-off monitoring 234
Drive-off support 196
Drive power reduced 140
Driver Assistance, parking, see Parking assistance systems 218
Driver assistance systems 197
Drive-ready state, see Operating state of vehicle 39
Drive Recorder 187
Driver profiles 60
Driver profiles, welcome screen 60
Drive sound, see MINI Sound 243
Driving 115
Driving Assistant, see Collision warning systems 165
Driving comfort 243
Driving Dynamics Control, see MINI Modes 124
Driving dynamics, setting 195
Driving information 48
Driving mode, GREEN 281
Driving Mode, see MINI Modes 124
Driving notes 274
Driving off, see Drive-off support 196

Driving stability control systems [193](#)
 Driving through flood [276](#)
 Driving through water [276](#)
 Driving tips, see General driving notes [275](#)
 DSC, see Dynamic Stability Control [193](#)
 DTC, see Setting for increased driving dynamics [195](#)
 Dynamic shock absorber, see Adaptive suspension [243](#)
 Dynamic Stability Control [193](#)
 Dynamic Traction Control, see Setting for increased driving dynamics [195](#)

E

Efficiency Coach, Green Mode [282](#)
 Electronic oil measurement [320](#)
 Electronic stability program, see Dynamic Stability Control [193](#)
 Emergency braking, see PostCrash iBrake [191](#)
 Emergency call [334](#)
 Emergency release, fuel filler flap [285](#)
 Emergency release, transmission lock [121](#)
 Emergency service, see MINI Roadside Assistance [333](#)
 Emissions, see Exhaust emissions [326](#)
 Energy savings, see Gear shift indicator [142](#)
 Engine, automatic Start/Stop function [115](#)
 Engine compartment [315](#)
 Engine coolant [322](#)
 Engine idling when driving, see Coasting [280](#)
 Engine oil filler neck [320](#)
 Engine oil, refilling [320](#)
 Engine oil types to add [321](#)
 ENGINE, see Drive-ready state [41](#)
 Engine sound, see MINI Sound [243](#)
 Engine start, see Drive-ready state [41](#)
 Engine start, see Jump-starting [336](#)
 Engine stopping, see Drive-ready state [41](#)
 Engine temperature [141](#)
 Entering a destination, see Owner's Manual for Navigation, Entertainment, Communication [6](#)

Entering an address, navigation, see Owner's Manual for Navigation, Entertainment and Communication [6](#)
 Entertainment, see Owner's Manual for Navigation, Entertainment and Communication [6](#)
 Entertainment, selection list in the instrument cluster [141](#)
 Entry assistance, exit assistance [99](#)
 Entry comparison [46](#)
 Error indicators, see Check Control [133](#)
 ESP, see Dynamic Stability Control [193](#)
 Evasion Assistant, see Forward Collision Mitigation [167](#)
 Event Data Recorder EDR [14](#)
 Exchange, wheels and tires [292](#)
 Exhaust emissions [326](#)
 Exhaust gas particulate filter [275](#)
 Exhaust gas system [275](#)
 Exhaust, see Exhaust gas system [275](#)
 Exit Warning [176](#)
 Experience switch, see MINI Modes [124](#)
 Exterior lighting, locked vehicle [153](#)
 Exterior mirror [104](#)
 Exterior mirror, Automatic Curb Monitor [105](#)
 Exterior mirror cameras, see Vehicle sensors [34](#)
 External start, see Jump-starting [336](#)
 Eye for towing [339](#)

F

Factory settings, see Vehicle data, resetting [60](#)
 Failure message, see Check Control [133](#)
 Fan after run, see Exhaust gas particulate filter [275](#)
 Fastening seat belts, see Seat belts [99](#)
 Fatigue Alert [191](#)
 Fatigue warner, see Fatigue Alert [191](#)
 Fault indicators, see Check Control [133](#)
 Filler neck for engine oil [320](#)
 Filter, see Interior filter [251](#)
 Fine wood parts, care [344](#)
 First-aid kit [332](#)

Flat tire, changing wheels [310](#)
Flat tire, continued driving, see Flat tire monitor [307](#)
Flat tire, continued driving, see Tire Pressure Monitor [300](#)
Flat tire message, see Flat tire monitor [308](#)
Flat tire message, see Tire Pressure Monitor [303](#)
Flat tire monitor [307](#)
Flat tire, repairing [294](#)
Flat tire, see Flat tire monitor [307](#)
Flat tire, see Tire Pressure Monitor [300](#)
Flat tire warning light, see Flat tire monitor [308](#)
Flat tire warning light, see Tire Pressure Monitor [303](#)
Floor carpet, care [345](#)
Floor mats, care [345](#)
Fold-away position, wiper [159](#)
Fold-out position [159](#)
Foot brake [277](#)
Forward Collision Mitigation [167](#)
Forward Collision Warning, see Forward Collision Mitigation [167](#)
For Your Own Safety [9](#)
Front airbags [161](#)
Front camera, see Vehicle sensors [34](#)
Front lights, replacing, see Lights and bulbs [329](#)
Front passenger's side exterior mirror, tilting down, see Automatic Curb Monitor [105](#)
Front passenger airbags, automatic deactivation [163](#)
Front radar sensor, see Vehicle sensors [34](#)
Front-seat passenger airbag, indicator light [164](#)
Front seats [94](#)
Fuel [318](#)
Fuel filler cap [284](#)
Fuel filler flap [284](#)
Fuel gauge [144](#)
Fuel quality [318](#)
Fuel recommendation [318](#)
Fuel tank, see Filling capacity [347](#)
Fuses [331](#)

G

Gasoline [318](#)
Gasoline particulate filter, see Exhaust gas particulate filter [275](#)
Gasoline particulate filter, see Exhaust particulate filter [275](#)
Gasoline quality [319](#)
Gear change, Steptronic transmission [118](#)
General driving notes [275](#)
Glare shield, see Sun visor [256](#)
Glass sunroof [90](#)
Glass sunroof, initializing the glass sunroof and sun protection [93](#)
Glove compartment [263](#)
Go Kart Mode, see MINI Modes [124](#)
GPS navigation, navigation, see Owner's Manual for Navigation, Entertainment, Communication [6](#)
GREEN Mode [281](#)
Green Mode, see MINI Modes [124](#)
Gross vehicle weight, approved [347](#)
Guest profile, see MINI ID [60](#)

H

Handbrake, see Parking brake [126](#)
Hands-free device, see Owner's Manual for Navigation, Entertainment, Communication [6](#)
Hands-free system [6](#)
Hazard warning system [332](#)
Head airbag [162](#)
Headlight control, automatic [151](#)
Headlight flasher [147](#)
Headlight glass [329](#)
Headlights, care [342](#)
Headlights, replacing, see Lights and bulbs [329](#)
Headlights, turning up, dimming, see Automatic High Beam Assistant [148](#)
Headliner [33](#)
Head restraints and seats [94](#)
Head restraints, front [101](#)
Head restraints, rear [102](#)

Head-up display [132](#)
 Head-up display, care [344](#)
 Head-up display, store position, see Memory function [106](#)
 Heated steering wheel [250](#)
 Heavy cargo, stowing [268](#)
 Height, vehicle [346](#)
 High-beam headlights [147](#)
 Hills [277](#)
 Homepage, see Internet [7](#)
 Hood [315](#)
 Horn [30](#)
 Hot exhaust gas system [275](#)
 Hotline, see Customer support [332](#)
 Hour, see Time [146](#)

I

iBrake PostCrash [191](#)
 Ice warning, see Outside temperature [145](#)
 Icons and displays [8](#)
 Identification marks, tires [289](#)
 Identification number, see Vehicle identification number [14](#)
 Idle state, see Operating state of vehicle [39](#)
 Illustration, MINI Interaction Unit [45](#)
 Inclination [96](#)
 Indicator light, front-seat passenger airbag [164](#)
 Indicator lights [134](#)
 Individual air distribution [247](#)
 Individual settings, see MINI ID [60](#)
 Inductive charging, smartphone, see Wireless charging tray [257](#)
 Information [6](#)
 Information on Driver Assistance, displaying, see Assisted View [145](#)
 Initialization, see flat tire monitor [308](#)
 Input, MINI Interaction Unit [45](#)
 Installation of child restraint systems [110](#)
 Instrument cluster, see Driving information [48](#)
 Instrument lighting [154](#)
 Integrated key [69](#)
 Integrated Owner's Manual in the vehicle [6](#)
 Intelligent emergency call [334](#)

Intended use [9](#)
 Interaction Unit [43](#)
 Interior camera [259](#)
 Interior equipment [256](#)
 Interior filter [251](#)
 Interior lights [155](#)
 Interior lights, locked vehicle [153](#)
 Interior mirror [106](#)
 Interior mirror, automatic dimming feature [106](#)
 Interior mirror, manually dimmable [105](#)
 Interior motion sensor [87](#)
 Internet page [7](#)
 Intersection Collision Warning, see Forward Collision Mitigation [167](#)
 Interval indicator, see Service notifications [146](#)

J

Jacking points [313](#)
 Jacking points for the vehicle jack [313](#)
 Joystick, Steptronic transmission [118](#)
 Jump-starting [336](#)
 Jump-starting terminals [336](#)
 Jump-start terminals [336](#)

K

Key Card [79](#)
 Keyless Go, see Comfort Access [75](#)
 Key, mechanical [69](#)
 Key, see Vehicle key [67](#)
 Kickdown, Steptronic transmission [118](#)
 Knee airbag [162](#)

L

Labeling [289](#)
 Lane boundary [178](#)
 Lane departure warning [178](#)
 Lane keeping, Assisted Driving Mode, see Speed control systems [199](#)
 Lane lines, additional camera view displays [221](#)

- Lane threshold, warning 178
Language, setting 51
LATCH child restraint system 112
Lateral Parking Aid 224
Launch Control 122
Leather care 343
LED headlights, changing, see Lights and bulbs 329
Length, vehicle 346
Letters and numbers, entering 45
Light-alloy wheels, care 344
Light in exterior mirror, see Active Blind Spot Detection 182
Light in exterior mirror, see Cross Traffic Warning 185
Lighting 150
Light replacement, see Lights and bulbs 329
Lights 147
Lights and bulbs 329
Lights, care 342
Light switch 150
List, instrument cluster, see Selection lists 141
Load 268
Loading 267
Loading the cargo area, see Cargo 267
Local time, see Time 146
Locking, see Opening and Closing 67
Locking, settings 84
Lock, lug bolts 312
Long stationary periods, see Deep sleep mode 40
Loop, see Towing eye 339
Low-beam headlights 151
Lower back support, see Lumbar support 97
Lug bolt lock 312
Luggage rack, refer to Roof bars 278
Lumbar massage, see Seat massage 97
Lumbar support 97
- ## M
- Maintenance 325
Maintenance recommendation, see Condition Based Service 325
Maintenance system 325
Make-up mirror 256
Malfunction, vehicle key 72
Manual brake, see Parking brake 126
Manually unlocking doors, see Integrated key 69
Manual mode, transmission 121
Map, see Owner's Manual for Navigation, Entertainment, Communication 6
Map update, see Owner's Manual for Navigation, Entertainment, Communication 6
Marking, run-flat tire 294
Matte paintwork 343
Matt paint, care 343
Maximum cooling 248
Maximum speed, display, see Speed Limit Info 197
Maximum speed, winter tires 293
Measurement indicator, see Driving information 48
Medical supplies, see First-aid kit 332
Memory function 106
Messages, see Check Control 133
Messages, see Owner's Manual for Navigation, Entertainment, Communication 6
Microfilter, see Interior filter 251
MINI Accident Assistance 334
MINI Connected, see Owner's Manual for Navigation, Entertainment, Communication 6
MINI Digital Key 80
MINI EXPERIENCE Modes, see MINI Modes 124
MINI ID 60
MINI Interaction Unit 43
MINI maintenance system, see Maintenance system 325
MINI Modes 124
Minimum tread depth, tires 291
MINI Roadside Assistance 333
MINI Sound 243
Minute, see Time 146
Mobile communications in the vehicle 276
Mobile devices, connecting 53
Mobile phone, see Owner's Manual for Navigation, Entertainment and Communication 6

Mobile Service, see MINI Accident Assistance [334](#)
 Mobile Service, see MINI Roadside Assistance [333](#)
 Mobility system, see Tire repair set [295](#)
 MODE button, see Speed control systems [199](#)
 Modifications, technical, see For Your Own Safety [9](#)
 Moisture in headlight, see Headlight glass [329](#)
 Mounting of child restraint systems [110](#)
 Mug holder, front, see Cup holder, front [264](#)
 Mug holder, rear, see Cup holder, rear [265](#)
 Multi-function steering wheel [30](#)
 Multifunction steering wheel, buttons [30](#)

N

Neck restraints, front, see Head restraints, front [101](#)
 Neck restraints, rear, see Head restraints, rear [102](#)
 Neutral cleaner, see Light-alloy wheels, care [344](#)
 Notifications, see Owner's Manual for Navigation, Entertainment, Communication [6](#)
 Nylon rope for tow-starting/towing [338](#)

O

OBD, see On-board diagnosis [326](#)
 Obstacle marking, additional camera view displays [221](#)
 Octane number, see Gasoline quality [319](#)
 OFF indicator, see Standby and drive-ready state [141](#)
 Oil filler neck [320](#)
 Oil, refilling [320](#)
 Oil service interval, see Service notifications [146](#)
 Oil types to add, engine [321](#)
 Old battery [331](#)
 On-board diagnosis [326](#)
 Onboard toolkit [328](#)

On-call service, see MINI Accident Assistance [334](#)
 On-call service, see MINI Roadside Assistance [333](#)
 One-touch signaling [147](#)
 Opening and closing [67](#)
 Opening with smartphone, see MINI Digital Key [80](#)
 Opening with the Key Card [79](#)
 Operating elements, center console [32](#)
 Operating fluids [318](#)
 Operating menus, MINI Interaction Unit [43](#)
 Operating principle of MINI Interaction Unit [43](#)
 Operating state of vehicle [39](#)
 Operating temperature, see Engine temperature [141](#)
 Operation via voice [49](#)
 Optional equipment, see Vehicle equipment [8](#)
 Outside temperature [145](#)
 Overheating of the engine, see Engine temperature [141](#)
 Overwintering, see Long-term vehicle storage [326](#)

P

Paint, vehicle care [343](#)
 Paintwork [343](#)
 Panic alarm, see Panic mode [86](#)
 Panic mode [86](#)
 Panorama View [227](#)
 Panorama View, see Panorama View [227](#)
 Panoramic glass sunroof, see Glass sunroof [90](#)
 Park Distance Control [230](#)
 Parking aid lines, additional camera view displays [221](#)
 Parking assistance systems [218](#)
 Parking assistant [235](#)
 Parking Assistant Plus, see Parking assistance systems [218](#)
 Parking Assistant, see Park Distance Control [230](#)

Parking Assistant, see Parking assistance systems 218

Parking brake 126

Parking brake function, see Active Park Distance Control 233

Parking lights 152

Parking with Automatic Hold 128

Particulate filter, see Exhaust gas particulate filter 275

Parts and accessories 10

Pathway lighting 153

Pathway lighting, turning on 153

Payload 268

Payload, technical data 347

PDC, see Park Distance Control 230

Pedestrian Warning, see Forward Collision Mitigation 167

Personal Assistant 49

Personal data, deleting 59

Personal Mode, see MINI Modes 124

Personal profile, see MINI ID 60

Personal settings 59

Physical units, see Setting units of measurement 146

Plastic parts, care 345

Pollutant emissions, see Exhaust emissions 326

PostCrash iBrake 191

Power failure 330

Power gauge 140

Power interruption 330

Power windows 87

Pre-conditioning 253

Pressure monitor, tire, see Tire Pressure Monitor 300

Pressure, tires 286

Pressure warning, see Flat tire monitor 307

Pressure warning, see Tire Pressure Monitor 300

Pre-ventilation 252

Prevention of rear-end collision, see Rear-end collision preparation 184

Protective function, glass sunroof, see Anti-trap mechanism 92

Protective function, windows, see Anti-trap mechanism 89

R

Racing track 279

Radar sensors, see Vehicle sensors 34

Radiator fan, see Exhaust gas particulate filter 275

Radiator fluid 322

Radio information, see Owner's Manual for Navigation, Entertainment, Communication 6

Radio, see Owner's Manual for Navigation, Entertainment and Communication 6

Radio stations, see Owner's Manual for Navigation, Entertainment, Communication 6

Rain sensor 158

Rain sensor mode 158

READY indicator, see Standby and drive-ready state 141

Rear automatic climate control 244

Rear-end collision preparation 184

Rear lights, replacing, see Lights and bulbs 329

Rear seat backrests, folding down 270

Rearview camera 223

Rearview camera, see Vehicle sensors 34

Rear-view mirror, exterior 104

Rear-view mirror, interior 106

Rear window defroster 250

Rear window wiper, operation 159

Rear wiper 159

Recirculated-air mode 248

Recirculating air filter, see Interior filter 251

Recommended tire brands 292

Reduced drive power 140

Refueling 284

Release fuel filler flap, manual 285

Remote 3D View 229

Remote control, see Vehicle key 67

Remote Engine Start, see Stationary climate control 253

Remote services, see Owner's Manual for Navigation, Entertainment, Communication 6

Remote Software Upgrade 55

Renewal, wheels and tires 292

Replacement, wheels and tires [292](#)
 Replacing bulbs, see [Lights and bulbs 329](#)
 Replacing light diodes, see [Lights and bulbs 329](#)
 Replacing parts [328](#)
 Replacing the battery, vehicle key [68](#)
 Reporting safety malfunctions [15](#)
 Reserve warning, see [Range 143](#)
 Reservoir, washer fluid [323](#)
 Resetting, vehicle data [60](#)
 Reset, Tire Pressure Monitor [302](#)
 Reset, vehicle settings [60](#)
 Restricted Driving, see [MINI Digital Key 80](#)
 Retreaded tires [293](#)
 Reversing Assistant [240](#)
 Risk of collision when exiting [176](#)
 Roadside parking lights [152](#)
 Rolling to a stop with engine decoupled, see [Coasting 280](#)
 RON, see [gasoline quality 319](#)
 Roof bars [278](#)
 Roofliner [33](#)
 Roof luggage rack, refer to [Roof bars 278](#)
 Rope for tow-starting/towing [338](#)
 Route and Intersection Assistant, see [Adjusting speed to route 216](#)
 Route, navigation, see [Owner's Manual for Navigation, Entertainment, Communication 6](#)
 RSC, see [Runflat tires 294](#)
 Rubber components, care [344](#)
 Runflat tires [294](#)
 Runflat tires, see [Runflat tires 294](#)

S

Safe braking [277](#)
 Safe Exit, see [Exit warning 176](#)
 Safe Share function, see [MINI Digital Key 80](#)
 Safety and warning, see [Collision warning systems 165](#)
 Safety package, see [Active Protection 190](#)
 Safety systems, see [Airbags 161](#)
 Safety systems, see [Collision warning systems 165](#)

Satellite radio, see [Owner's Manual for Navigation, Entertainment, Communication 6](#)
 Saved stations, see [Owner's Manual for Navigation, Entertainment, Communication 6](#)
 Saving fuel [280](#)
 Sealant, see [Tire repair set 295](#)
 Seat belt reminder, see [Seat belt warning 100](#)
 Seat belts [99](#)
 Seat belts, care [345](#)
 Seat belt warning [100](#)
 Seat calibration [98](#)
 Seat heating [250](#)
 Seating position for children [109](#)
 Seat massage [97](#)
 Seats and head restraints [94](#)
 Seats, front [94](#)
 Securing, cargo [268](#)
 Selection list on the instrument cluster [141](#)
 Selector lever, Steptronic transmission [118](#)
 Semi-automatic camera perspective [224](#)
 Sensors, care [345](#)
 Service and warranty [10](#)
 Service notifications [146](#)
 Service notifications, see [Condition Based Service 325](#)
 Servotronic [196](#)
 SET button, see [Speed control systems 199](#)
 Setting the time, see [Time 146](#)
 Setting units of measurement [146](#)
 Shift lights [143](#)
 Shift paddles on the steering wheel [121](#)
 Shift point display [142](#)
 Shift point indicator, tachometer [143](#)
 Shift recommendation for fuel-efficient driving, see [Shift point display 142](#)
 Shortcuts, Interaction Unit [46](#)
 Side airbag [161](#)
 Side protection, see [Automatic camera perspective 224](#)
 Side view [225](#)
 Signaling, horn [30](#)
 Signals when unlocking, see [Confirmation signals 84](#)
 SIM Reader, see [Owner's Manual for Navigation, Entertainment, Communication 6](#)

- Sitting safely 94
- Slipperiness, see Outside temperature 145
- Slippery road, see Outside temperature 145
- Smallest turning circle, vehicle 346
- Smartphone, see Owner's Manual for Navigation, Entertainment and Communication 6
- Smartphone, using via voice control 52
- Snapshot camera, see Interior camera 259
- Snow chains 299
- Sockets, electrical devices 256
- Software Update, see Remote Software Upgrade 55
- Software Upgrade, see Remote Software Upgrade 55
- Soot particulate filter, see Exhaust gas particulate filter 275
- SOS button, see Intelligent emergency call 334
- Sound of engine, see MINI Sound 243
- Sound settings, see Owner's Manual for Navigation, Entertainment, Communication 6
- Sound system, see Owner's Manual for Navigation, Entertainment, Communication 6
- Speed control systems 199
- Speed indicator, see Driving data 48
- Speed Limit Assist 214
- Speed Limit Assistant 214
- Speed limit device, speed limiter, see Speed control systems 199
- Speed limit, display, see Speed Limit Info 197
- Speed limiter, manual, see Speed control systems 199
- Speed Limit Info 197
- Speedometer, see Driving data 48
- Speed warning 197
- Sport Boost function 123
- SPORT PLUS setting, see Setting for increased driving dynamics 195
- Sport program, transmission 118
- Stability control systems 193
- Standard equipment, see Vehicle equipment 8
- Standby state, see Operating state of vehicle 39
- Start/stop, automatic function 115
- Start/Stop button 115
- Start/Stop button, driving 115
- Starting aid terminals 336
- Starting, see Drive-ready state 41
- Starting the engine, see Drive-ready state 41
- Starting the engine with the Key Card 79
- Stationary climate control via Remote Engine Start 253
- Stationary periods, see Deep sleep mode 40
- Stations, see Owner's Manual for Navigation, Entertainment, Communication 6
- Status control display, tires 301
- Status information, MINI Interaction Unit 45
- Status of Owner's Manual 9
- Status, vehicle 144
- Steering column adjustment 106
- Steering support, see Servotronic 196
- Steering wheel, adjusting 106
- Steering wheel, buttons 30
- Steering wheel heating 250
- Steptronic Sport transmission, see Steptronic transmission 118
- Steptronic transmission 118
- Steptronic transmission with double clutch, see Steptronic transmission 118
- Stopping the engine, see Drive-ready state 41
- Storage compartments 263
- Storage, tires 294
- Store Mirror position, see Memory function 106
- Store seat position, see Memory function 106
- Store steering wheel position, see Memory function 106
- Storing the vehicle 326
- Stowage, cargo 268
- Summer tires, tread 291
- Sun visor 256
- Supplementary Owner's Handbooks 7
- Supplementary Owner's Manuals 7

Suspension [243](#)
 Switch cluster [32](#)
 Switches, see Dashboard [30](#)
 SYNC program, automatic climate control [249](#)
 System language, setting, see Language, setting [51](#)

T

Tachometer [140](#)
 Tachometer, see Driving data [48](#)
 Tail lights, replacing, see Lights and bulbs [329](#)
 Taking the vehicle out of service [326](#)
 Tank volume [347](#)
 Technical changes, see For Your Own Safety [9](#)
 Technical data [346](#)
 Telephone, see Owner's Manual for Navigation, Entertainment and Communication [6](#)
 Telephone, selection list in the instrument cluster [141](#)
 Teleservices, see Owner's Manual for Navigation, Entertainment, Communication [6](#)
 Temperature, automatic climate control [246](#)
 Temperature display, see outside temperature [145](#)
 Theft alarm system, see Alarm system [85](#)
 Tilt alarm sensor [87](#)
 Tilt, backrest [96](#)
 Tilting down, front passenger's side exterior mirror, see Automatic Curb Monitor [105](#)
 Time [146](#)
 Timeless Mode, see MINI Modes [124](#)
 Time of day, see Time [146](#)
 Time setting, automatic [146](#)
 Time zone [146](#)
 Tire brands, recommendation [292](#)
 Tire change [292](#)
 Tire damage [291](#)
 Tire identification marks [289](#)
 Tire inflation pressure [286](#)
 Tire marking [289](#)
 Tire pressure [286](#)
 Tire Pressure Monitor [300](#)

Tire pressure monitoring, see Flat tire monitor [307](#)
 Tire Pressure Monitor, reset [302](#)
 Tire pressure, tires [286](#)
 Tire pressure warning, see Flat tire monitor [307](#)
 Tire repair set [295](#)
 Tires and wheels [286](#)
 Tire sealant, see Tire repair set [295](#)
 Tire settings [300](#)
 Tires, run-flat [294](#)
 Tire tread [291](#)
 Tools [328](#)
 Tow bar [338](#)
 Towing [337](#)
 Towing eye [339](#)
 Tow rope [338](#)
 Tow-starting [337](#)
 Traction control system, see Dynamic Stability Control [193](#)
 Traffic bulletins, see Owner's Manual for Navigation, Entertainment, Communication [6](#)
 Transmission, see Steptronic transmission [118](#)
 Transporting children safely [109](#)
 Tread, tires [291](#)
 Trunk, see Cargo area [267](#)
 Turn indicators, see Turn signals [147](#)
 Turning circle lines, additional camera view displays [221](#)
 Turning circle, vehicle [346](#)
 Turn signal, indicator light [137](#)
 Turn signal, replacing bulbs, see Lights and bulbs [329](#)
 Turn signals [147](#)
 Turn Warning, see Forward Collision Mitigation [167](#)

U

Ultrasonic sensors, see Vehicle sensors [34](#)
 Unintended alarm, see Unintentional alarm, avoiding [87](#)
 Unintentional alarm, avoiding [87](#)

Units, see Setting units of measurement [146](#)
Unlocking, see Opening and Closing [67](#)
Unlocking, settings [84](#)
Unlocking the transmission lock, electronic [121](#)
Updates made after the editorial deadline [9](#)
Upgrade, see Remote Software Upgrade [55](#)
Upholstery material care [343](#)
Upper retaining strap, top tether [113](#)
USB audio, see Owner's Manual for Navigation, Entertainment, Communication [6](#)
USB port, position in vehicle [257](#)
Used battery, disposing of [331](#)
Use, intended [9](#)

V

Vanity mirror [256](#)
Vehicle battery [329](#)
Vehicle breakdown, see Breakdown assistance [332](#)
Vehicle care [342](#)
Vehicle care products [342](#)
Vehicle data, resetting [60](#)
Vehicle equipment [8](#)
Vehicle identification number [14](#)
Vehicle issues [332](#)
Vehicle key [67](#)
Vehicle key, additional [68](#)
Vehicle key, loss [68](#)
Vehicle laminated glass [276](#)
Vehicle paint, care [343](#)
Vehicle paintwork [343](#)
Vehicle sensors [34](#)
Vehicle status [144](#)
Vehicle storage [326](#)
Ventilation [251](#)
Ventilation, see Pre-ventilation [252](#)
Venting, see Ventilation [251](#)
Version Software, see Remote Software Upgrade [55](#)
Video recording, see Drive Recorder [187](#)
VIN, see Vehicle identification number [14](#)
Vivid Mode, see MINI Modes [124](#)
Voice activation system [49](#)

Voice control [49](#)
Voice recognition [49](#)
Volume, see Owner's Manual for Navigation, Entertainment, Communication [6](#)

W

Wake word [50](#)
Warning for crossing traffic [185](#)
Warning function for oncoming traffic, see Forward Collision Mitigation [167](#)
Warning function, rear-end collision [184](#)
Warning light in exterior mirror, see Active Blind Spot Detection [182](#)
Warning light in exterior mirror, see Cross Traffic Warning [185](#)
Warning lights [134](#)
Warning messages, see Check Control [133](#)
Warning systems for collision hazards [165](#)
Warning triangle [332](#)
Warning when exiting [176](#)
Warning when opening doors, see Exit Warning [176](#)
Warranty [9](#)
Warranty Booklet, see Warranty [9](#)
Washer fluid [323](#)
Washer nozzles, windshield [159](#)
Washing the vehicle [341](#)
Washing, vehicle [341](#)
Water on road [276](#)
Water, see Condensation water under the parked vehicle [278](#)
Website, see Internet [7](#)
Weights [347](#)
Welcome lights [152](#)
Welcome screen, driver profiles [60](#)
Wheelbase [346](#)
Wheel base, vehicle [346](#)
Wheel change [310](#)
Wheels and tires [286](#)
Wheels and tires, exchange [292](#)
Widgets, MINI Interaction Unit [44](#)
Width, vehicle [346](#)
Wi-Fi connection, see Owner's Manual for Navigation, Entertainment, Communication [6](#)

Wind deflector, defrosting [249](#)
Wind deflector, removing condensation [249](#)
Window, defrosting [249](#)
Windows, powered [87](#)
Windshield cleaning system, see Wiper system [157](#)
Windshield, defrosting [249](#)
Windshield, removing condensation [249](#)
Windshield washer fluid, see Washer fluid [323](#)
Windshield washer nozzles [159](#)
Windshield wipers, see Wiper system [157](#)
Winter storage, see Long-term vehicle storage [326](#)
Winter tires [293](#)
Winter tires, tread [291](#)
Wiper blades, replacing [328](#)
Wiper fluid, see Washer fluid [323](#)
Wiper, fold-away position [159](#)
Wipers, see Wiper system [157](#)
Wiper system [157](#)
Wireless charging, smartphone, see Wireless charging tray [257](#)
Wireless charging tray for smartphones [257](#)
Wood parts, care [344](#)
Wordmatch principle, see Entry comparison [46](#)

01405B37A59 ue



California Proposition 65 Warning

For vehicles sold in California:

California Proposition 65 Warning

 **WARNING**

Operating, servicing and maintaining a passenger vehicle or off-highway motor vehicle can expose you to chemicals including engine exhaust, carbon monoxide, phthalates, and lead, which are known to the State of California to cause cancer and birth defects or other reproductive harm. To minimize exposure, avoid breathing exhaust, do not idle the engine except as necessary, service your vehicle in a well-ventilated area and wear gloves or wash your hands frequently when servicing your vehicle. For more information go to www.P65Warnings.ca.gov/passenger-vehicle.

MINI MOTORER'S GUIDE APP.

YOUR DIGITAL VEHICLE INFORMATION.

The MINI Motorer's Guide app explains the equipment of your vehicle and offers further scopes and functions:



All information surrounding navigation, entertainment and communication

Photorealistic animations for various vehicle functions

Keyword search

360° view: Explore your vehicle interactively inside and out

Smart Scan for Apple iPhone: Icon and optical character recognition on the buttons in the vehicle

Available in more than 30 languages



Can be used offline after download



01405B37A59 ue